

PRELIMINARY TECHNICAL INFORMATION

HIGHLIGHTS

- Main power 230/400/480 V_{AC} / 50-60 Hz
- Ultra fast protection fuses included
- Multiple operating modes
- Multiple input levels
- Phase rotation protection
- LCD configuration / status indication
- LED indications of status
- Thermal protection with thermal switch
- Fault contact NC / NO



Non contractual image

GENERAL DESCRIPTION

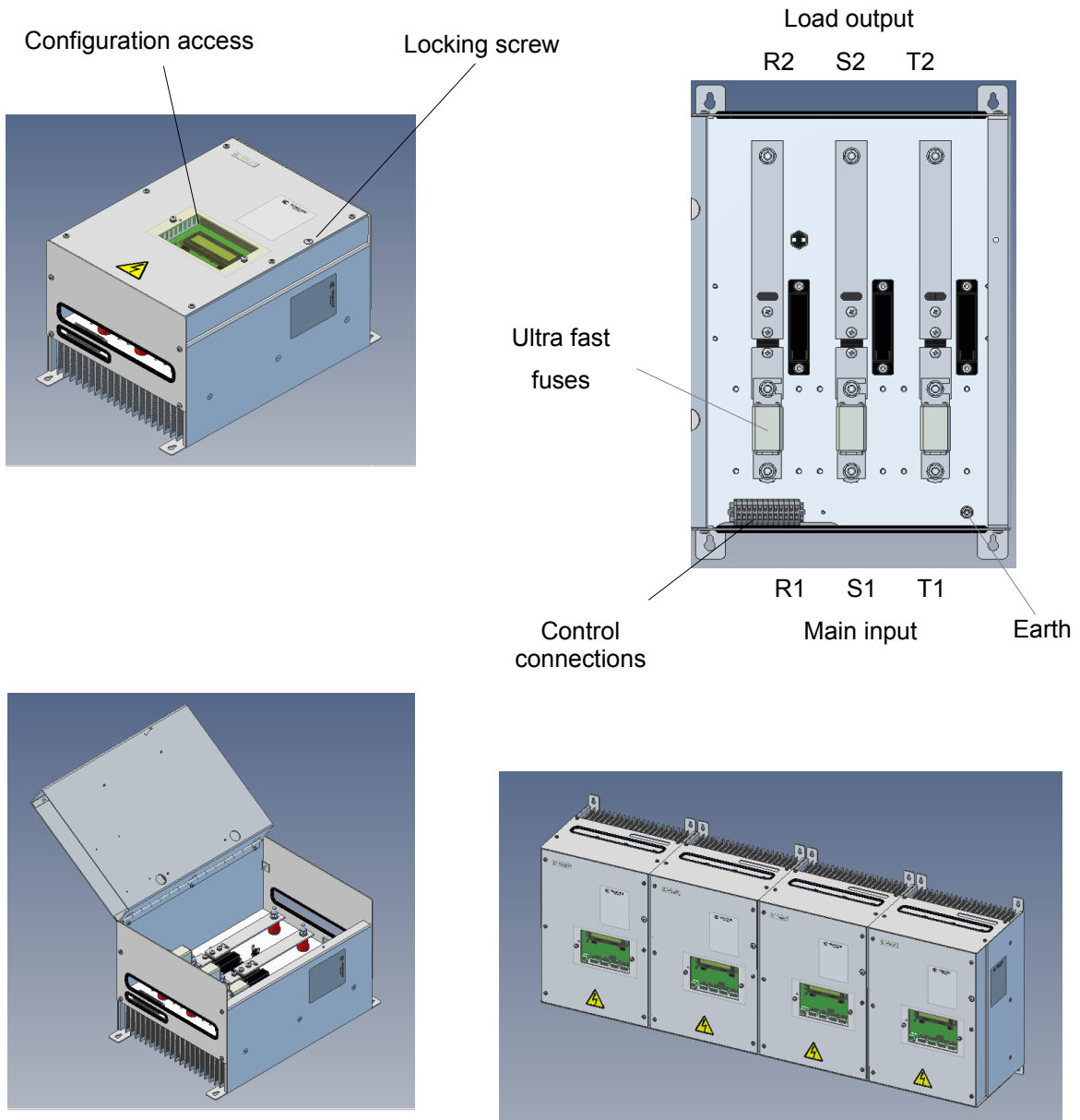

191205 Rev.:2

DIMENSIONS

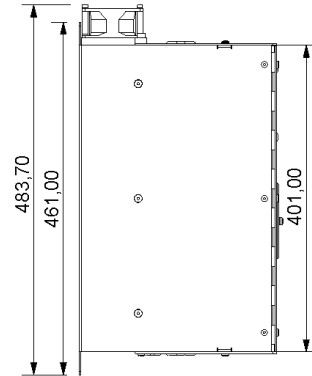
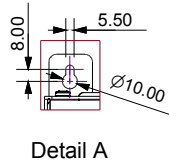
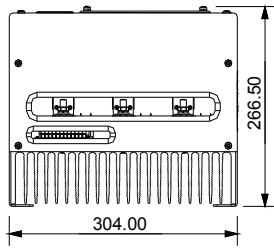

Forced convection versions

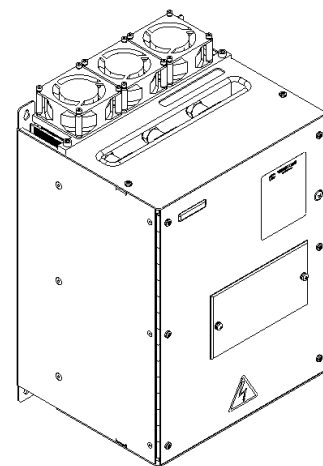
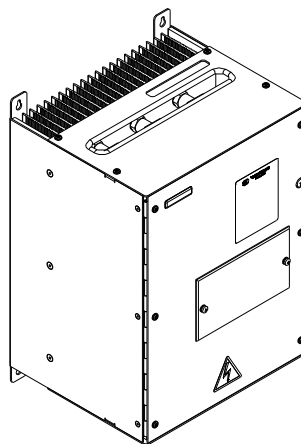
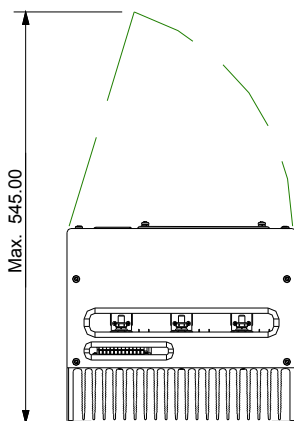
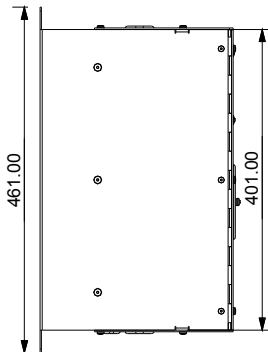
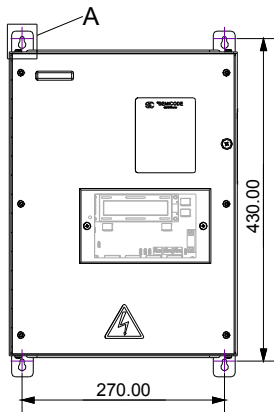

191205 Rev.:2

All dimensions in mm.

Reserves the right to change limits, test conditions and dimensions given in this data sheet at any time without previous notice.

RANGE AND CHARACTERISTICS

| Reference | Cooling | I _{OUT} Nom (A _{AC}) | Power (kW) | | |
|--------------------|---------|--|-------------------------------|----------------------------|----------------------------|
| | | | 230V _{AC} 50/60Hz | 400V _{AC} 50/60Hz | 480V _{AC} 50/60Hz |
| SC-ACR400/025kW-LA | Natural | 40 | 15 kW | 25 kW | 30 kW |
| SC-ACR400/050kW-LA | Natural | 75 | 30 kW | 50 kW | 60 kW |
| SC-ACR400/075kW-LA | Natural | 110 | 40 kW | 75 kW | 90 kW |
| SC-ACR400/100kW-LA | Natural | 150 | 60 kW | 100 kW | 120 kW |
| SC-ACR400/125kW-LA | Natural | 180 | 70 kW | 125 kW | 150 kW |
| SC-ACR400/180kW-LA | Forced | 260 | 100 kW | 185 kW | 215 kW |
| SC-ACR400/250kW-LA | Forced | 362 | 140 kW | 250 kW | 300 kW |

Characteristics at T_A = 40°C, 1000 m.a.s.l., full angle, working factor 100%

TERMINAL CONNECTIONS

| Power terminal | Type | Conditions |
|---------------------|------|----------------|
| Inputs R1, S1 y T1 | | |
| Outputs R2, S2 y T2 | M8 | Torque: 10 Nm. |
| Input fuses (1) | | |
| Earth connection | M6 | Torque: 4 Nm. |

(1) The function of the included fuses is the protection of the semiconductor against short circuits, the installation must provide the adequate protection of cables via line fuses and / or magnetothermic. In case of replacement, fuses of the same type as the one supplied must be used and the replace the 3 of them.

| Control terminal | Function | Conditions |
|------------------|---|--|
| 1 | Thermal protection jumper (NC contact) Option to connect external protections (external NC contacts) | |
| 2 | in series. | |
| 3 | Common/GND for external potentiometer / control signal (1) (2) | |
| 4 | Input external potentiometer / control signal input (1) (2) | |
| 5 | Positive output for external potentiometer (1) | |
| 6 | Control power (230 V _{AC} to 480 V _{AC} ; 50/60 Hz) | Snap in connection (without screws) Wire: 0.25-1 mm ² |
| 7 | | |
| 8 | NC fault signal output | |
| 9 | Common/GND fault signal output | |
| 10 | NO fault signal output | |
| 11 | External inhibition input (3) | |
| 12 | NO contact (normally open) | |

191205 Rev.:2

| | |
|--------|----------------------------|
| 13 (4) | Neutral point of fan power |
| 14 (4) | L1 phase fan power |
| 15 (4) | L2 phase fan power |
| 16 (4) | L3 phase fan power |

- (1) Regulation with potentiometer: Any type of 4k7 linear type potentiometer can be used.
- (2) Control signal: 0-5 V / 0-10 V / 0-20 mA configurable by DIP-switch; 4-20 mA configurable through LCD.
- (3) Signal of inhibition by external contact (by default NO, can be configured as NC).
- (4) Only on equipment with forced convection.

MOUNTING

- Mount the equipment in its location using 4 M5 screws.
- Several equipment can be mounted together laterally.
- You should leave a minimum ventilation space at the bottom and top 100 mm.

CONNECTION

- Open the top cover of the control to access the power section (by loosening the locking screw).
- Make the earth connection (M6 threaded stud).
- Connect the control cables, the included terminals work with pressure terminal (without screws).
- Connect the power inputs and outputs to ensure proper tightening.
- Close the top cover using the locking screw.

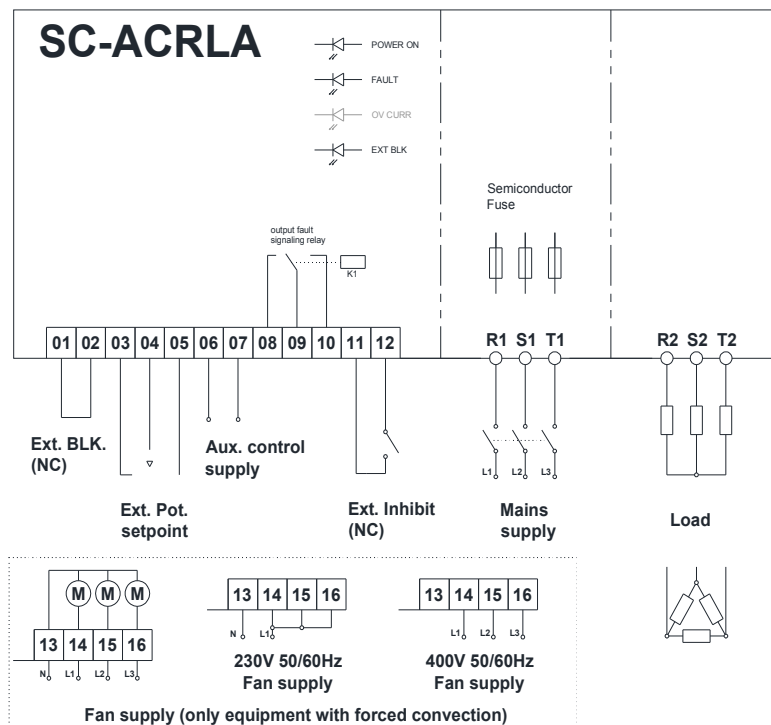

191205 Rev.:2

The default configuration of the device is as follows:

- Phase angle control (PSA, see "OPERATING MODES)
- 0-5 V reference signal / External potentiometer (4k7)
- Inhibit contact NC (normally closed)

OPERATING MODES

The control system allows to assign different operating modes according to the application to be performed:

- Phase Shift Angle mode (PSA)

In this operating mode, the phase of the sinus wave of the mains voltage is shifted. The shift depends on the setpoint value. In phase angle firing mode the controller conducts over a variable portion of the incoming AC cycle in response to the control input signal. Characteristic of this operating mode are the high control dynamics but when phase-shift angle control PS is used, harmonics of the mains voltage form.

The following image shows an example of PSA waveform according to the alpha setpoint going from 0 to 100% (full wave switch).

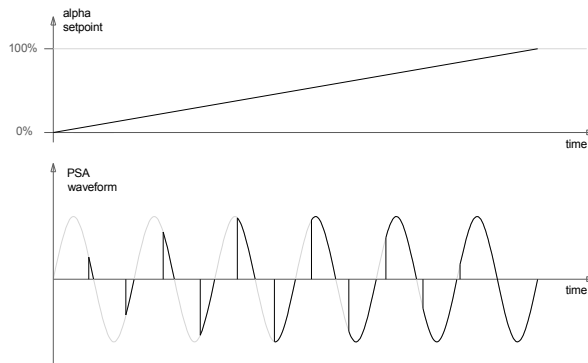

- Full Wave Switch mode (FWS)

In the FWS mode of operation, the mains voltage is periodically connected by generating packets or bursts of alternating current with respect to the setpoint signal. The grid periods are switched in integral multiples to avoid D.C component. The use of complete waves in FWS mode is particularly suitable for resistive loads with a high thermal inertia. The generation of disturbances in the network (harmonic and reactive) is minimal and the life of the resistors is extended.

This mode switches packets of 100 periods proportional to the setpoint.

The following figure shows an example of FWS waveform according to the setpoint. For the sake of simplicity, 5 wave packet periods are shown.

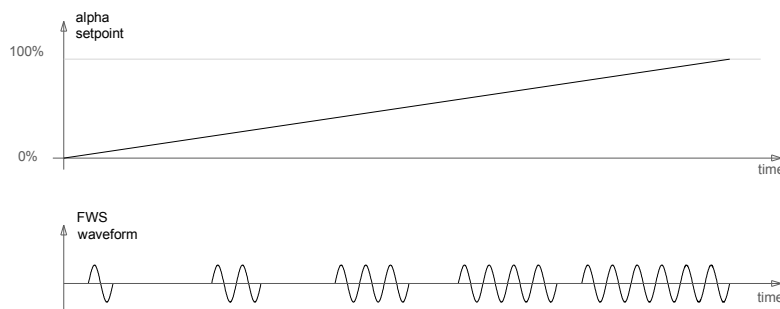

- Relay Mode (RLY)

The relay mode switches the outputs near the zero-cross voltage of the mains voltage. When a switching signal is applied to card's input control, the SCRs will switch when the voltage across its terminals crosses the 0 V. The switch off is produced naturally when the control signal is off and the direct current flowing through SCRs extinguishes.

In this mode the setpoint works as a digital trigger of the inputs (according to their configuration: TTL, 10 V, 20 mA).

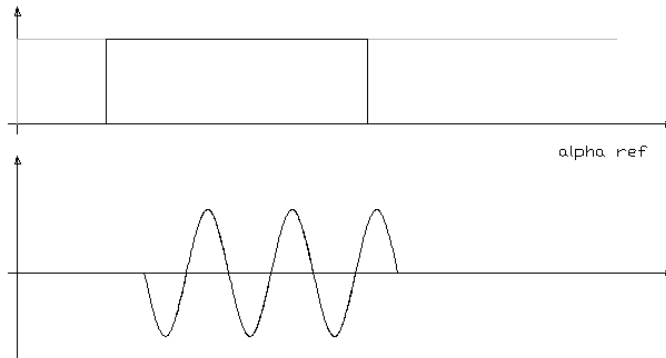

CONFIGURATION

With the exception of modifications or incidents, the configuration must only be carried out the first time (in the commissioning of the equipment).

To proceed, you must access the configuration keys on the control board by removing the transparent cover (by removing the corresponding screws):

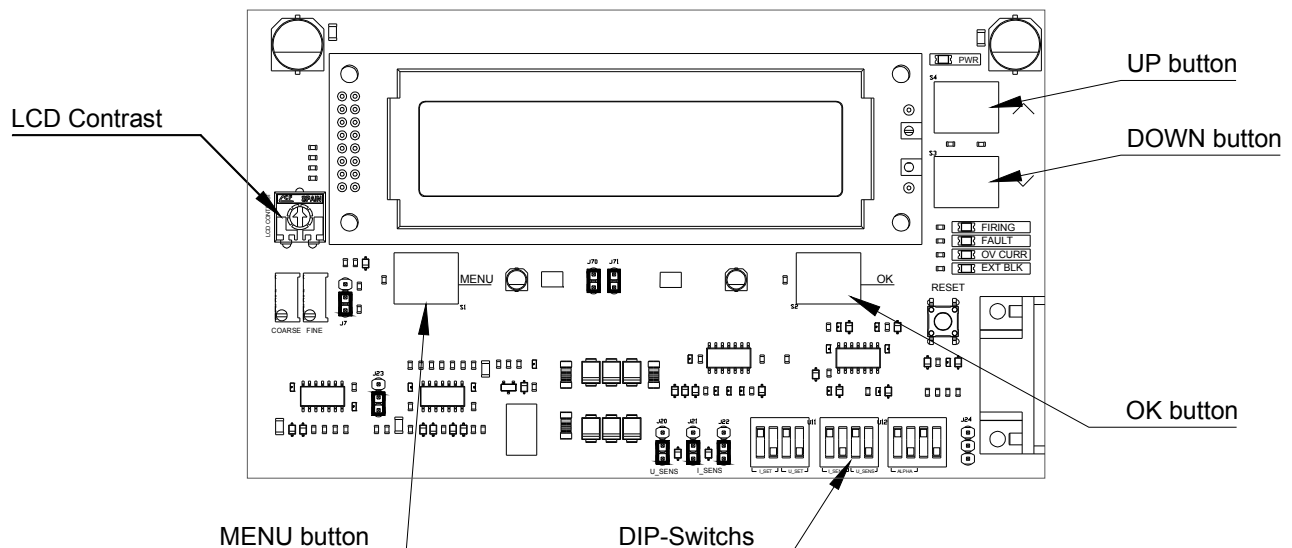

LCD screen indications (Main screen)

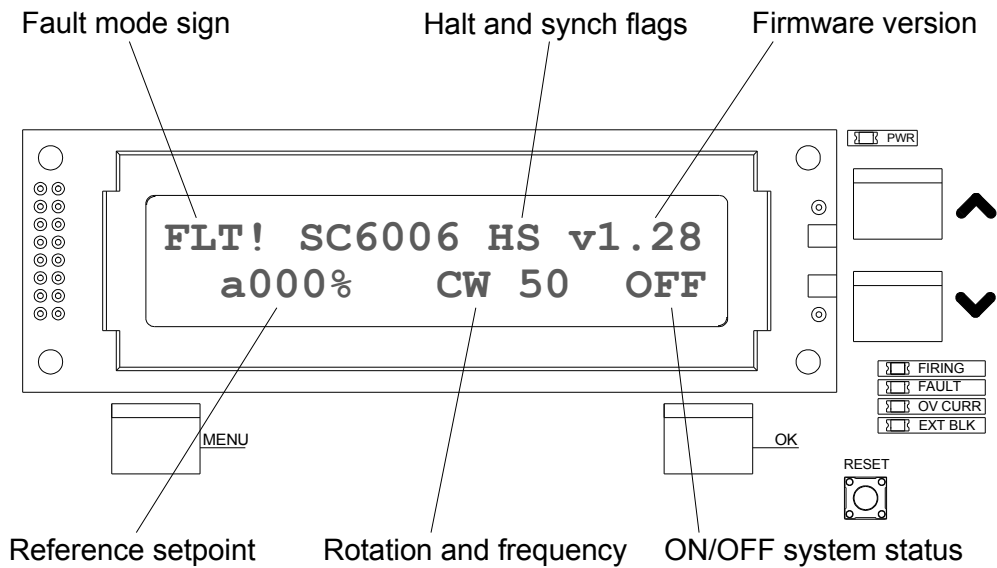

0-5 V / Pot reference input configuration. (Configuration supplied by default):

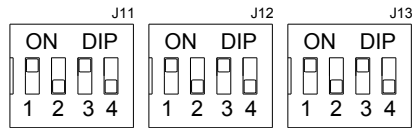

0-10 V reference input configuration:

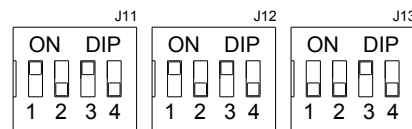

0-20 mA reference input configuration:

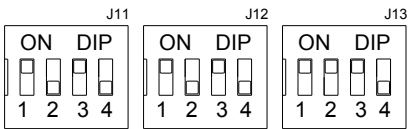

4-20 mA reference input configuration:

Starting from the 0-20 mA setting, activate the option via the LCD. The following is the sequence from the factory settings to change this configuration:

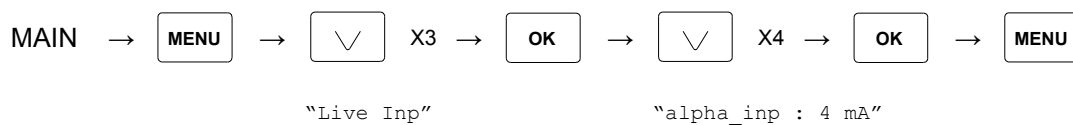

Setting Full Wave Switch mode of operation (FWS):

MAIN → MENU → ▽ → OK → MENU X2
 ">Mode : FWS"

Setting Relay mode of operation (RLY):

MAIN → MENU → ▽ → OK X2 → MENU X2
 ">Mode : RLY"

Start ramp settings (PSA and FWS modes only):

MAIN → MENU → ▽ X5 → OK X2 → MENU X3
 ">ON/OFF Ramps" ">Soft ON : ON"



Please note that the power ramp only works when the unit is operating in "PSA: phase shift angle" mode. For "RLY: Relay" mode, this setting does not affect its operation, while for "FWS: Full Wave Switch" mode, if the Soft ON mode is activated, the number of initial pulses can be set in which PSA is applied before reach the FWS pulse train.

Stop ramp setting (only for PSA and FWS modes):

MAIN → MENU → ▽ X5 → OK → ▽ X2 → OK → MENU X3
 ">ON/OFF Ramps" ">Soft OFF : ON"



Please note that the shutdown ramp only works when the unit is operating in "PSA: phase shift angle" mode. For "RLY: Relay" mode, this setting does not affect its operation, while for "FWS: Full Wave Switch" mode, if the Soft OFF mode is activated, the number of final pulses can be set in which PSA is applied before each the FWS pulse train.

Setting the inhibit signal to NC contact (normally closed):

MAIN → MENU → ▽ X6 → OK → ▽ → OK → MENU X3
 ">Faults" ">Inh : N.OFF"

Configuration for 60 Hz mains grid operation:

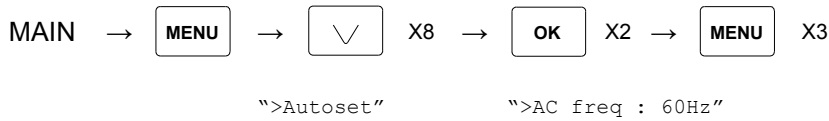

Saving a custom configuration (Save Settings):

Each time a configuration change is made via the LCD monitor of the controller, the user must save the changes in the EEPROM memory. When restarting the stack, the control card configuration will be the last one properly saved.

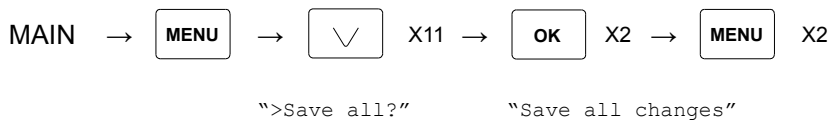

Restoring factory settings:

It is possible to return to the original factory settings and to delete the changes made in the configuration through the options menu on the LCD.



The control board will be reset to the original factory settings.

Remember also to check that the DIP-switches are in their original default configuration (5 V / Pot):

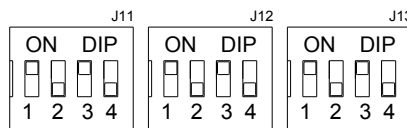

MAINTENANCE

An annual inspection of the following aspects is recommended:

- Check that there is no accumulation of dirt that prevents free cooling, if necessary clean the fins of the heatsink.
- Check correct tightening of the input / output terminals and the ground connection.

Cost Effective Products

SEMICODE ELECTRONICA

Offers to the market a comprehensive range of products from recognized manufacturers at the best price/quality ratio, this products are provided with a basic reference code that allows maintaining the same product reference even if the original device manufacturer is replaced. SEMICODE product reference has to be considered as a generic brand.

Seeking the market needs and trends, we are constantly increasing the product portfolio with new products and suppliers, please ask for the updated information available to our local contacts.

SEMICODE products include semiconductors, passive components and accessories focused in power electronics market.

Datasheet Annotations:

SEMICODE ELECTRONICA annotate datasheets in the top left hard corner of the front page, to indicate product status. The annotations are as follows:

Tentative information: This is the most tentative form of information and represents a very preliminary specification. No actual design work on the product has been started.

Preliminary Information: The product is in design and development. The datasheet represents the product as it is understood but details may change.

Advance Information: The product design is complete and final characterisation for volume production is well in hand.

No Annotation: The product parameters are fixed and the product is available to datasheet specification.

NOTICE: The technical data are to specify components, not to guarantee their properties. No warranty or guarantee expressed or implied is made regarding delivery or performance. The Company reserves the right to alter without prior notice the specification of any product. Information concerning possible methods of use is provided as a guide only and does not constitute any guarantee that such methods of use will be satisfactory in a specific piece of equipment. It is the user's responsibility to fully determine the performance and suitability of any equipment using such information and to ensure that any publication or data used is up to date.

All brand names and product names used in this publication are trademarks, registered trademarks or trade names of their respective owners.

© SEMICODE ELECTRONICA 2013. TECHNICAL DOCUMENTATION – NOT FOR RESALE