

	Page		Page
<b>General</b>		Studs: Rectifier & Avalanche Diodes & Thyristors	76
Contents	I	Rectifier Diode Modules	79, 139
Certified Management Systems	II	<b>Thyristors</b>	
Alphanumeric Index	III	Discretes Phase Control Thyristors	77
Symbols and Terms	XVIII	Thyristor / Diode Modules	81, 138
Nomenclature	XX	Thyristor Modules	84, 137
		Accessories & Design Information	88
<b>IXYS</b>		<b>Rectifier Bridges</b>	
<b>New Packages</b>	<b>0</b>	Rectifier Bridges with Fast Diodes	89
<b>ISOPLUS™ family</b>	<b>1</b>	1~ Rectifier Bridges	90
<b>ISOPLUS-SMPD™</b>	<b>2</b>	1~ Rectifier Bridges, half controlled	91
ISOPLUS-DIL™	7	3~ Rectifier Bridges	92
ISOPLUS i4-PAC™	8	3~ Rectifier Bridges with Brake Unit	94
		3~ Rectifier Bridges, half controlled	94
		AC Controller / Triac	96
		1~ / 3~ High Voltage Rectifiers	97
		Braking Rectifier Assemblies	97
<b>IGBT Discretes</b>	<b>11</b>	<b>Protection Devices</b>	
600V / 650V & 1200V XPT and NPT IGBTs	13	Break-over Diodes (BOD)	98
PT IGBTs, G-series, 3 <sup>rd</sup> and 4 <sup>th</sup> Generation	16	Fast Break-over Diodes (BOD)	99
<i>Fast PT IGBTs with SiC diode</i>	19	<b>IXYS ICD</b>	
High Voltage Types up to 4000 V	19	<b>Gate Drivers &amp; Power Relays</b>	
BiMOSFETs up to 3000 V	21	<b>101</b>	
		<b>IXYS UK</b>	
<b>IGBT Modules</b>	<b>22</b>	Application Notes & Technical Information	107
CBI Modules	22	Rectifier Diodes	108
Six-Packs	25	Fast Recovery Diodes	112
Multi Level, CBI and 6-Pack Solutions in <i>MiniPack2B</i> Housing	28	Soft Recovery Diodes	113
Multi Level, Half Bridge and Boost Modules in <i>SimBUS F</i> Housing	29	Extra Fast Recovery Diodes	116
6-Pack and Half Bridge High Power Modules	30	High Power Sonic FRD's	117
Full Bridge & Solar Inverter Modules	31	Phase Control Thyristors	118
Half Bridge and Buck / Boost Modules	32	Medium Voltage Thyristors	124
		Fast Turn-Off Thyristors	126
<b>Power MOSFETs</b>	<b>33</b>	Distributed Gate Thyristors	128
Trench MOSFETs / HiPerFETs (Fast Body Diode)	35	Asymmetric and Pulse Thyristors	133
TrenchT2™ MOSFETs / HiPerFETs (FBD)	38	GTOs	134
Polar™ MOSFETs / HiPerFETs (FBD)	41	Insulated Gate Bi-polar Transistors - <i>Press-Pack IGBTs</i>	135
PolarP2™ MOSFETs / HiPerFETs (FBD)	51	Press-Pack IGBT Gate Drive Units	136
PolarP3™ HiPerFETs (FBD)	51	Dual Thyristor /Single Thyristor Modules	137
Legacy (Standard) MOSFETs	53	Thyristor / Diode Modules	138
Extended FBSOA Linear Power MOSFETs	54	Dual & Single Diode Modules	139
Depletion-Mode MOSFETs	55	Water Cooled Diode & Thyristor Modules	140
PolarP™ & TrenchP™ P-channel MOSFETs	56	Power Semiconductor Assemblies	141
Q3-Class HiPerFET (FBD)	58	Westack - Modular Solutions	143
Very High Voltage MOSFETs (up to 4500 V)	59	WestackLITE - Modular Solutions	145
CoolMOS™	60	Power Semiconductor Accessories	147
Trench and MOSFET Modules	61	Bar Clamps / Box Clamps	148
<b>Power Factor Correction Modules</b>	<b>64</b>	Coolers / Heatsinks	152
		Snubber Capacitors	154
<b>Diodes</b>	<b>65</b>	<b>Power Semiconductor Chips @ DCB Ceramic Substrates</b>	
Schottky Gen <sup>2</sup> Diodes	66	<b>156</b>	
Schottky Diodes	68	<b>Outline Drawings</b>	
<i>Silicon Carbide Schottky Diodes</i>	69	IXYS UK	O-01
HiPerDyn™ FREDs & Dual Ultrafast Diodes	69	IXYS	O-30
HiPerFRED <sup>2</sup> ™ & HiPerFRED™ Diodes	70	<b>Application Notes Highlights</b>	
Sonic-FRDs™ Diodes	72	O-56	
FRED Diodes	73		
FRED & HiPerFRED™ Modules & Semifast Diodes	74		
Rectifier & Avalanche Types	75		

# Certified Management Systems

## Certificates



ISO 9001:2008

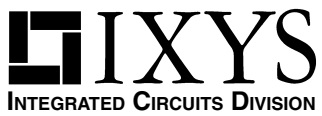

ISO 9001:2008



ISO/TS 16949:2009  
(includes ISO 9001:2008)  
ISO 14001:2009  
OHSAS 18001:2007



ISO 9001:2008





# Alphanumeric Index

- New
- Not for new design
- ✦ Under development

DSEI 2x61-02A	73	DSP 8-08S	75	<b>F</b>		IXBF 12N300	9, 21
DSEI 2x61-04C	73	DSP 8-12A	75	FBE 22-06N1	10, 89	IXBF 20N300	9, 21
DSEI 2x61-06C	73	DSP 8-12AC	75	FBO 16-12N	10, 64, 90	IXBF 32N300	9, 21
DSEI 2x61-06P	73	DSP 8-12AS	75	FBO 40-12N	10, 64, 90	IXBF 40N160	9, 21
DSEI 2x61-10B	73	DSP 8-12S	75	FBS 10-06SC	10, 69, 89	IXBF 42N300	9, 21
DSEI 2x61-12B	73	DSP 25-12A	75	FBS 10-12SC	10, 69, 89	IXBF 55N300	9, 21
DSEI 2x61-12P	73	DSP 25-12AT	75	FBS 16-06SC	10, 69, 89	IXBH 2N250	21
DSEI 2x101-06A	73	DSP 25-16A	75	FDM 15-06KC5	9, 60, 63	IXBH 5N160G	21
DSEI 2x101-06P	73	DSP 25-16AR	75	FDM 47-06KC5	9, 60, 63	IXBH 6N170	21
DSEI 2x101-12A	73	DSP 25-16AT	75	FID 60-06D	9, 64	IXBH 9N160G	21
DSEI 2x101-12P	73	DSP 45-12A	75	FII 30-06D	9	IXBH 10N170	21
DSEI 120-06A	73	➤ DSP 45-12AZ	75	FII 40-06D	9	IXBH 12N300	21
DSEI 120-12A	73	DSP 45-16A	75	FMD 15-06KC5	9, 60, 63, 64	IXBH 16N170	21
DSEI 2x121-02A	73	DSP 45-16AR	75	○ FMD 21-05QC	9, 63, 64	IXBH 16N170A	21
DSEI 2x161-02P	73	➤ DSP 45-16AZ	75	FMD 40-06KC	9, 60, 63, 64	IXBH 20N300	21
DSEI 2x161-06P	73	DSS 6-0025BS	68	FMD 47-06KC5	9, 60, 63, 64	IXBH 24N170	21
DSEI 2x161-12P	73	DSS 6-0045AS	68	➤ FMM 22-05PF	9, 62	IXBH 32N300	21
DSEK 60-02A	73	DSS 6-015AS	69	➤ FMM 22-06PF	9, 62	IXBH 40N160	21
DSEK 60-02AR	73	DSS 10-0045B	68	➤ FMM 50-025TF	9, 61	IXBH 42N170	21
DSEK 60-06A	73	DSS 10-006A	68	➤ FMM 60-02TF	9, 61	IXBH 42N170A	21
DSEK 60-12A	73	DSS 10-01A	68	FMM 75-01F	9, 62	IXBK 55N300	21
DSEP 6-06AS	71	DSS 10-01AS	68	FMM 150-0075X2F	9, 61	IXBK 64N250	21
DSEP 6-06BS	71	DSS 16-0045A	68	➤ FMP 26-02P	9, 62	IXBK 75N170	21
DSEP 8-06A	71	DSS 16-0045AS	68	➤ FMP 36-015P	9, 62	IXBK 75N170A	21
DSEP 8-06B	71	DSS 16-01A	68	➤ FMP 76-010T	9, 61	IXBL 64N250	21
DSEP 8-12A	71	DSS 16-01AS	68	FUE 30-12N1	10, 89	IXBN 42N170A	21
DSEP 12-12A	71	DSS 17-06CR	69	FUO 22-12N	10, 92	IXBN 75N170	21
➤ DSEP 12-12AZ	71	DSS 20-0015B	68	FUO 22-16N	10, 92	IXBN 75N170A	21
DSEP 12-12B	71	DSS 20-01AC	68	FUO 50-16N	10, 92	IXBOD 1-06	98
➤ DSEP 12-12BZ	71	DSS 25-0025B	68	FUS 45-0045B	10, 68, 89	IXBOD 1-07	98
DSEP 15-06A	71	DSS 25-0045A	68	<b>G</b>		IXBOD 1-08	98
➤ DSEP 15-06AS	71	DSS 40-0008D	68	GBO 25-12NO1	90	IXBOD 1-09	98
DSEP 15-06B	71	DSS 2x41-01A	68	GBO 25-16NO1	90	IXBOD 1-10	98
➤ DSEP 15-06BS	71	DSS 60-0045B	68	GMM 3x60-015X2	7, 61	IXBOD 1-12R	98
DSEP 15-12CR	69	DSS 2x61-0045A	68	GUO 40-08NO1	92	IXBOD 1-12RD	98
DSEP 2x25-12C	69	DSS 2x61-01A	68	GUO 40-12NO1	92	IXBOD 1-13R	98
DSEP 29-06A	71	DSS 2x81-0045B	68	GUO 40-16NO1	92	IXBOD 1-13RD	98
DSEP 29-06AS	71	DSS 2x101-015A	69	<b>I</b>		IXBOD 1-14R	98
DSEP 29-06B	71	DSS 2x101-02A	69	IX2127	104	IXBOD 1-14RD	98
DSEP 29-12A	71	DSS 2x111-008A	68	➤ IX3120	104	IXBOD 1-15R	98
DSEP 30-06A	71	DSS 2x121-0045B	68	IX4423	103	IXBOD 1-15RD	98
DSEP 30-06B	71	DSS 2x160-0045A	68	IX4424	103	IXBOD 1-16R	98
DSEP 30-06BR	71	DSS 2x160-01A	68	IX4425	103	IXBOD 1-16RD	98
DSEP 30-12A	71	DSS 2x200-0008D	68	IX4426	103	IXBOD 1-17R	98
DSEP 30-12AR	71	DSSK 10-018A	69	IX4427	103	IXBOD 1-17RD	98
DSEP 30-12CR	69	DSSK 16-01A	68	IX4428	103	IXBOD 1-18R	98
DSEP 2x31-03A	71	DSSK 16-01AS	68	➤ IXA 4IF1200TZ	0, 15	IXBOD 1-18RD	98
DSEP 2x31-06A	71	DSSK 18-0025BS	68	IXA 4IF1200UC	15	IXBOD 1-19R	98
DSEP 2x31-06B	71	DSSK 20-0045B	68	IXA 12IF1200HB	15	IXBOD 1-19RD	98
DSEP 2x31-12A	71	DSSK 20-015A	69	IXA 12IF1200PB	15	IXBOD 1-20R	98
DSEP 40-03AS	71	DSSK 28-0045BS	68	➤ IXA 12IF1200PZ	0, 15	IXBOD 1-20RD	98
DSEP 60-06A	71	DSSK 28-006BS	68	IXA 12IF1200TC	15	IXBOD 1-21R	98
DSEP 60-06AT	71	DSSK 28-01AS	68	IXA 17IF1200HJ	15	IXBOD 1-21RD	98
DSEP 60-12A	71	DSSK 30-01A	68	IXA 20I1200PB	15	IXBOD 1-22R	98
DSEP 2x60-12A	71	DSSK 30-018A	69	➤ IXA 20I1200PZ	0, 15	IXBOD 1-22RD	98
DSEP 60-12AR	71	DSSK 38-0025B	68	IXA 20IF1200HB	15	IXBOD 1-23R	98
DSEP 2x61-03A	71	DSSK 38-0025BS	68	IXA 20PG1200DHGLB	5	IXBOD 1-23RD	98
DSEP 2x61-06A	71	DSSK 40-0015B	68	➤ IXA 20PT1200LB	5	IXBOD 1-24R	98
DSEP 2x61-12A	71	DSSK 40-006B	68	IXA 20RG1200DHGLB	5	IXBOD 1-24RD	98
DSEP 2x91-03A	71	DSSK 40-008B	68	IXA 27IF1200HJ	15	IXBOD 1-25R	98
DSEP 2x91-06A	71	DSSK 48-0025B	68	➤ IXA 30PG1200DHGLB	5	IXBOD 1-25RD	98
DSEP 2x101-04A	71	DSSK 48-003B	68	➤ IXA 30RG1200DHGLB	5	IXBOD 1-26R	98
DSI 17-08A	76	DSSK 48-003BS	68	IXA 33IF1200HB	15	IXBOD 1-26RD	98
DSI 17-12A	76	DSSK 50-0025B	68	➤ IXA 35PF650LB	5	IXBOD 1-28R	98
DSI 30-08A	75	DSSK 50-01A	68	IXA 37IF1200HJ	15	IXBOD 1-28RD	98
DSI 30-08AC	75	DSSK 50-015A	69	➤ IXA 40I4000KN	20	IXBOD 1-30R	98
DSI 30-08AS	75	DSSK 60-0045A	68	IXA 40PG1200DHGLB	5	IXBOD 1-30RD	98
DSI 30-12A	75	DSSK 60-0045B	68	IXA 40RG1200DHGLB	5	IXBOD 1-32R	98
DSI 30-12AS	75	DSSK 60-015A	69	IXA 45IF1200HB	15	IXBOD 1-32RD	98
DSI 30-16A	75	DSSK 60-015AR	69	IXA 55I1200HJ	15	IXBOD 1-34R	98
DSI 30-16AS	75	DSSK 60-02A	69	➤ IXA 55PF650LB	5	IXBOD 1-36R	98
DSI 35-08A	76	DSSK 60-02AR	69	✦ IXA 60IF1200DHGLB	5	IXBOD 1-38R	98
DSI 35-12A	76	DSSK 70-0015B	68	IXA 60IF1200NA	15	IXBOD 1-40R	98
DSI 45-08A	75	DSSK 70-003B	68	IXA 70I1200NA	15	IXBOD 1-42R	98
DSI 45-12A	75	DSSK 70-008A	68	➤ IXA 70R1200NA	15	IXBOD 2-01	99
DSI 45-16A	75	DSSK 70-008AR	68	➤ IXA 80PF650LB	5	IXBOD 2-02	99
DSI 45-16AR	75	DSSK 80-0008D	68	✦ IXA 85IF1200DHGLB	5	IXBOD 2-03	99
DSI 2x55-12A	75	DSSK 80-0025B	68	✦ IXA 90IF650NA	15	IXBOD 2-04	99
DSI 2x55-16A	75	DSSK 80-003B	68	✦ IXA 110XF650ALB	5	IXBOD 2-05	99
DSI 75-08B	76	DSSK 80-0045B	68	✦ IXA 220I650NA	15	IXBOD 2-06	99
DSI 75-12B	76	DSSK 80-006B	68	✦ IXB 80IF600NA	15	IXBOD 2-07	99
DSIK 45-16AR	75	DSSK 80-006BR	68	✦ IXB 200I600NA	15	IXBOD 2-08	99
DSP 8-08A	75	DSSS 30-01AR	68	➤ IXBA 12N300HV	0, 21	IXBOD 2-09	99
DSP 8-08AS	75	DSSS 35-008AR	68	IXBF 9N160G	9, 21	IXBOD 2-10	99

# Alphanumeric Index

- > New
- Not for new design
- ◇ Under development

IXBOD 2-11	99	> IXBT 20N300HV	0, 21	IXFB 300N10P	45	IXFH 140N10P	45
IXBOD 2-12	99	IXBT 24N170	21	IXFC 10N80P	47	IXFH 150N15P	45
IXBOD 2-13	99	IXBT 32N300	21	IXFC 12N80P	47	IXFH 150N17T2	40
IXBOD 2-14	99	IXBT 42N170	21	IXFC 14N60P	47	IXFH 150N20T	37
IXBOD 2-15R	99	IXBT 42N170A	21	IXFC 14N80P	48	IXFH 160N15T	37
IXBOD 2-15RD	99	> IXBT 42N300HV	0, 21	IXFC 16N50P	46	IXFH 160N15T2	40
IXBOD 2-16R	99	IBX 25N250	21	IXFC 16N80P	48	IXFH 170N10P	45
IXBOD 2-16RD	99	IBX 55N300	21	IXFC 20N80P	48	IXFH 230N075T2	40
IXBOD 2-17R	99	IBX 64N250	21	IXFC 22N60P	47	IXFH 230N10T	37
IXBOD 2-17RD	99	IBX 75N170	21	IXFC 26N50P	46	IXFH 320N10T2	40
IXBOD 2-18R	99	IBX 75N170A	21	IXFC 30N60P	47	IXFH 340N075T2	40
IXBOD 2-18RD	99	IXCH 36N250	21	IXFC 36N50P	46	IXFH 400N075T2	40
IXBOD 2-19R	99	IXCK 36N250	21	IXFC 52N30P	45	IXFK 20N120P	50
IXBOD 2-19RD	99	IXD_602	103	IXFC 74N20P	45	IXFK 24N80P	48
IXBOD 2-20R	99	IXD_604	103	IXFC 96N15P	45	IXFK 24N100Q3	58
IXBOD 2-20RD	99	IXD_609	103	IXFC 110N10P	45	IXFK 26N100P	49
IXBOD 2-21R	99	IXD_614	103	IXFH 5N100P	49	IXFK 26N120P	50
IXBOD 2-21RD	99	IXD_630	103	IXFH 6N120P	49	IXFK 32N80P	48
IXBOD 2-22R	99	IXD_630M	103	IXFH 7N100P	49	IXFK 32N80Q3	58
IXBOD 2-22RD	99	◇ IXD 75IF650NA	15	IXFH 10N80P	48	IXFK 32N90P	48
IXBOD 2-23R	99	◇ IXD 80IF650LB	5	IXFH 10N100P	49	IXFK 32N100P	49
IXBOD 2-23RD	99	◇ IXD 110IF650LB	5	IXFH 12N80P	48	IXFK 32N100Q3	58
IXBOD 2-24R	99	IXDA 20N120AS	15	IXFH 12N90P	48	IXFK 36N60P	47
IXBOD 2-24RD	99	IXDH 20N120	15	IXFH 12N100P	49	IXFK 40N90P	49
IXBOD 2-25R	99	IXDH 20N120D1	15	IXFH 12N120P	49	IXFK 44N50P	46
IXBOD 2-25RD	99	○ IXDH 30N120	15	IXFH 14N60P	47	IXFK 44N80P	48
IXBOD 2-26R	99	○ IXDH 30N120D1	15	IXFH 14N60P3	52	IXFK 44N80Q3	58
IXBOD 2-26RD	99	○ IXDH 35N60B	15	IXFH 14N80P	48	IXFK 48N60P	47
IXBOD 2-27R	99	IXDH 35N60BD1	15	IXFH 15N100P	49	IXFK 48N60Q3	58
IXBOD 2-27RD	99	IXDN 55N120D1	15	IXFH 15N100Q3	58	IXFK 64N50P	46
IXBOD 2-28R	99	IXDN 75N120	15	IXFH 16N50P	46	IXFK 64N50Q3	58
IXBOD 2-28RD	99	IXDP 20N60B	15	IXFH 16N50P3	51	IXFK 64N60P	47
IXBOD 2-29R	100	IXDP 20N60BD1	15	IXFH 16N60P3	52	IXFK 64N60Q3	52
IXBOD 2-29RD	100	○ IXDP 35N60B	15	IXFH 16N80P	48	IXFK 64N60Q3	58
IXBOD 2-30R	100	○ IXDR 30N120	15	IXFH 16N120P	49	IXFK 74N50P2	51
IXBOD 2-30RD	100	○ IXDR 30N120D1	15	IXFH 18N60P	47	IXFK 78N50P3	52
IXBOD 2-31R	100	○ IXDR 35N60BD1	15	IXFH 18N90P	48	IXFK 80N50P	47
IXBOD 2-31RD	100	◇ IXE 50PF600LB	5	IXFH 18N100Q3	58	IXFK 80N50Q3	58
IXBOD 2-32R	100	IXEL 40N400	20	IXFH 20N50P3	52	IXFK 80N60P3	52
IXBOD 2-32RD	100	IXFA 4N60P3	52	IXFH 20N80P	48	IXFK 88N30P	46
IXBOD 2-33R	100	IXFA 4N100P	49	IXFH 20N100P	49	IXFK 94N50P2	51
IXBOD 2-33RD	100	IXFA 5N50P3	51	IXFH 22N50P	46	IXFK 98N50P3	52
IXBOD 2-34R	100	IXFA 5N100P	49	IXFH 22N60P	47	IXFK 102N30P	46
IXBOD 2-34RD	100	IXFA 6N120P	49	IXFH 22N60P3	52	IXFK 120N20P	45
IXBOD 2-35R	100	IXFA 7N60P3	52	IXFH 24N80P	48	IXFK 120N25P	45
IXBOD 2-35RD	100	IXFA 7N80P	47	IXFH 24N90P	48	IXFK 120N30P3	51
IXBOD 2-36R	100	IXFA 7N100P	49	IXFH 26N50P	46	IXFK 120N30T	37
IXBOD 2-36RD	100	IXFA 8N50P3	51	IXFH 26N50P3	52	IXFK 140N20P	45
IXBOD 2-37R	100	IXFA 10N60P	47	IXFH 26N60P	47	IXFK 140N25T	37
IXBOD 2-37RD	100	IXFA 10N80P	48	IXFH 28N60P3	52	IXFK 140N30P	46
IXBOD 2-38R	100	IXFA 12N50P	46	IXFH 30N50P	46	IXFK 150N15P	45
IXBOD 2-38RD	100	IXFA 14N60P	47	IXFH 30N50Q3	58	IXFK 150N30P3	51
IXBOD 2-39R	100	IXFA 14N60P3	52	IXFH 30N60P	47	IXFK 160N30T	37
IXBOD 2-39RD	100	IXFA 16N50P	46	IXFH 34N50P3	52	IXFK 170N10P	45
IXBOD 2-40R	100	IXFA 16N50P3	51	IXFH 36N50P	46	IXFK 170N20P	45
IXBOD 2-40RD	100	IXFA 16N60P3	52	IXFH 36N60P	47	IXFK 170N20T	37
IXBOD 2-41R	100	IXFA 20N50P3	52	IXFH 42N50P2	51	IXFK 180N15P	45
IXBOD 2-41RD	100	IXFA 22N60P3	52	IXFH 42N60P3	52	IXFK 180N25T	37
IXBOD 2-42R	100	IXFA 26N50P3	52	IXFH 44N50P	46	IXFK 200N10P	45
IXBOD 2-42RD	100	IXFA 76N15T2	40	IXFH 44N50Q3	58	IXFK 220N15P	45
IXBOD 2-43R	100	IXFA 102N15T	37	IXFH 50N30Q3	58	IXFK 220N17T2	40
IXBOD 2-44R	100	IXFA 110N15T2	40	IXFH 50N50P3	52	IXFK 230N20T	37
IXBOD 2-45R	100	IXFA 130N10T	37	IXFH 50N60P3	52	IXFK 240N15T2	40
IXBOD 2-46R	100	IXFA 130N10T2	40	IXFH 52N30P	45	IXFK 250N10P	45
IXBOD 2-47R	100	IXFA 180N10T2	40	IXFH 52N50P2	51	IXFK 320N17T2	40
IXBOD 2-48R	100	IXFA 230N075T2	40	IXFH 60N50P3	52	IXFK 360N10T	37
IXBOD 2-49R	100	IXFA 230N075T2-7	40	IXFH 69N30P	45	IXFK 360N15T2	40
IXBOD 2-50R	100	IXFB 30N120P	50	IXFH 70N20Q3	58	IXFK 420N10T	37
IXBOD 2-51R	100	IXFB 40N110P	49	IXFH 70N30Q3	58	IXFK 520N075T2	40
IXBOD 2-52R	100	IXFB 44N100P	49	IXFH 74N20P	45	IXFL 30N120P	50
IXBOD 2-53R	100	IXFB 44N100Q3	58	IXFH 86N30T	37	IXFL 32N120P	50
IXBOD 2-54R	100	IXFB 52N90P	49	IXFH 88N30P	46	IXFL 36N110P	49
IXBOD 2-55R	100	IXFB 60N80P	48	IXFH 94N30P3	51	IXFL 38N100P	49
IXBOD 2-56R	100	IXFB 62N80Q3	58	IXFH 94N30T	37	IXFL 40N110P	49
IXBP 5N160G	21	IXFB 82N60P	47	IXFH 96N15P	45	IXFL 44N100P	49
IXBR 42N170	21	IXFB 82N60Q3	58	IXFH 96N20P	45	IXFL 60N80P	48
IXBT 2N250	21	IXFB 100N50P	47	IXFH 100N25P	45	IXFL 82N60P	47
IXBT 6N170	21	IXFB 100N50Q3	58	IXFH 102N15T	37	IXFL 100N50P	47
IXBT 10N170	21	IXFB 110N60P3	52	IXFH 110N10P	45	IXFL 132N50P3	52
IXBT 12N300	21	IXFB 120N50P2	51	IXFH 110N15T2	40	IXFL 210N30P3	51
> IXBT 12N300HV	0, 21	IXFB 132N50P3	52	IXFH 110N25T	37	IXFN 20N120P	50
IXBT 16N170	21	IXFB 170N30P	46	IXFH 120N15P	45	IXFN 26N100P	49
IXBT 16N170A	21	IXFB 210N20P	45	IXFH 120N20P	45	IXFN 26N120P	50
IXBT 20N300	21	IXFB 210N30P3	51	IXFH 120N25T	37	IXFN 30N120P	50

# Alphanumeric Index

- New
- Not for new design
- ◆ Under development

IXFN 32N80P	48	IXFQ 22N60P3	52	IXFT 340N075T2	40	IXGA 30N60C3D4	16
IXFN 32N100P	49	IXFQ 24N50P2	51	IXFT 400N075T2	40	IXGA 30N120B3	18
IXFN 32N100Q3	58	IXFQ 26N50P3	52	IXFV 10N100P	49	IXGA 36N60A3	17
IXFN 32N120P	50	IXFQ 28N60P3	52	IXFV 12N80P	48	IXGA 42N30C3	16
IXFN 38N100P	49	IXFQ 34N50P3	52	IXFV 12N90P	48	IXGA 48N60A3	17
IXFN 40N90P	49	IXFQ 50N50P3	52	IXFV 12N100P	49	IXGA 48N60B3	17
IXFN 40N110P	49	IXFQ 50N60P3	52	IXFV 12N120P	49	IXGA 48N60C3	16
IXFN 44N80P	48	IXFQ 60N50P3	52	IXFV 14N80P	48	IXGA 50N60B4	18
IXFN 44N80Q3	58	IXFQ 94N30P3	51	IXFV 15N100P	49	IXGA 50N60C4	18
IXFN 44N100P	49	IXFR 15N100Q3	58	IXFV 16N80P	48	IXGB 200N60B3	16
IXFN 44N100Q3	58	IXFR 16N120P	49	IXFV 18N60P	47	IXGF 20N250	9, 20
IXFN 48N60P	47	IXFR 18N90P	48	IXFV 18N90P	48	IXGF 20N300	9, 20
IXFN 52N90P	49	IXFR 20N80P	48	IXFV 20N80P	48	IXGF 25N250	9, 20
IXFN 56N90P	49	IXFR 20N100P	49	IXFV 22N50P	46	IXGF 25N300	9, 20
IXFN 60N80P	48	IXFR 20N120P	49	IXFV 22N60P	47	IXGF 30N400	9, 20
IXFN 62N80Q3	58	IXFR 24N80P	48	IXFV 26N50P	46	IXGF 32N170	9, 19
IXFN 64N50P	46	IXFR 24N90P	48	IXFV 26N60P	47	IXGF 36N300	9, 20
IXFN 64N60P	47	IXFR 24N100Q3	58	IXFV 30N50P	46	IXGH 2N250	20
IXFN 80N50P	46	IXFR 26N100P	49	IXFV 30N60P	47	IXGH 4N250C	20
IXFN 80N50Q3	58	IXFR 26N120P	49	IXFV 36N50P	46	IXGH 6N170	19
IXFN 82N60P	47	IXFR 30N60P	47	IXFV 52N30P	45	IXGH 6N170A	20
IXFN 82N60Q3	58	IXFR 32N80P	48	IXFV 74N20P	45	IXGH 10N170	19
IXFN 100N50P	47	IXFR 32N80Q3	58	IXFV 96N15P	45	IXGH 10N170A	20
IXFN 100N50Q3	58	IXFR 32N100P	49	IXFV 96N20P	45	IXGH 10N300	20
IXFN 102N30P	46	IXFR 32N100Q3	58	IXFV 110N10P	45	IXGH 12N120A3	18
IXFN 110N60P3	52	IXFR 36N50P	46	IXFV 110N25T	37	IXGH 16N170	19
IXFN 132N50P3	52	IXFR 36N60P	47	IXFX 20N120P	50	IXGH 16N170A	20
IXFN 140N20P	45	IXFR 40N90P	48	IXFX 24N100Q3	58	IXGH 16N170AH1	20
IXFN 140N25T	37	IXFR 44N50P	46	IXFX 26N100P	49	IXGH 20N120A3	18
IXFN 140N30P	46	IXFR 44N50Q3	58	IXFX 26N120P	50	IXGH 24N60C4	18
IXFN 160N30T	37	IXFR 44N80P	48	IXFX 32N80P	48	IXGH 24N60C4D1	18
IXFN 170N30P	46	IXFR 48N60P	47	IXFX 32N80Q3	58	IXGH 24N170	19
IXFN 180N15P	45	IXFR 48N60Q3	58	IXFX 32N90P	49	IXGH 24N170A	20
IXFN 180N25T	37	IXFR 64N50P	46	IXFX 32N100P	49	IXGH 24N170AH1	20
IXFN 200N10P	45	IXFR 64N50Q3	58	IXFX 32N100Q3	58	IXGH 25N160	19
IXFN 210N20P	45	IXFR 64N60P	47	IXFX 40N90P	49	IXGH 25N250	20
IXFN 210N30P3	51	IXFR 64N60Q3	58	IXFX 44N80P	48	IXGH 28N60B3D1	16
IXFN 230N20T	37	IXFR 80N50P	46	IXFX 44N80Q3	58	IXGH 30N60B4	18
IXFN 240N15T2	40	IXFR 80N50Q3	58	IXFX 48N60P	47	IXGH 30N60C3	16
IXFN 300N10P	45	IXFR 80N60P3	52	IXFX 48N60Q3	58	➤ IXGH 30N60C3C1	19
IXFN 320N17T2	40	IXFR 102N30P	45	IXFX 64N50P	46	IXGH 30N60C3D1	16
IXFN 360N10T	37	IXFR 140N20P	45	IXFX 64N50Q3	58	IXGH 30N120B3	18
IXFN 360N15T2	40	IXFR 140N30P	46	IXFX 64N60P	47	IXGH 30N120B3D1	18
IXFN 420N10T	37	IXFR 180N15P	45	IXFX 64N60P3	52	IXGH 32N100A3	18
IXFN 520N075T2	40	IXFR 200N10P	45	IXFX 64N60Q3	58	IXGH 32N120A3	18
IXFP 3N50PM	46	IXFR 230N20T	37	IXFX 74N50P2	51	IXGH 32N170	19
IXFP 4N60P3	52	IXFT 14N80P	48	IXFX 78N50P3	52	IXGH 32N170A	20
IXFP 4N100P	49	IXFT 15N100Q3	58	IXFX 80N50P	47	IXGH 36N60A3	17
IXFP 4N100PM	49	IXFT 16N80P	48	IXFX 80N50Q3	58	IXGH 36N60A3D4	16
IXFP 5N50P3	51	IXFT 16N120P	50	IXFX 80N60P3	52	IXGH 36N60B3	17
IXFP 5N50PM	46	IXFT 18N90P	48	IXFX 94N50P2	51	➤ IXGH 36N60B3C1	19
IXFP 05N100M	49	IXFT 18N100Q3	58	IXFX 98N50P3	52	IXGH 36N60B3D1	17
IXFP 5N100P	49	IXFT 20N80P	48	IXFX 120N25P	45	IXGH 36N60B3D4	17
IXFP 6N120P	49	IXFT 20N100P	49	IXFX 120N30P3	51	IXGH 42N30C3	16
IXFP 7N60P3	52	IXFT 24N80P	48	IXFX 120N30T	37	IXGH 48N60A3	17
IXFP 7N80P	47	IXFT 24N90P	48	IXFX 140N25T	37	IXGH 48N60A3D1	16
IXFP 7N80PM	47	IXFT 26N60P	47	IXFX 140N30P	46	IXGH 48N60B3	17
IXFP 7N100P	49	IXFT 30N50P	46	IXFX 150N30P3	51	➤ IXGH 48N60B3C1	19
IXFP 8N50P3	51	IXFT 30N50Q3	58	IXFX 160N30T	37	IXGH 48N60B3D1	17
IXFP 8N50PM	46	IXFT 30N60P	47	IXFX 170N20P	45	IXGH 48N60C3	16
IXFP 10N60P	47	IXFT 36N50P	46	IXFX 170N20T	37	➤ IXGH 48N60C3C1	19
IXFP 10N80P	48	IXFT 36N60P	47	IXFX 180N15P	45	IXGH 48N60C3D1	16
IXFP 12N50P	46	IXFT 42N50P2	51	IXFX 180N25T	37	IXGH 50N60B4	18
IXFP 12N50PM	46	IXFT 44N50P	46	IXFX 200N10P	45	IXGH 50N60B4D1	18
IXFP 14N60P	47	IXFT 44N50Q3	58	IXFX 220N15P	45	IXGH 50N60C4	18
IXFP 14N60P3	52	IXFT 50N30Q3	58	IXFX 220N17T2	40	IXGH 50N60C4D1	18
IXFP 16N50P	46	IXFT 50N50P3	52	IXFX 230N20T	37	IXGH 56N60A3	17
IXFP 16N50P3	52	IXFT 50N60P3	52	IXFX 240N15T2	40	IXGH 56N60B3	17
IXFP 16N60P3	52	IXFT 52N50P2	51	IXFX 250N10P	45	IXGH 56N60B3D1	17
IXFP 20N50P3	52	IXFT 60N50P3	52	IXFX 320N17T2	40	IXGH 60N30C3	16
IXFP 20N50P3M	51	IXFT 69N30P	45	IXFX 360N10T	37	IXGH 60N60C3	16
IXFP 22N60P3	52	IXFT 70N20Q3	58	IXFX 360N15T2	40	IXGH 60N60C3D1	16
IXFP 26N50P3	52	IXFT 70N30Q3	58	IXFX 420N10T	37	IXGH 64N60A3	17
IXFP 76N15T2	40	IXFT 86N30T	37	IXFX 520N075T2	40	IXGH 64N60B3	17
IXFP 102N15T	37	IXFT 88N30P	46	IXFY 4N60P3	52	IXGH 72N60A3	16
IXFP 110N15T2	40	IXFT 94N30P3	51	IXFY 5N50P3	51	IXGH 72N60B3	16
IXFP 130N10T	37	IXFT 94N30T	37	IXFZ 140N25T	37	IXGH 72N60C3	16
IXFP 130N10T2	40	IXFT 96N20P	45	IXFZ 520N075T2	40	IXGH 85N30C3	16
IXFP 180N10T2	40	IXFT 120N15P	45	IXGA 12N120A3	18	IXGH 90N60B3	16
IXFP 230N075T2	40	IXFT 120N25T	37	IXGA 20N120A3	18	IXGH 100N30B3	16
IXFQ 10N80P	48	IXFT 140N10P	45	IXGA 20N120B3	18	IXGH 100N30C3	16
IXFQ 12N80P	48	IXFT 150N17T2	40	➤ IXGA 20N250HV	0, 20	IXGH 120N30B3	16
IXFQ 14N80P	48	IXFT 150N20T	37	IXGA 30N60C3	16	IXGH 120N30C3	16
IXFQ 20N50P3	52	IXFT 320N10T2	40	➤ IXGA 30N60C3C1	19	➤ IXGJ 50N60C4D1	0, 18

# Alphanumeric Index

> New  
 ○ Not for new design  
 ◇ Under development

IXGK 55N120A3H1	18	IXGT 32N170	19	IXTA 6N100D2	55	IXTC 160N10T	35
IXGK 64N60B3D1	17	IXGT 32N170A	20	IXTA 06N120P	44	IXTC 180N10T	35
IXGK 72N60A3H1	16	IXGT 60N60C3D1	16	IXTA 7N60P	43	IXTC 200N10T	35
IXGK 72N60B3H1	16	IXGT 64N60A3	17	IXTA 08N50D2	55	IXTC 230N085T	35
IXGK 75N250	20	IXGT 64N60B3	17	IXTA 8N50P	42	IXTF 1N250	9, 59
IXGK 82N120A3	18	IXGT 72N60A3	16	IXTA 08N100D2	55	IXTF 1N450	9, 59
IXGK 82N120B3	18	IXGT 72N60B3	17	IXTA 08N100P	44	IXTF 02N450	9, 59
IXGK 100N170	19	IXGX 32N170AH1	20	IXTA 08N120P	44	IXTF 200N10T	9, 35
IXGK 120N60A3	17	IXGX 32N170H1	19	IXTA 10N60P	43	IXTF 280N055T	9, 35
IXGK 120N60B3	17	IXGX 55N120A3H1	18	IXTA 10P15T	57	IXTH 1N250	59
IXGK 120N120A3	18	IXGX 64N60B3D1	17	IXTA 10P50P	56	> IXTH 2N170D2	55
IXGK 120N120B3	18	IXGX 72N60A3H1	17	IXTA 12N50P	42	IXTH 02N250	59
IXGK 320N60A3	17	IXGX 72N60B3H1	17	IXTA 14N60P	43	IXTH 2R4N120P	44
IXGK 320N60B3	17	IXGX 72N60C3H1	17	> IXTA 15N50L2	54	IXTH 3N100P	44
IXGK 400N30A3	16	IXGX 75N250	20	IXTA 15P15T	57	IXTH 3N120	53
IXGL 75N250	20	IXGX 82N120A3	18	IXTA 16N50P	42	IXTH 3N150	53
IXGL 200N60B3	17	IXGX 82N120B3	18	IXTA 18P10T	57	IXTH 4N150	53
IXGN 72N60A3	17	IXGX 100N170	19	IXTA 24P085T	57	IXTH 6N50D2	55
IXGN 72N60C3H1	17	IXGX 120N60A3	17	IXTA 26P10T	57	IXTH 6N100D2	55
IXGN 82N120B3H1	18	IXGX 120N60B3	17	IXTA 26P20P	56	IXTH 6N120	53
IXGN 100N170	19	IXGX 120N120A3	18	IXTA 28P065T	57	IXTH 6N150	53
IXGN 120N60A3	17	IXGX 120N120B3	18	IXTA 32N20T	36	> IXTH 10N100D2	55
IXGN 120N60A3D1	17	IXGX 320N60A3	17	IXTA 32P05T	57	IXTH 10P50P	56
IXGN 200N60B3	17	IXGX 320N60B3	17	IXTA 32P20T	57	IXTH 15N50L2	54
IXGN 320N60A3	17	IXGX 400N30A3	16	IXTA 36N30P	42	> IXTH 16N10D2	55
IXGN 400N30A3	16	IXKC 13N80C	60	IXTA 36P15P	56	IXTH 16N20D2	55
IXGN 400N60A3	17	○ IXKC 15N60C5	60	IXTA 42N15T	35	IXTH 16N50D2	55
IXGN 400N60B3	17	IXKC 20N60C	60	IXTA 42N25P	41	IXTH 16P60P	56
IXGP 12N120A3	18	○ IXKC 25N80C	60	IXTA 44P15T	57	IXTH 20P50P	56
IXGP 20N120A3	18	○ IXKC 40N60C	60	IXTA 48N20T	36	IXTH 22N50P	42
IXGP 20N120B3	18	> IXKF 40N60SCC1	60	IXTA 48P05T	57	IXTH 26N60P	43
IXGP 24N60C4	18	IXKF 40N60SCD1	9, 60	IXTA 50N20P	41	IXTH 26P20P	56
IXGP 24N60C4D1	18	> IXKF 40N60SCH1	9, 60	IXTA 50N25T	36	IXTH 30N50L2	54
IXGP 30N60B4D1	18	○ IXKH 20N60C5	60	IXTA 52P10P	56	IXTH 30N50P	43
IXGP 30N60C3	16	○ IXKH 24N60C5	60	IXTA 56N15T	0	IXTH 30N60L2	54
IXGP 30N60C3C1	16, 19	○ IXKH 30N60C5	60	IXTA 60N10T	35	IXTH 30N60P	43
IXGP 30N60C3D4	16	IXKH 35N60C5	60	IXTA 60N20T	36	IXTH 32P20T	57
IXGP 30N120B3	18	IXKH 47N60C	60	IXTA 62N15P	41	IXTH 36N50P	43
IXGP 36N60A3	17	IXKH 70N60C5	60	IXTA 70N075T2	38	IXTH 36P15P	56
IXGP 42N30C3	16	IXKK 85N60C	60	IXTA 75N10P	41	IXTH 40N50L2	54
IXGP 48N60A3	17	IXKN 40N60C	60	IXTA 76N25T	36	IXTH 44P15T	57
IXGP 48N60B3	17	IXKN 45N80C	60	IXTA 76P10T	57	IXTH 48P20P	56
IXGP 48N60C3	16	IXKN 75N60C	60	IXTA 80N10T	35	IXTH 50N25T	36
IXGP 50N60B4	18	IXKP 10N60C5	60	IXTA 80N10T7	35	IXTH 52P10P	56
IXGP 50N60C4	18	○ IXKP 13N60C5M	60	IXTA 80N12T2	38	IXTH 60N20L2	54
IXGQ 50N60B4D1	18	○ IXKP 20N60C5	60	IXTA 86N20T	36	IXTH 68P20T	57
IXGQ 50N60C4D1	18	○ IXKP 24N60C5	60	IXTA 88N085T	35	IXTH 75N10L2	54
IXGR 6N170A	20	○ IXKP 24N60C5M	60	IXTA 90N055T2	38	IXTH 76N25T	36
IXGR 16N170AH1	20	IXKR 25N80C	60	IXTA 90N075T2	38	IXTH 76P10T	57
IXGR 32N170AH1	20	IXKR 40N60C	60	IXTA 96P085T	57	IXTH 86N25T	36
IXGR 32N170H1	19	IXKR 47N60C5	60	IXTA 100N04T2	38	IXTH 88N30P	42
IXGR 48N60B3	16	IXKT 70N60C5	60	IXTA 102N15T	36	IXTH 90P10P	56
IXGR 48N60B3D1	16	IXKU 5-505	22, 25	IXTA 110N055T2	38	IXTH 96N20P	41
IXGR 48N60C3D1	16	IXLF 19N250A	9, 20	IXTA 110N055T7	35	IXTH 96N25T	36
IXGR 50N160H1	19	IXRB 5-506	22, 25	IXTA 120N04T2	38	IXTH 96P085T	57
IXGR 55N120A3H1	18	IXTA 1N80P	44	IXTA 120N075T2	38	IXTH 102N15T	36
> IXGR 60N60C2C1	19	IXTA 1N100	53	IXTA 120P065T	57	IXTH 102N20T	37
> IXGR 60N60C3C1	19	IXTA 1N100P	44	IXTA 130N065T2	38	IXTH 110N10L2	54
IXGR 60N60C3D1	16	IXTA 1N120P	44	IXTA 130N10T	35	IXTH 110N25T	36
IXGR 64N60A3	17	IXTA 1R4N100P	44	IXTA 130N10T7	35	IXTH 120P065T	57
IXGR 72N60A3	17	IXTA 1R4N120P	44	IXTA 140N055T2	38	IXTH 130N10T	35
IXGR 72N60A3H1	16	IXTA 1R6N100D2	55	IXTA 140P05T	57	IXTH 130N15T	36
IXGR 72N60B3D1	16	IXTA 1R6N50D2	55	IXTA 160N04T2	38	IXTH 130N20T	36
IXGR 72N60B3H1	16	IXTA 2N80P	44	IXTA 160N10T	35	IXTH 140P05T	57
IXGR 72N60C3D1	16	IXTA 2N100	53	IXTA 160N10T7	35	IXTH 140P10T	57
IXGT 2N250	20	IXTA 2N100P	44	IXTA 170N075T2	38	IXTH 160N10T	35
IXGT 4N250C	20	IXTA 02N250	59	IXTA 180N10T	35	IXTH 160N15T	36
IXGT 6N170	19	> IXTA 02N450HV	0, 59	IXTA 180N10T7	35	IXTH 180N10T	35
IXGT 6N170A	20	IXTA 2R4N120P	44	IXTA 200N055T2	38	IXTH 200N10T	35
IXGT 10N170	19	IXTA 3N50D2	55	IXTA 200N055T2-7	38	IXTH 260N055T2	38
IXGT 10N170A	20	IXTA 3N50P	42	IXTA 220N04T2	38	IXTH 300N04T2	38
IXGT 16N170	19	IXTA 3N60P	43	IXTA 220N04T2-7	38	IXTH 360N055T2	38
IXGT 16N170A	20	IXTA 3N100D2	55	IXTA 230N075T2	38	IXTH 420N04T2	38
IXGT 16N170AH1	20	> IXTA 3N100D2HV	0, 55	IXTA 230N075T2-7	38	IXTH 440N055T2	38
IXGT 24N170	19	IXTA 3N100P	44	IXTA 260N055T2	38	IXTH 450P2	51
IXGT 24N170A	20	IXTA 3N120	53	IXTA 260N055T2-7	38	IXTH 460P2	51
IXGT 24N170AH1	20	IXTA 4N60P	43	IXTA 300N04T2	38	IXTH 500N04T2	38
IXGT 25N160	19	IXTA 4N80P	44	IXTA 300N04T2-7	38	IXTK 5N250	59
IXGT 25N250	20	IXTA 5N50P	42	IXTA 460P2	51	IXTK 32P60P	56
> IXGT 25N250HV	0, 20	IXTA 5N60P	43	IXTC 26N50P	42	IXTK 40P50P	56
IXGT 30N60C3D1	16	IXTA 05N100	53	IXTC 36P15P	56	IXTK 60N50L2	54
IXGT 30N120B3D1	18	IXTA 05N100P	44	IXTC 96N25T	36	IXTK 82N25P	41
IXGT 32N100A3	18	IXTA 6N50D2	55	IXTC 110N055T	35	IXTK 88N30P	42
IXGT 32N120A3	18	IXTA 6N50P	42	IXTC 110N25T	36	IXTK 90N25L2	54

# Alphanumeric Index

- New
- Not for new design
- ✦ Under development

IXTK 90P20P	56	IXTP 14N60PM	43	IXTQ 44P15T	57	IXTT 90P10P	56
IXTK 100N25P	41	IXTP 15N50L2	54	IXTQ 48N20T	36	IXTT 96N15P	41
IXTK 102N30P	42	IXTP 15P15T	57	IXTQ 50N20P	41	IXTT 96N20P	41
IXTK 110N20L2	54	IXTP 16N50P	42	IXTQ 50N25T	36	IXTT 100N25P	41
IXTK 120N20P	41	IXTP 16N50PM	42	IXTQ 52N30P	42	IXTT 110N10L2	54
IXTK 120N25P	41	IXTP 18N60PM	43	IXTQ 52P10P	56	IXTT 110N10P	41
IXTK 120P20T	57	IXTP 18P10T	57	IXTQ 60N10T	35	IXTT 120N15P	41
IXTK 140N20P	41	IXTP 22N50PM	42	IXTQ 60N20L2	54	IXTT 140N10P	41
IXTK 140N30P	42	IXTP 24P085T	57	IXTQ 60N20T	36	IXTT 140P10T	57
IXTK 150N15P	41	IXTP 26P10T	57	IXTQ 62N15P	41	IXTT 170N10P	41
IXTK 170N10P	41	IXTP 26P20P	56	IXTQ 64N25P	41	IXTT 360N055T2	38
IXTK 170P10P	56	IXTP 28P065T	57	IXTQ 69N30P	42	IXTT 440N055T2	38
IXTK 180N15P	41	IXTP 32N20T	36	IXTQ 69N30PM	42	IXTT 500N04T2	38
IXTK 200N10L2	54	IXTP 32P05T	57	IXTQ 74N20P	41	IXTU 1N80P	44
IXTK 200N10P	41	IXTP 32P20T	57	IXTQ 75N10P	41	IXTU 01N100	53
IXTK 210P10T	57	IXTP 36N30P	42	IXTQ 76N25T	36	IXTU 1R4N60P	43
IXTK 550N055T2	38	IXTP 36P15P	56	IXTQ 82N25P	41	IXTU 2N80P	44
IXTK 600N04T2	38	IXTP 42N15T	35	IXTQ 86N20T	36	IXTU 4N60P	43
IXTL 2N450	59	IXTP 42N25P	41	IXTQ 86N25T	36	IXTU 5N50P	42
IXTL 2x180N10T	35	IXTP 44N10T	35	IXTQ 88N30P	42	IXTU 05N100	53
IXTN 5N250	59	IXTP 44P15T	57	IXTQ 96N15P	41	IXTU 12N06T	35
IXTN 32P60P	56	IXTP 48N20T	36	IXTQ 96N20P	41	IXTV 18N60P	43
IXTN 40P50P	56	IXTP 48P05T	57	IXTQ 96N25T	36	IXTV 22N50P	42
IXTN 60N50L2	54	IXTP 50N20P	41	IXTQ 100N25P	41	IXTV 22N60P	43
IXTN 90N25L2	54	IXTP 50N20PM	41	IXTQ 102N15T	36	IXTV 26N50P	42
IXTN 90P20P	56	IXTP 50N25T	36	IXTQ 102N20T	36	IXTV 26N60P	43
IXTN 110N20L2	54	IXTP 52P10P	56	IXTQ 110N10P	41	IXTV 30N50P	42
IXTN 120P20T	57	IXTP 56N15T	35	IXTQ 120N15P	41	IXTV 30N60P	43
IXTN 170P10P	56	IXTP 60N10T	35	IXTQ 120N20P	41	IXTV 36N50P	43
IXTN 200N10L2	54	IXTP 60N10TM	35	IXTQ 130N10T	35	IXTV 86N25T	36
IXTN 200N10T	35	IXTP 60N20T	36	IXTQ 130N15T	36	IXTV 96N25T	36
IXTN 210P10T	57	IXTP 62N15P	41	IXTQ 140N10P	41	IXTV 102N20T	36
IXTN 320N10T	35	IXTP 70N075T2	38	IXTQ 150N15P	41	IXTV 200N10T	35
IXTN 550N055T2	38	IXTP 75N10P	41	IXTQ 160N10T	35	IXTV 270N055T2	38
IXTN 600N04T2	38	IXTP 76N25T	36	IXTQ 170N10P	41	IXTX 5N250	59
IXTP 1N80P	44	IXTP 76P10T	57	IXTQ 180N10T	35	IXTX 24N100	53
IXTP 1N100	53	IXTP 80N10T	35	IXTQ 200N10T	35	IXTX 32P60P	56
IXTP 1N100P	44	IXTP 80N12T2	38	IXTQ 450P2	51	IXTX 40P50P	56
IXTP 1N120P	44	IXTP 86N20T	36	IXTQ 460P2	51	IXTX 60N50L2	54
IXTP 1R4N100P	44	IXTP 90N055T2	38	IXTQ 470P2	51	IXTX 90N25L2	54
IXTP 1R4N120P	44	IXTP 90N075T2	38	IXTQ 480P2	51	IXTX 90P20P	56
IXTP 1R4N60P	43	IXTP 96P085T	57	IATR 16P60P	56	IXTX 110N20L2	54
IXTP 1R6N100D2	55	IXTP 98N075T	35	IATR 20P50P	56	IXTX 120P20T	57
IXTP 1R6N50D2	55	IXTP 100N04T2	38	IATR 32P60P	56	IXTX 170P10P	56
IXTP 1R6N50P	42	IXTP 102N15T	0	IATR 36P15P	56	IXTX 200N10L2	54
IXTP 2N60P	43	IXTP 110N055T2	38	IATR 40P50P	56	IXTX 210P10T	57
IXTP 2N80P	44	IXTP 120N04T2	38	IATR 48P20P	56	IXTX 550N055T2	38
IXTP 2N100	53	IXTP 120N075T2	38	IATR 68P20T	57	IXTX 600N04T2	38
IXTP 2N100P	44	IXTP 120P065T	57	IATR 90P10P	56	IXTY 1N80P	44
IXTP 02N120P	44	IXTP 130N065T2	38	IATR 90P20P	56	IXTY 01N100	53
IXTP 2R4N120P	44	IXTP 130N10T	35	IATR 120P20T	57	IXTY 1N100P	44
IXTP 2R4N50P	42	IXTP 140N055T2	38	IATR 140P10T	57	IXTY 1R4N100P	44
IXTP 3N50D2	55	IXTP 140P05T	57	IATR 170P10P	56	IXTY 1R4N60P	43
IXTP 3N50P	42	IXTP 160N04T2	38	IATR 200N10P	41	IXTY 1R6N100D2	55
IXTP 3N60P	43	IXTP 160N10T	35	IATR 210P10T	57	IXTY 1R6N50D2	55
IXTP 3N100D2	55	IXTP 170N075T2	38	➤ IXTT 1N250HV	0, 59	IXTY 1R6N50P	42
IXTP 3N100P	44	IXTP 180N10T	35	➤ IXTT 1N450HV	0, 59	IXTY 2N60P	43
IXTP 3N120	53	IXTP 200N055T2	38	➤ IXTT 2N170D2	55	IXTY 2N80P	44
IXTP 4N60P	43	IXTP 220N04T2	38	➤ IXTT 02N450HV	0, 59	IXTY 2N100P	44
IXTP 4N80P	44	IXTP 230N075T2	38	IXTT 6N120	53	IXTY 02N120P	44
IXTP 5N50P	42	IXTP 260N055T2	38	➤ IXTT 10N100D2	55	IXTY 2R4N50P	42
IXTP 5N60P	43	IXTP 300N04T2	38	IXTT 16N10D2	55	IXTY 3N50P	42
IXTP 05N100	53	IXTP 450P2	51	IXTT 16N20D2	55	IXTY 3N60P	43
IXTP 05N100M	53	IXTP 460P2	51	IXTT 16N50D2	55	IXTY 4N60P	43
IXTP 05N100P	44	IXTQ 10P50P	56	IXTT 16P60P	56	IXTY 5N50P	42
IXTP 6N50D2	55	IXTQ 14N60P	43	IXTT 20P50P	56	IXTY 05N100	53
IXTP 6N50P	42	IXTQ 16N50P	42	IXTT 26N50P	42	IXTY 08N50D2	55
IXTP 6N100D2	55	IXTQ 18N60P	43	IXTT 26N60P	43	IXTY 08N100D2	55
IXTP 06N120P	44	IXTQ 22N50P	42	IXTT 30N50L2	54	IXTY 08N100P	44
IXTP 7N60P	43	IXTQ 22N60P	43	IXTT 30N50P	43	IXTY 10P15T	57
IXTP 7N60PM	43	IXTQ 26N50P	42	IXTT 30N60L2	54	IXTY 12N06T	35
IXTP 08N50D2	55	IXTQ 26N60P	43	IXTT 30N60P	43	IXTY 15P15T	57
IXTP 8N50P	42	IXTQ 26P20P	56	IXTT 36N50P	43	IXTY 18P10T	57
IXTP 8N50PM	42	IXTQ 30N50L2	54	IXTT 40N50L2	54	IXTY 26P10T	57
IXTP 08N100D2	55	IXTQ 30N50P	43	IXTT 48P20P	56	IXTY 32P05T	57
IXTP 08N100P	44	IXTQ 30N60L2	54	IXTT 52N30P	42	IXTY 44N10T	35
IXTP 08N120P	44	IXTQ 30N60P	43	IXTT 60N20L2	54	IXTY 48P05T	57
IXTP 10N60P	43	IXTQ 32P20T	57	IXTT 64N25P	41	IXTY 90N055T2	38
IXTP 10N60PM	43	IXTQ 36N30P	42	IXTT 68P20T	57	IXTZ 550N055T2	38
IXTP 10P15T	57	IXTQ 36N50P	43	IXTT 69N30P	42	➤ IXXA 30N65C3HV	0, 13
IXTP 10P50P	56	IXTQ 36P15P	56	IXTT 74N20P	41	IXXA 50N60B3	13
IXTP 12N50P	42	IXTQ 40N50L2	54	IXTT 75N10L2	54	IXXH 30N60B3	13
IXTP 12N50PM	42	IXTQ 42N25P	41	IXTT 82N25P	41	IXXH 30N60B3D1	13
IXTP 14N60P	43	IXTQ 44N50P	43	IXTT 88N30P	42	IXXH 30N60C3D1	13



# Alphanumeric Index

- > New
- Not for new design
- ◇ Under development

> IXXH 30N65B4	13	◇ MCB 21RK1200DCGLC	4, 63, 64	MCC 224-20io1	86	MCD 72-14io8B	82
> IXXH 40N65B4	13	MCC 19-08io1B	84	MCC 224-22io1	86	MCD 72-16io1B	81
IXXH 50N60B3	13	MCC 19-08io8B	84	MCC 224-24io1	86	MCD 72-16io8B	82
IXXH 50N60B3D1	13	MCC 19-12io1B	84	MCC 225-12io1	86	MCD 72-18io1B	81
IXXH 50N60C3	13	MCC 19-12io8B	84	MCC 225-14io1	86	MCD 72-18io8B	82
IXXH 50N60C3D1	13	MCC 19-14io1B	84	MCC 225-16io1	86	MCD 94-20io1B	82
> IXXH 60N65B4	13	MCC 19-14io8B	84	MCC 225-18io1	86	MCD 94-22io1B	82
> IXXH 60N65B4H1	13	MCC 19-16io1B	84	MCC 250-08io1	86	MCD 95-08io1B	82
> IXXH 60N65C4	13	MCC 19-16io8B	84	MCC 250-12io1	86	MCD 95-08io8B	82
IXXH 75N60B3	13	MCC 21-08io8B	84	MCC 250-14io1	86	MCD 95-12io1B	82
IXXH 75N60B3D1	13	MCC 21-12io8B	84	MCC 250-16io1	86	MCD 95-12io8B	82
IXXH 75N60C3	13	MCC 21-14io8B	84	MCC 250-18io1	86	MCD 95-14io1B	82
IXXH 75N60C3D1	13	MCC 21-16io8B	84	MCC 255-12io1	86	MCD 95-14io8B	82
> IXXH 80N65B4	13	MCC 26-08io1B	84	MCC 255-14io1	86	MCD 95-16io1B	82
> IXXH 80N65B4H1	13	MCC 26-08io8B	84	MCC 255-16io1	86	MCD 95-16io8B	82
IXXH 100N60B3	13	MCC 26-12io1B	84	MCC 255-18io1	86	MCD 95-18io1B	82
IXXH 100N60C3	13	MCC 26-12io8B	84	MCC 310-08io1	86	MCD 95-18io8B	82
> IXXH 110N65C4	13	MCC 26-14io1B	84	MCC 310-12io1	86	MCD 132-08io1	82
IXXK 100N60B3H1	13	MCC 26-14io8B	84	MCC 310-14io1	86	MCD 132-12io1	82
IXXK 100N60C3H1	13	MCC 26-16io1B	84	MCC 310-16io1	86	MCD 132-14io1	82
> IXXK 110N65B4H1	13	MCC 26-16io8B	84	MCC 310-18io1	86	MCD 132-16io1	82
> IXXK 160N65B4	13	MCC 44-08io1B	84	MCC 312-12io1	86	MCD 132-18io1	82
> IXXK 160N65C4	13	MCC 44-08io8B	84	MCC 312-14io1	86	MCD 161-20io1B	82
IXXK 200N60B3	13	MCC 44-12io1B	84	MCC 312-16io1	86	MCD 161-22io1	82
IXXK 200N60C3	13	MCC 44-12io8B	84	MCC 312-18io1	86	MCD 162-08io1	82
> IXXK 200N65B4	13	MCC 44-14io1B	84	MCC 312-18io1	86	MCD 162-12io1	82
IXXK 300N60B3	13	MCC 44-14io8B	84	MCC 320-36io2	137	MCD 162-14io1	82
IXXK 300N60C3	13	MCC 44-16io1B	84	MCC 431-20io2	137	MCD 162-16io1	82
IXXN 100N60B3H1	13	MCC 44-16io8B	84	MCC 431-22io2	137	MCD 162-18io1	82
> IXXN 110N65B4H1	13	MCC 44-18io1B	84	MCC 431-24io2	137	MCD 200-14io1	82
> IXXN 110N65C4H1	13	MCC 44-18io8B	84	○ MCC 500-14io1	137	MCD 200-16io1	82
IXXN 200N60B3	13	MCC 56-08io1B	84	○ MCC 500-18io1	137	MCD 200-18io1	82
IXXN 200N60B3H1	13	MCC 56-08io8B	84	○ MCC 500-22io1	137	MCD 220-08io1	83
IXXN 200N60C3H1	13	MCC 56-12io1B	84	> MCC 500-30io7	137	MCD 220-12io1	83
IXXP 50N60B3	13	MCC 56-12io8B	84	> MCC 500-36io7	137	MCD 220-14io1	83
IXXR 100N60B3H1	13	MCC 56-14io1B	84	MCC 501-12io2	137	MCD 220-16io1	83
> IXXR 110N65B4H1	13	MCC 56-14io8B	84	MCC 501-14io2	137	MCD 224-20io1	83
IXXX 100N60B3H1	13	MCC 56-16io1B	84	MCC 501-16io2	137	MCD 224-22io1	83
IXXX 100N60C3H1	13	MCC 56-16io8B	84	MCC 501-18io2	137	MCD 225-12io1	83
> IXXX 110N65B4H1	13	MCC 56-18io1B	84	> MCC 552-12io2	137	MCD 225-14io1	83
> IXXX 160N65B4	13	MCC 56-18io8B	84	> MCC 552-14io2	137	MCD 225-16io1	83
> IXXX 160N65C4	13	MCC 72-08io1B	85	> MCC 552-16io2	137	MCD 225-18io1	83
IXXX 200N60B3	13	MCC 72-08io8B	85	> MCC 580-28io7	137	MCD 250-08io1	83
IXXX 200N60C3	13	MCC 72-12io1B	85	MCC 600-22io1W	140	MCD 250-12io1	83
> IXXX 200N65B4	13	MCC 72-12io8B	85	> MCC 650-24io7	137	MCD 250-14io1	83
IXXX 300N60B3	13	MCC 72-14io1B	85	MCC 700-14io1W	140	MCD 250-16io1	83
IXXX 300N60C3	13	MCC 72-14io8B	85	MCC 700-18io1W	140	MCD 250-18io1	83
> IXYB 82N120C3H1	14	MCC 72-16io1B	85	> MCC 720-14io7	137	MCD 255-12io1	83
> IXYH 20N120C3	14	MCC 72-16io8B	85	> MCC 720-18io7	137	MCD 255-14io1	83
> IXYH 20N120C3D1	14	MCC 72-18io1B	85	MCD 26-08io1B	81	MCD 255-16io1	83
> IXYH 30N120C3	14	MCC 72-18io8B	85	MCD 26-08io8B	81	MCD 255-18io1	83
> IXYH 30N120C3D1	14	MCC 94-20io1B	85	MCD 26-12io1B	81	MCD 310-08io1	83
> IXYH 40N120B3	14	MCC 94-22io1B	85	MCD 26-12io8B	81	MCD 310-12io1	83
> IXYH 40N120B3D1	14	MCC 94-24io1B	85	MCD 26-14io1B	81	MCD 310-14io1	83
> IXYH 40N120C3	14	MCC 95-08io1B	85	MCD 26-14io8B	81	MCD 310-16io1	83
> IXYH 40N120C3D1	14	MCC 95-08io8B	85	MCD 26-16io1B	81	MCD 310-18io1	83
> IXYH 40N650C3H1	13	MCC 95-12io1B	85	MCD 26-16io8B	81	MCD 310-20io1	83
> IXYH 50N120C3	14	MCC 95-12io8B	85	MCD 40-12io6	81	MCD 310-22io1	83
> IXYH 50N120C3D1	14	MCC 95-14io1B	85	MCD 40-16io6	81	MCD 312-12io1	83
> IXYH 82N120C3	14	MCC 95-14io8B	85	MCD 44-08io1B	81	MCD 312-14io1	83
> IXYJ 20N120C3D1	0, 14	MCC 95-16io1B	85	MCD 44-08io8B	81	MCD 312-16io1	83
> IXYK 100N120B3	14	MCC 95-16io8B	85	MCD 44-12io1B	81	MCD 312-18io1	83
> IXYK 100N120C3	14	MCC 95-18io1B	85	MCD 44-12io8B	81	MCD 320-30io2	138
> IXYK 120N120C3	14	MCC 95-18io8B	85	MCD 44-14io1B	81	MCD 320-36io2	138
> IXYN 82N120C3	14	MCC 132-08io1	85	MCD 44-14io8B	81	MCD 431-20io2	138
> IXYN 82N120C3H1	14	MCC 132-12io1	85	MCD 44-16io1B	81	MCD 431-22io2	138
> IXYN 100N120B3H1	14	MCC 132-14io1	85	MCD 44-16io8B	81	MCD 431-24io2	138
> IXYN 100N120C3	14	MCC 132-16io1	85	MCD 44-18io1B	81	○ MCD 500-14io1	138
> IXYN 100N120C3H1	14	MCC 132-18io1	85	MCD 44-18io8B	81	○ MCD 500-18io1	138
> IXP 20N120C3	14	MCC 161-20io1	85	MCD 56-08io1B	81	○ MCD 500-22io1	138
> IXP 30N120C3	14	MCC 161-22io1	85	MCD 56-08io8B	81	> MCD 500-30io7	138
> IXP 50N120C3D1	14	MCC 162-08io1	85	MCD 56-12io1B	81	> MCD 500-36io7	138
> IXP 100N120C3	14	MCC 162-12io1	85	MCD 56-12io8B	81	MCD 501-12io2	138
> IXYT 20N120C3D1HV	0, 14	MCC 162-14io1	85	MCD 56-14io1B	81	MCD 501-14io2	138
> IXYX 100N120B3	14	MCC 162-16io1	85	MCD 56-14io8B	81	MCD 501-16io2	138
> IXYX 100N120C3	14	MCC 162-18io1	85	MCD 56-16io1B	81	MCD 501-18io2	138
> IXYX 120N120C3	14	MCC 200-14io1	86	MCD 56-16io8B	81	> MCD 552-12io2	138
L		MCC 200-16io1	86	MCD 56-18io1B	81	> MCD 552-14io2	138
LKK 47-06C5	60	MCC 200-18io1	86	MCD 56-18io8B	81	> MCD 552-16io2	138
M		MCC 220-08io1	86	MCD 72-08io1B	81	> MCD 580-28io7	138
MCA 600-22io1W	140	MCC 220-12io1	86	MCD 72-08io8B	82	MCD 600-22io1W	140
MCA 700-14io1W	140	MCC 220-14io1	86	MCD 72-12io1B	81	> MCD 650-24io7	138
MCA 700-18io1W	140	MCC 220-16io1	86	MCD 72-12io8B	82	MCD 700-14io1W	140
◇ MCB 21P1200LC	4	MCC 220-18io1	86	MCD 72-14io1B	81	MCD 700-18io1W	140

# Alphanumeric Index

- New
- Not for new design
- ✦ Under development

➤ MCD 720-14io7	138	○ MDA 600-18N1	139	MDD 220-14N1	80	➤ MDNA 140P2200TG	79
➤ MCD 720-18io7	138	○ MDA 600-22N1	139	MDD 220-16N1	80	MDO 500-12N1	80
MCK 200-18io1	86	➤ MDA 630-30N2	139	MDD 220-18N1	80	MDO 500-14N1	80
○ MCK 500-14io1	137	➤ MDA 630-36N2	139	MDD 250-08N1	80	MDO 500-16N1	80
○ MCK 500-18io1	137	➤ MDA 710-22N2	139	MDD 250-12N1	80	MDO 500-18N1	80
○ MCK 500-22io1	137	➤ MDA 710-26N2	139	MDD 250-14N1	80	MDO 500-20N1	80
MCK 600-22io1W	140	➤ MDA 810-12N2	139	MDD 250-16N1	80	MDO 500-22N1	80
MCK 700-14io1W	140	➤ MDA 810-16N2	139	MDD 255-12N1	80	MDO 600-16N1	80
MCK 700-18io1W	140	➤ MDA 810-18N2	139	MDD 255-14N1	80	➤ MDO 1201-14N1	139
➤ MCMA 25P1200TA	84	MDA 950-14N1W	140	MDD 255-16N1	80	➤ MDO 1201-18N1	139
➤ MCMA 25P1600TA	84	MDA 950-18N1W	140	MDD 255-18N1	80	➤ MDO 1201-22N1	139
➤ MCMA 25PD1200TB	81	MDA 950-22N1W	140	MDD 255-20N1	80	MEA 75-12DA	74
➤ MCMA 25PD1600TB	81	➤ MDA 1080-18N7	139	MDD 255-22N1	80	MEA 95-06DA	74
➤ MCMA 35P1200TA	84	➤ MDA 1080-24N7	139	MDD 310-08N1	80	MEA 250-12DA	74
➤ MCMA 35P1600TA	84	➤ MDA 1080-28N7	139	MDD 310-12N1	80	MEA 300-06DA	74
➤ MCMA 35PD1200TB	81	MDC 320-30io2	138	MDD 310-14N1	80	MEE 75-12DA	74
➤ MCMA 35PD1600TB	81	MDC 320-36io2	138	MDD 310-16N1	80	MEE 95-06DA	74
➤ MCMA 50P1200TA	84	MDC 431-20io2	138	MDD 310-18N1	80	MEE 250-12DA	74
➤ MCMA 50P1600TA	84	MDC 431-22io2	138	MDD 310-20N1	80	MEE 300-06DA	74
➤ MCMA 50PD1200TB	81	MDC 431-24io2	138	MDD 310-22N1	80	MEK 75-12DA	74
➤ MCMA 50PD1600TB	81	○ MDC 500-14io1	138	MDD 312-12N1	80	MEK 95-06DA	74
➤ MCMA 65P1200TA	85	○ MDC 500-18io1	138	MDD 312-14N1	80	MEK 150-04DA	74
➤ MCMA 65P1600TA	85	○ MDC 500-22io1	138	MDD 312-16N1	80	MEK 250-12DA	74
➤ MCMA 65PD1200TB	81	➤ MDC 500-30io7	138	MDD 312-18N1	80	MEK 300-06DA	74
➤ MCMA 65PD1600TB	81	➤ MDC 500-36io7	138	MDD 312-20N1	80	MEK 350-02DA	74
➤ MCMA 85P1200TA	85	MDC 501-12io2	138	MDD 312-22N1	80	MEK 600-04DA	74
➤ MCMA 85P1600TA	85	MDC 501-14io2	138	○ MDD 600-14N1	139	MEO 450-12DA	74
➤ MCMA 85PD1200TB	82	MDC 501-16io2	138	○ MDD 600-18N1	139	MEO 500-06DA	74
➤ MCMA 85PD1600TB	82	MDC 501-18io2	138	○ MDD 600-22N1	139	MEO 550-02DA	74
➤ MCMA 110P1200TA	85	➤ MDC 552-12io2	138	MDD 630-30N2	139	MIAA 10WB600TMH	22
➤ MCMA 110P1600TA	85	➤ MDC 552-14io2	138	MDD 630-36N2	139	MIAA 10WD600TMH	22
➤ MCMA 110PD1200TB	82	➤ MDC 552-16io2	138	MDD 710-22N2	139	MIAA 10WE600TMH	22
➤ MCMA 110PD1600TB	82	➤ MDC 580-28io7	138	MDD 710-26N2	139	MIAA 10WF600TMH	22
MCMA 120UJ1800ED	95	MDC 600-22io1W	140	MDD 810-12N2	139	MIAA 15WB600TMH	22
➤ MCMA 140P1200TA	85	➤ MDC 650-24io7	138	MDD 810-16N2	139	MIAA 15WD600TMH	22
➤ MCMA 140P1400TA	85	MDC 700-14io1W	140	MDD 810-18N2	139	MIAA 15WE600TMH	22
MCMA 140P1600TA	85	MDC 700-18io1W	140	MDD 950-14N1W	140	MIAA 20WB600TMH	22
➤ MCMA 140P1800TA	85	➤ MDC 720-14io7	138	MDD 950-18N1W	140	MIAA 20WD600TMH	22
➤ MCMA 140PD1200TB	82	➤ MDC 720-18io7	138	MDD 950-22N1W	140	MIAA 20WE600TMH	22
➤ MCMA 140PD1600TB	82	MDD 26-08N1B	79	➤ MDD 1080-18N7	139	MID 75-12A3	32
MCMA 200P1600SA	86	MDD 26-12N1B	79	➤ MDD 1080-24N7	139	MID 100-12A3	32
MCMA 200PD1600SA	82	MDD 26-14N1B	79	➤ MDD 1080-28N7	139	MID 145-12A3	32
➤ MCMA 240UI1600ED	94	MDD 26-16N1B	79	MDI 75-12A3	32	MID 150-12A4	32
MCMA 260P1600YA	86	MDD 26-18N1B	79	MDI 100-12A3	32	MID 200-12A4	32
MCMA 260PD1600YB	83	MDD 44-08N1B	79	MDI 145-12A3	32	MID 300-12A4	32
MCMA 265P1600KA	86	MDD 44-12N1B	79	MDI 150-12A4	32	MID 550-12A4	32
MCMA 265PD1600KB	83	MDD 44-14N1B	79	MDI 200-12A4	32	➤ MIEB 76H1200EH	31
➤ MCMA 700P1600CA	86	MDD 44-16N1B	79	MDI 300-12A4	32	➤ MIEB 100W1200DPFTEH	27
➤ MCMA 700PD1600CB	83	MDD 44-18N1B	79	MDI 550-12A4	32	MIEB 100W1200TEH	27
➤ MCNA 40P2200TA	84	MDD 56-08N1B	79	○ MDK 600-14N1	139	➤ MIEB 101H1200EH	31
➤ MCNA 120P2200TA	85	MDD 56-12N1B	79	○ MDK 600-18N1	139	➤ MIEB 101W1200DPFEH	27
➤ MCNA 120PD2200TB	82	MDD 56-14N1B	79	○ MDK 600-22N1	139	MIEB 101W1200EH	27
➤ MCNA 120UI2200TED	94	MDD 56-16N1B	79	➤ MDK 630-30N2	139	➤ MIEB 300W1200TFH	30
MCO 25-12io1	87	MDD 56-18N1B	79	➤ MDK 630-36N2	139	➤ MIEB 450W1200TFH	30
MCO 25-16io1	87	MDD 72-08N1B	79	➤ MDK 710-22N2	139	MII 75-12A3	32
MCO 50-12io1	87	MDD 72-12N1B	79	➤ MDK 710-26N2	139	MII 100-12A3	32
MCO 50-16io1	87	MDD 72-14N1B	79	➤ MDK 810-12N2	139	MII 145-12A3	32
MCO 75-12io1	87	MDD 72-16N1B	79	➤ MDK 810-16N2	139	MII 150-12A4	32
MCO 75-16io1	87	MDD 72-18N1B	79	➤ MDK 810-18N2	139	MII 200-12A4	32
MCO 100-12io1	87	MDD 95-08N1B	79	MDK 950-14N1W	140	MII 300-12A4	32
MCO 100-16io1	87	MDD 95-12N1B	79	MDK 950-18N1W	140	MITA 10WB1200TMH	22
MCO 150-12io1	87	MDD 95-14N1B	79	MDK 950-22N1W	140	MITA 15WB1200TMH	22
MCO 150-16io1	87	MDD 95-16N1B	79	➤ MDK 1080-18N7	139	➤ MITA 30WB600TMH	22
MCO 450-20io1	87	MDD 95-18N1B	79	➤ MDK 1080-24N7	139	MITB 10WB1200TMH	22
MCO 450-22io1	87	MDD 95-20N1B	79	➤ MDK 1080-28N7	139	MITB 15WB1200TMH	22
MCO 500-12io1	87	MDD 95-22N1B	79	➤ MDMA 25P1200TG	79	MIXA 10W1200TMH	25
MCO 500-14io1	87	MDD 142-08N1	79	➤ MDMA 25P1600TG	79	MIXA 10W1200TML	25
MCO 500-16io1	87	MDD 142-12N1	79	➤ MDMA 35P1200TG	79	➤ MIXA 10WB1200TED	23
MCO 500-18io1	87	MDD 142-14N1	79	➤ MDMA 35P1600TG	79	MIXA 10WB1200TMH	22
MCO 600-16io1	87	MDD 142-16N1	79	➤ MDMA 50P1200TG	79	➤ MIXA 10WB1200TML	23
MCO 600-18io1	87	MDD 142-18N1	79	➤ MDMA 50P1600TG	79	MIXA 20W1200MC	25
MCO 600-20io1	87	MDD 172-08N1	79	➤ MDMA 65P1200TG	79	MIXA 20W1200TMH	25
MCO 600-22io1	87	MDD 172-12N1	79	➤ MDMA 65P1600TG	79	MIXA 20W1200TML	25
MCO 741-22io1	137	MDD 172-14N1	79	➤ MDMA 85P1200TG	79	MIXA 20WB1200TED	23
MCO 801-14io1	137	MDD 172-16N1	79	➤ MDMA 85P1600TG	79	MIXA 20WB1200TMH	22
MCO 801-18io1	137	MDD 172-18N1	79	➤ MDMA 110P1200TG	79	➤ MIXA 20WB1200TMI	28
➤ MCR 500-30io7	137	MDD 175-28N1	80	➤ MDMA 110P1600TG	79	➤ MIXA 20WB1200TML	23
➤ MCR 500-36io7	137	MDD 175-34N1	80	➤ MDMA 140P1200TG	79	MIXA 30W1200TED	26
➤ MCR 580-28io7	137	MDD 200-14N1	79	➤ MDMA 140P1600TG	79	MIXA 30W1200TMH	25
➤ MCR 650-24io7	137	MDD 200-16N1	79	➤ MDMA 140P1800TG	79	MIXA 30W1200TML	25
➤ MCR 720-14io7	137	MDD 200-18N1	79	➤ MDMA 200P1600SA	80	➤ MIXA 30WB1200TED	23
➤ MCR 720-18io7	137	MDD 200-22N1	79	MDMA 240UB1600ED	94	➤ MIXA 30WB1200TMI	28
MDA 95-22N1B	79	MDD 220-08N1	80	➤ MDMA 380P1600KC	80	MIXA 40W1200TED	26
○ MDA 600-14N1	139	MDD 220-12N1	80	MDMA 700P1600CC	80	MIXA 40W1200TMH	25

# Alphanumeric Index

> New  
 ○ Not for new design  
 ◇ Under development

MIXA 40W1200TML	25	> MMIX 1X200N60B3	5	MWI 100-06A8	27	VBO 78-12NO7	91
MIXA 40WB1200TED	23	> MMIX 1X200N60B3H1	5	MWI 100-06A8T	27	VBO 78-16NO7	91
> MIXA 50PM650TMI	28	MMO 62-12io6	96	MWI 100-12A8	27	VBO 88-08NO7	91
> MIXA 50W650TED	26	MMO 62-16io6	96	MWI 100-12A8T	27	VBO 88-12NO7	91
> MIXA 50W1200TMI	28	MMO 74-12io6	96	MWI 100-12T8T	27	VBO 88-16NO7	91
> MIXA 50WB600TED	23	MMO 74-16io6	96	MWI 100-17E8T	27	VBO 105-08NO7	91
> MIXA 60HU1200VA	32	MMO 90-12io6	96	MWI 150-06A8	27	VBO 105-12NO7	91
MIXA 60W1200TED	26	MMO 90-14io6	96	MWI 150-06A8T	27	VBO 105-16NO7	91
MIXA 60WB1200TEH	24	MMO 90-16io6	96	MWI 150-12T8T	27	VBO 125-08NO7	91
> MIXA 60WH1200TEH	24	MMO 110-08io7	96	MWI 150-17E8T	27	VBO 125-12NO7	91
> MIXA 61H1200ED	31	MMO 110-12io7	96	MWI 200-06A8	27	VBO 125-16NO7	91
> MIXA 75W650TED	26	MMO 110-14io7	96	MWI 200-06A8T	27	VBO 130-08NO7	91
> MIXA 75W1200TMI	28	MMO 140-08io7	96	MWI 450-17T9	30	VBO 130-12NO7	91
> MIXA 80R1200VA	32	MMO 140-12io7	96	<b>U</b>		VBO 130-16NO7	91
> MIXA 80W1200TED	26	MMO 140-16io7	96	UGB 3132AD	97	VBO 130-18NO7	91
> MIXA 80W1200TEH	27	MMO 175-08io7	96	UGB 6124AG	97	VBO 160-08NO7	91
MIXA 80WB1200TEH	24	MMO 175-12io7	96	UGD 6123AG	97	VBO 160-12NO7	91
> MIXA 81H1200EH	31	MMO 175-16io7	96	UGD 8124AG	97	VBO 160-16NO7	91
> MIXA 81WB1200TEH	24	MMO 230-08io7	96	UGE 0221AY4	97	VBO 160-18NO7	91
> MIXA 100PM650TMI	28	MMO 230-12io7	96	UGE 0421AY4	97	VCO 132-08io7	87
> MIXA 100W1200TEH	27	MMO 230-14io7	96	UGE 1112AY4	97	VCO 132-12io7	87
> MIXA 150Q1200VA	32	MMO 230-16io7	96	UGE 3126AY4	97	VCO 132-14io7	87
> MIXA 150R1200VA	32	MMO 230-18io7	96	<b>V</b>		VCO 132-16io7	87
> MIXA 150W1200TEH	27	> MPA 22R600DHGFC	9, 63, 64	VBE 17-06NO7	89	VCO 132-18io7	87
> MIXA 225PF1200TSF	29	MPK 95-06DA	74	VBE 17-12NO7	89	VCO 180-08io7	87
◇ MIXA 225PF1700TSF	29	◇ MTC 840X75TGD	7, 61	VBE 20-20NO1	89	VCO 180-12io7	87
> MIXA 225RF1200TSF	29	◇ MTC 960X55TGD	7, 61	VBE 26-06NO7	89	VCO 180-14io7	87
MIXA 225W1200TFH	30	> MTI 85W100GC	7, 61	VBE 26-12NO7	89	VCO 180-16io7	87
◇ MIXA 225W1700TFH	30	> MTI 145WX100GD	7, 61	VBE 55-06NO7	89	VCO 180-18io7	87
> MIXA 300PF1200TSF	29	> MTI 200WX75GD	7, 61	VBE 55-12NO7	89	VGB 0124AY7a	97
◇ MIXA 300PF1700TSF	29	MUBW 10-06A6K	23	VBE 60-06A	89	VGF 0136AB	97
MIXA 300W1200TFH	30	MUBW 10-06A7	23	VBE 100-06NO7	89	VGF 0136AH	97
◇ MIXA 300W1700TFH	30	MUBW 10-12A7	23	VBE 100-12NO7	89	VGO 36-16io7	91
> MIXA 430LD1200TSF	29	MUBW 15-06A6K	23	VBH 40-05B	63	VHF 15-08io5	91
> MIXA 450PF1200TSF	29	MUBW 15-06A7	23	VBO 13-08NO2	90	VHF 15-12io5	91
◇ MIXA 450PF1700TSF	29	MUBW 15-12A6K	23	VBO 13-12AO2	90	VHF 15-14io5	91
MIXA 450W1200TFH	30	MUBW 15-12A7	23	VBO 13-12NO2	90	VHF 15-16io5	91
◇ MIXA 450W1700TFH	30	MUBW 15-12T7	23	VBO 13-16AO2	90	VHF 25-08io7	91
> MIXA 600AF650TSF	29	MUBW 20-06A6K	23	VBO 13-16NO2	90	VHF 25-12io7	91
> MIXA 600CF650TSF	29	MUBW 20-06A7	23	VBO 20-08NO2	90	VHF 28-08io5	91
> MIXA 600PF650TSF	29	MUBW 25-06A6K	23	VBO 20-12AO2	90	VHF 28-12io5	91
◇ MIXA 600PF1200TSF	29	MUBW 25-12A7	23	VBO 20-12NO2	90	VHF 28-14io5	91
> MIXA 600W1200TFH	30	MUBW 25-12T7	23	VBO 20-16AO2	90	VHF 28-16io5	91
◇ MIXA 1400PF1200TSP	30	MUBW 30-06A7	23	VBO 20-16NO2	90	VHF 36-08io5	91
◇ MIXA 1400PF1700TSP	30	MUBW 30-12A6K	23	VBO 21-08NO7	90	VHF 36-12io5	91
> MIXB 52HR600DCGED	31	MUBW 35-06A6K	23	VBO 21-12NO7	90	VHF 36-14io5	91
> MIXB 52HR600ED	31	MUBW 35-12A7	23	VBO 22-08NO8	90	VHF 36-16io5	91
> MIXD 80PM650TMI	28	MUBW 35-12A8	24	VBO 22-12NO8	90	VHFD 16-08io1	91
> MIXD 200W650TEH	27	MUBW 40-12T7	23	VBO 22-16NO8	90	VHFD 16-12io1	91
> MKE 11R600DCGFC	9, 60, 63, 64	MUBW 45-12T6K	23	VBO 22-18NO8	90	VHFD 16-16io1	91
MKE 38P600LB	4	MUBW 50-06A7	23	VBO 25-08NO2	90	VHFD 29-08io1	91
MKE 38RK600DFELB	4, 63, 64	MUBW 50-06A8	24	VBO 25-12AO2	90	VHFD 29-12io1	91
◇ MKG 40RK600DCGLB	4, 63, 64	MUBW 50-12A8	24	VBO 25-12NO2	90	VHFD 29-16io1	91
◇ MKG 40RK600LB	4, 63, 64	MUBW 50-12T8	24	VBO 25-16AO2	90	VHFD 37-08io1	91
MKI 50-06A7	31	MUBW 50-17T8	24	VBO 25-16NO2	90	VHFD 37-12io1	91
MKI 50-06A7T	31	MUBW 75-06A8	24	VBO 30-08NO7	90	VHFD 37-16io1	91
MKI 50-12F7	31	MUBW 75-12T8	24	VBO 30-12NO7	90	VKM 40-06P1	63
MKI 65-06A7T	31	MUBW 75-17T8	24	VBO 30-16NO7	90	○ VMK 90-02T2	62
MKI 75-06A7	31	MUBW 100-06A8	24	VBO 30-18NO7	90	○ VMM 45-02F	62
MKI 75-06A7T	31	MWI 15-12A6K	25	VBO 36-08NO8	90	○ VMM 90-09F	62
MKI 80-06T6K	31	MWI 15-12A7	26	VBO 36-12NO8	90	> VMM 90-09P	62
MKI 100-12F8	31	MWI 25-12A7	26	VBO 36-16NO8	90	○ VMM 300-03F	62
> MMIX 1F40N110P	4	MWI 25-12A7T	26	VBO 36-18NO8	90	○ VMM 650-01F	62
> MMIX 1F44N100Q3	4	MWI 30-06A7	26	VBO 40-08NO6	90	○ VMO 60-05F	62
> MMIX 1F132N50P3	4	> MWI 30-06A7-S	31	VBO 40-12NO6	90	○ VMO 550-01F	62
> MMIX 1F160N30T	4	MWI 30-06A7T	26	VBO 40-16NO6	90	○ VMO 580-02F	62
> MMIX 1F180N25T	4	MWI 35-12A7	26	VBO 50-08NO7	90	○ VMO 650-01F	62
> MMIX 1F210N30P3	4	MWI 35-12A7T	26	VBO 50-12NO7	90	VMO 1200-01F	62
> MMIX 1F230N20T	4	MWI 35-12T7T	26	VBO 50-16NO7	90	VTO 39-08ho7	95
MMIX 1F360N15T2	4	MWI 45-12T6K	25	VBO 50-18NO7	90	VTO 39-12ho7	95
> MMIX 1F420N10T	4	MWI 50-06A7	26	VBO 52-08NO7	90	VUB 72-12NOXT	94
MMIX 1F520N075T2	4, 39, 61	> MWI 50-06A7-S	31	VBO 52-12NO7	90	VUB 72-16NOXT	94
> MMIX 1G75N250	5	MWI 50-06A7T	26	VBO 52-16NO7	90	VUB 116-16NOXT	94
> MMIX 1G120N120A3H1	5	MWI 50-12A7	26	VBO 52-18NO7	90	VUB 120-16NOX	94
> MMIX 1G320N60B3	5, 17	MWI 50-12A7T	26	VBO 54-08NO7	90	VUB 120-16NOXT	94
MMIX 1T550N055T2	4, 39, 61	MWI 50-12T7T	26	VBO 54-12NO7	90	VUB 135-22NO1	94
MMIX 1T600N04T2	4, 39, 61	MWI 60-12T6K	25	VBO 54-16NO7	90	VUB 145-16NOXT	94
> MMIX 1Y82N120C3H1	5	MWI 75-06A7	26	VBO 68-08NO7	90	VUB 160-16NOX	94
> MMIX 1Y100N120C3H1	5	MWI 75-06A7T	26	VBO 68-12NO7	90	VUB 160-16NOXT	94
> MMIX 2S50N60B4D1	5	MWI 75-12A8	27	VBO 68-16NO7	90	VUC 36-12go2	95
> MMIX 4B12N300	5	MWI 75-12A8T	27	VBO 72-08NO7	90	VUC 36-16go2	95
> MMIX 4B20N300	5	MWI 75-12T7T	26	VBO 72-12NO7	90	VUE 22-06NO7	89
> MMIX 4G20N250	5	MWI 75-12T8T	27	VBO 72-16NO7	90	VUE 22-12NO7	89
> MMIX 1X100N60B3H1	5	MWI 80-12T6K	25	VBO 78-08NO7	91	VUE 30-20NO1	89

# Alphanumeric Index

- New
- Not for new design
- ✦ Under development

VUE 35-06NO7	89	VUO 82-14NO7	93	<b>IXYS ICD</b>		<b>IXYS UK</b>	
VUE 35-12NO7	89	VUO 82-16NO7	93	CPC1580	105	A0516YC240	133
VUE 50-12NO1	89	VUO 82-18NO7	93	CPC1590	105	A0516YC280	133
VUE 75-06NO7	89	➤ VUO 84-16NO7	93	CPC1706Y	101	A1237NC240	133
VUE 75-12NO7	89	VUO 86-08NO7	93	CPC1708J	101	A1237NC280	133
VUE 130-06NO7	89	VUO 86-12NO7	93	CPC1709J	101	C0044BG400SBA	136
VUE 130-12NO7	89	VUO 86-14NO7	93	CPC1718J	101	C0044BG400SBB	136
VUI 30-12N1	64	VUO 86-16NO7	93	CPC1726Y	101	C0044BG400SBC	136
VUI 72-16NOXT	94	VUO 98-08NO7	93	CPC1727J	101	C0044BG400SBD	136
○ VUM 24-05N	64	VUO 98-12NO7	93	CPC1777J	101	C0044BG400SBE	136
VUM 25-05E	64	VUO 98-14NO7	93	CPC1779J	101	C0044BG400SBF	136
○ VUM 33-05N	64	VUO 98-16NO7	93	CPC1786J	101	C0044BG400SBG	136
➤ VUM 33-06PH	64	VUO 105-12NO7	93	CPC1788J	101	C0044BG400SBH	136
VUM 85-05A	64	VUO 105-14NO7	93	CPC1906Y	101	C0044BG400SBJ	136
VUO 22-08NO1	92	VUO 105-16NO7	93	CPC1907B	101	C0044BG400SBK	136
VUO 22-12NO1	92	VUO 105-18NO7	93	CPC1908J	101	C0044BG400SBL	136
VUO 22-14NO1	92	VUO 110-08NO7	93	CPC1909J	101	C0044BG400SBM	136
VUO 22-16NO1	92	VUO 110-12NO7	93	CPC1916Y	101	C0044BG400SBP	136
VUO 22-18NO1	92	VUO 110-14NO7	93	CPC1918J	101	C0044BG400SBQ	136
VUO 25-08NO8	92	VUO 110-16NO7	93	CPC1926Y	101	C0044BG400SBR	136
VUO 25-12NO8	92	VUO 110-18NO7	93	CPC1927J	101	C0044BG400SBS	136
VUO 25-14NO8	92	○ VUO 120-12NO1	93	CPC1943	102	C0044BG400SBT	136
VUO 25-16NO8	92	➤ VUO 120-12NO2T	93	CPC1945G	102	C0044BG400SBV	136
VUO 25-18NO8	92	○ VUO 120-16NO1	93	CPC1945Y	102	E0170YH40C	117
VUO 28-08NO7	92	➤ VUO 120-16NO2T	93	CPC1961	102	E0170YH45C	117
VUO 28-12NO7	92	VUO 121-16NO1	93	CPC1963	102	E0280YH20C	117
VUO 30-08NO3	92	VUO 122-08NO7	93	CPC1964B	102	E0280YH25C	117
VUO 30-12NO3	92	VUO 122-12NO7	93	CPC1965G	102	E0460QC40C	117
VUO 30-14NO3	92	VUO 122-14NO7	93	CPC1965Y	102	E0460QC45C	117
VUO 30-16NO3	92	VUO 122-16NO7	93	CPC1966	102	E0660NC40C	117
VUO 30-18NO3	92	VUO 125-12NO7	93	➤ CPC1966B	102	E0660NC45C	117
VUO 34-08NO1	92	VUO 125-14NO7	93	CPC1967J	101	E0660NH40C	117
VUO 34-12NO1	92	VUO 125-16NO7	93	CPC1968J	101	E0660NH45C	117
VUO 34-14NO1	92	VUO 125-18NO7	93	CPC1972	102	E0800QC20C	117
VUO 34-16NO1	92	VUO 160-08NO7	94	CPC1973Y	101	E0800QC25C	117
VUO 34-18NO1	92	VUO 160-12NO7	94	CPC1976	102	E1200NC20C	117
VUO 35-08NO7	92	VUO 160-14NO7	94	CPC1977J	101	E1200NC25C	117
VUO 35-12NO7	92	VUO 160-16NO7	94	CPC1978J	101	E1200NH20C	117
VUO 35-14NO7	92	VUO 160-18NO7	94	CPC1979J	101	E1200NH25C	117
VUO 35-16NO7	92	VUO 162-16NO7	94	CPC1981Y	101	E1300VF40C	117
VUO 35-18NO7	92	VUO 190-08NO7	94	CPC1983Y	101	E1300VF45C	117
VUO 36-08NO8	92	VUO 190-12NO7	94	CPC1983YE	101	E1500NC36P	117
VUO 36-12NO8	92	VUO 190-14NO7	94	CPC1986J	101	E1500NC42P	117
VUO 36-14NO8	92	VUO 190-16NO7	94	CPC1988J	101	E1500NC48P	117
VUO 36-16NO8	92	VUO 190-18NO7	94	CPC1998	102	E1500NH36P	117
VUO 36-18NO8	92	VUO 192-16NO7	94	➤ CPC40055	102	E1500NH42P	117
VUO 50-08NO3	92	VVZ 12-12io1	95	➤ CPC44055	102	E1500NH48P	117
VUO 50-12NO3	92	VVZ 12-16io1	95	CPC9909	106	E2000NC140	117
VUO 50-14NO3	92	VVZ 24-12io1	95	IX2127	104	E2000NC170	117
VUO 50-16NO3	92	VVZ 24-16io1	95	➤ IX3120	104	E2000NH140	117
VUO 50-18NO3	92	VVZ 39-08ho7	95	IX4423	103	E2000NH170	117
VUO 52-08NO1	92	VVZ 39-12ho7	95	IX4424	103	E2250VF20C	117
VUO 52-12NO1	92	VVZ 40-12io1	95	IX4425	103	E2250VF25C	117
VUO 52-14NO1	92	VVZ 40-16io1	95	IX4426	103	E2400TC40C	117
VUO 52-16NO1	92	VVZ 110-12io7	95	IX4427	103	E2400TC45C	117
VUO 52-18NO1	92	VVZ 175-12io7	95	IX4428	103	E4000TC20C	117
VUO 52-20NO1	92	VVZ 175-16io7	95	IXD_602	103	E4000TC25C	117
VUO 52-22NO1	92	VVZB 120-16ioX	94	IXD_604	103	E53.H59-102T1W	154
VUO 55-12NO7	92	VVZB 135-16ioXT	94	IXD_609	103	E53.H59-123T1W	154
VUO 55-14NO7	92	VVZB 170-16ioXT	94	IXD_614	103	E53.H59-152T1W	154
VUO 55-16NO7	92	○ VVZF 70-16io7	95	IXD_630	103	E53.H59-153T1W	154
VUO 55-18NO7	92	VW 2x30-12io1	96	IXD_630M	103	E53.H59-252T1W	154
VUO 60-12NO3	92	VW 2x30-14io1	96	MXHV9910	106	E53.H59-303T1W	154
VUO 60-14NO3	92	VW 2x30-16io1	96	PD1201	102	E53.H59-332T1W	154
VUO 60-16NO3	92	VW 2x45-12io1	96	PD2401	102	E53.H59-333T1W	154
VUO 60-18NO3	92	VW 2x45-14io1	96	PD2601	102	E53.H59-471T1W	154
VUO 62-08NO7	93	VW 2x45-16io1	96	PM1204	102	E53.H59-472T1W	154
VUO 62-12NO7	93	VW 2x60-12io1	96	PM1205	102	E53.H59-503T1W	154
VUO 62-14NO7	93	VW 2x60-14io1	96	PM1206	102	E53.H59-802T1W	154
VUO 62-16NO7	93	VW 2x60-16io1	96	PS1201	102	E53.M59-103T2W	154
VUO 62-18NO7	93	VVO 35-08ho7	96	PS2401	102	E53.M59-163T2W	154
➤ VUO 64-16NO7	93	VVO 35-12ho7	96	PS2601	102	E53.M59-252T2W	154
VUO 68-08NO7	93	VVO 85-12io1	96			E53.M59-253T2W	154
VUO 68-12NO7	93	VVO 85-14io1	96			E53.M59-332T2W	154
VUO 68-14NO7	93	VVO 85-16io1	96			E53.M59-602T2W	154
VUO 68-16NO7	93	VVO 140-12io1	96			E53.M59-802T2W	154
○ VUO 70-16NO7	93	VVO 140-14io1	96			E53.N51-303H1W	154
VUO 80-08NO1	93	VVO 140-16io1	96			E53.N51-383H1W	154
VUO 80-12NO1	93					E53.N51-503H1W	154
VUO 80-14NO1	93					E53.N68-403H1W	154
VUO 80-16NO1	93					E53.N68-503H1W	154
VUO 80-18NO1	93					E53.P59-103T2W	154
VUO 82-08NO7	93						
VUO 82-12NO7	93						

# Alphanumeric Index

- > New
- Not for new design
- ◇ Under development

E53.P59-143T2W	154	K0566LG440	124	L0001HC600XXX	147	M0872LC210	114
E53.P59-163T2W	154	K0566LG480	124	L0001NC600XXX	147	M0914LC200	112
E53.P59-303T2W	154	K0566LG520	124	L0001QC600XXX	147	M0914LC250	112
E53.P59-402T2W	154	> K0620QA600	124	L0001TC600XXX	147	M0955LC200	114
E53.P59-503T2W	154	> K0620QA650	124	L0001YC600XXX	147	M0955LC250	114
E53.P59-682T2W	154	> K0620QE600	124	L0001ZF600XXX	147	M1010NC400	112
E53.P59-752T2W	154	> K0620QE650	124	M0130RL200	113	M1010NC450	112
E53.Q59-103T2W	154	K0682LC360	124	M0130RL250	113	M1010ND400	112
E53.Q59-143T2W	154	K0682LC420	124	M0130SL200	113	M1010ND450	112
E53.Q59-153T2W	154	K0682LG360	124	M0130SL250	113	M1022LC120	114
E53.Q59-183T2W	154	K0682LG420	124	M0139RL120	113	M1022LC160	114
E53.Q59-223T2W	154	K0769NC600	124	M0139RL180	113	M1022LC200	114
E53.Q59-403T2W	154	K0769NC650	124	M0139SL120	113	M1080LC100	115
E53.Q59-502T2W	154	K0769NG600	124	M0139SL180	113	M1080LC120	115
E53.Q59-602T2W	154	K0769NG650	124	M0225YH360	114	M1102NC500	115
E53.Q59-802T2W	154	K0885NC450	124	M0225YH450	114	M1102NC600	115
E53.R11-302T2W	154	K0885NC480	124	M0268RC200	113	M1102ND500	115
E53.R11-402T2W	154	K0885NC520	124	M0268RC250	113	M1102ND600	115
E53.R60-123T2W	154	K0885NG450	124	M0268RJ200	113	M1104NC400	115
E53.R60-183T2W	154	K0885NG480	124	M0268RJ250	113	M1104NC450	115
E53.R60-243T2W	154	K0885NG520	124	M0268SC200	113	M1104ND400	115
E53.R60-333T2W	154	K0890NC360	124	M0268SC250	113	M1104ND450	115
E53.R60-503T2W	154	K0890NC420	124	M0268SJ200	113	M1163NC400	112
E53.R60-702T2W	154	> K1000MA600	124	M0268SJ250	113	M1163NC450	112
F0240YC250	116	> K1000MA650	124	M0280RC200	113	M1163ND400	112
F0240YC300	116	> K1000ME600	124	M0280RC250	113	M1163ND450	112
F0240YH250	116	> K1000ME650	124	M0280RJ200	113	M1242NC260	115
F0240YH300	116	K1120NC360	124	M0280RJ250	113	M1242NC360	115
F0300WC140	116	K1120NC420	124	M0280SC200	113	M1242ND260	115
F0300WC180	116	K1120NG360	124	M0280SC250	113	M1242ND360	115
F0800LC140	116	K1120NG420	124	M0280SJ200	113	M1494NC180	115
F0800LC180	116	K1121NC320	124	M0280SJ250	113	M1494NC250	115
F0900VC450	116	K1121NC360	124	M0310YH300	114	M1494ND180	115
F0900VC520	116	K1197NC300	124	M0310YH350	114	M1494ND250	115
F0900VF450	116	K1197NC320	124	M0334RC160	113	M1502NC200	112
F0900VF520	116	K1351VC600	124	M0334RC200	113	M1502NC250	112
F1000LC080	116	K1351VC650	124	M0334RJ160	113	M1502ND200	112
F1000LC120	116	K1351VF600	124	M0334RJ200	113	M1502ND250	112
F1300NC45P	116	K1351VF650	124	M0334SC160	113	M1565VC360	115
F1300NC50P	116	K1947ZC400	124	M0334SC200	113	M1565VC400	115
F1300NC55P	116	K1947ZC450	124	M0334SJ160	113	M1565VC450	115
F1300NH45P	116	K1947ZD400	124	M0334SJ200	113	M1565VF360	115
F1300NH50P	116	K1947ZD450	124	M0336RA120	113	M1565VF400	115
F1300NH55P	116	K2065VC360	125	M0336RA140	113	M1565VF450	115
F1400NC140	116	K2065VC420	125	M0336SA120	113	M1583VC400	112
F1400NC180	116	K2065VF360	125	M0336SA140	113	M1583VC450	112
F1400ND140	116	K2065VF420	125	M0347WC200	114	M1583VF400	112
F1400ND180	116	K2095ZC360	125	M0347WC250	114	M1583VF450	112
F1500NC200	116	K2095ZC420	125	M0358WC120	114	M1609NC200	112
F1500NC250	116	K2095ZD360	125	M0358WC180	114	M1609NC260	112
F1600NC080	116	K2095ZD420	125	M0367WC220	114	M1609ND200	112
F1600NC120	116	K2359TC600	125	M0367WC280	114	M1609ND260	112
G1000NC450	134	K2359TC650	125	M0371YH350	114	M1858NC120	115
G1000QC250	134	K2359TD600	125	M0371YH450	114	M1858NC160	115
G1000QC450	134	K2359TD650	125	M0433WC120	114	M1858ND120	115
G2000HF250	134	K2623TC450	125	M0433WC160	114	M1858ND160	115
G2000HF450	134	K2623TC480	125	M0433WC200	114	M2273VC300	112
G2500HF250	134	K2623TC520	125	M0437WC080	114	M2273VC360	112
G3000TF250	134	K2623TD450	125	M0437WC140	114	M2273VF300	112
G3000TF450	134	K2623TD480	125	M0451YC160	114	M2273VF360	112
G4000EC450	134	K2623TD520	125	M0451YC200	114	M2322ZC300	115
H0500KC200	134	K2960TC450	125	M0588LC400	112	M2322ZC400	115
H0500KC20Y	134	K2960TC480	125	M0588LC450	112	M2322ZD300	115
H0500KC25D	134	K2960TC520	125	M0659LC400	114	M2322ZD400	115
H0500KC25Y	134	K2960TD450	125	M0659LC450	114	M2408NC020	112
H0700KC140	134	K2960TD480	125	M0710LC560	114	M2408NC060	112
H0700KC14Y	134	K2960TD520	125	M0710LC600	114	M2408ND020	112
H0700KC17D	134	K2973FC600	125	M0736LC400	114	M2408ND060	112
H0700KC17Y	134	K2973FC650	125	M0736LC450	114	M2413VC200	115
H1200NC200	134	K2973FD600	125	M0759YC120	114	M2413VC250	115
H1200NC20Y	134	K2973FD650	125	M0759YC160	114	M2413VF250	115
H1200NC25D	134	K3207EC450	125	M0759YH120	114	M2639ZC420	112
H1200NC25Y	134	K3207EC480	125	M0759YH160	114	M2639ZC450	112
K0349LC600	124	K3207EC520	125	M0790YC200	112	M2639ZD420	112
K0349LC650	124	K3362TC360	125	M0790YC250	112	M2639ZD450	112
K0349LG600	124	K3362TC420	125	M0790YH200	112	M2698ZC250	112
K0349LG650	124	K3362TD360	125	M0790YH250	112	M2698ZC280	112
K0443LC600	124	K3362TD420	125	M0859LC140	114	M2698ZC350	112
K0443LC650	124	K3503FC450	125	M0859LC160	114	M2698ZD250	112
K0443LG600	124	K3503FC480	125	M0863LC260	114	M2698ZD280	112
K0443LG650	124	K3503FC520	125	M0863LC300	114	M2698ZD350	112
K0566LC440	124	K3503FD450	125	M0863LC360	114	M2837VC180	112
K0566LC480	124	K3503FD480	125	M0872LC140	114	M2837VC250	112
K0566LC520	124	K3503FD520	125	M0872LC180	114		

# Alphanumeric Index

- New
- Not for new design
- ✦ Under development

M2837VF180	112	➤ MDA810-12N2	139	○ N0606YS240	119	N2015ML220	120
M2837VF250	112	➤ MDA810-16N2	139	○ N0606YS250	119	N2046NC120	120
M3770ZC200	112	➤ MDA810-18N2	139	N0616LC400	119	N2046NC160	120
M3770ZC240	112	MDA950-14N1W	140	N0616LC450	119	N2083QK080	121
M3770ZC300	112	MDA950-18N1W	140	N0634LC380	119	N2083QK120	121
M3770ZD200	112	MDA950-22N1W	140	N0634LC420	119	N2083QK140	121
M3770ZD240	112	MDC320-30io2	138	N0646LC300	119	N2086NC060	121
M3770ZD300	112	MDC320-36io2	138	N0646LC360	119	N2086NC100	121
MCA600-22io1W	140	MDC431-20io2	138	○ N0676YS120	119	N2154JK020	121
MCA700-14io1W	140	MDC431-22io2	138	○ N0676YS180	119	N2154JK040	121
MCA700-18io1W	140	MDC431-24io2	138	○ N0734YS120	119	N2154JK060	121
MCC320-30io2	137	○ MDC500-14io1	138	○ N0734YS160	119	N2172ZC400	121
MCC320-36io2	137	○ MDC500-18io1	138	○ N0782YS120	119	N2172ZC450	121
MCC431-20io2	137	○ MDC500-22io1	138	○ N0782YS160	119	N2172ZD400	121
MCC431-22io2	137	○ MDC500-30io7	138	➤ N0795YN140	119	N2172ZD450	121
MCC431-24io2	137	➤ MDC500-36io7	138	➤ N0795YN180	119	N2191ML160	121
○ MCC500-14io1	137	MDC501-12io2	138	N0845NC600	119	N2191ML180	121
○ MCC500-18io1	137	MDC501-14io2	138	N0845NC650	119	N2293VC180	121
○ MCC500-22io1	137	MDC501-16io2	138	N0845NG600	119	N2293VC220	121
➤ MCC500-30io7	137	MDC501-18io2	138	N0845NG650	119	N2293VF180	121
➤ MCC500-36io7	137	➤ MDC552-12io2	138	N0882NC400	119	N2293VF220	121
MCC501-12io2	137	➤ MDC552-14io2	138	N0882NC450	119	N2367MK200	121
MCC501-14io2	137	➤ MDC552-16io2	138	N0910LC200	119	N2367MK220	121
MCC501-16io2	137	➤ MDC580-28io7	138	N0910LC260	119	N2418ZC300	121
MCC501-18io2	137	MDC600-22io1W	140	N1010NC300	119	N2418ZC360	121
➤ MCC552-12io2	137	➤ MDC650-24io7	138	N1010NC380	119	N2418ZD300	121
➤ MCC552-14io2	137	MDC700-14io1W	140	➤ N1075LN180	119	N2418ZD360	121
➤ MCC552-16io2	137	MDC700-18io1W	140	○ N1114LC120	119	N2500VC120	121
➤ MCC580-28io7	137	➤ MDC720-14io7	138	○ N1114LC180	119	N2500VC160	121
MCC600-22io1W	140	➤ MDC720-18io7	138	N1132NC300	119	N2500VF120	121
➤ MCC650-24io7	137	➤ MDD1080-18N7	139	N1132NC320	119	N2500VF160	121
MCC700-14io1W	140	➤ MDD1080-24N7	139	➤ N1140LN140	119	N2520ML080	121
MCC700-18io1W	140	➤ MDD1080-28N7	139	N1159NC380	119	N2520ML120	121
➤ MCC720-14io7	137	○ MDD600-14N1	139	N1159NC420	119	N2520ML140	121
➤ MCC720-18io7	137	○ MDD600-18N1	139	N1174JK200	119	N2543ZC240	121
MCD320-30io2	138	○ MDD600-22N1	139	N1174JK220	119	N2543ZC300	121
MCD320-36io2	138	MDD630-30N2	139	N1263JK160	119	N2543ZD240	121
MCD431-20io2	138	MDD630-36N2	139	N1263JK180	119	N2543ZD300	121
MCD431-22io2	138	MDD710-22N2	139	N1265LC120	119	N2593MK160	121
MCD431-24io2	138	MDD710-26N2	139	○ N1265LC160	119	N2593MK180	121
○ MCD500-14io1	138	MDD810-12N2	139	N1314NC300	120	➤ N2825TE400	121
○ MCD500-18io1	138	MDD810-16N2	139	N1314NC360	120	➤ N2825TE450	121
○ MCD500-22io1	138	MDD810-18N2	139	N1351VC400	120	➤ N2825TJ400	121
➤ MCD500-30io7	138	MDD950-14N1W	140	N1351VC450	120	➤ N2825TJ450	121
➤ MCD500-36io7	138	MDD950-18N1W	140	N1351VF400	120	➤ N2900QL020	121
MCD501-12io2	138	MDD950-22N1W	140	N1351VF450	120	➤ N2900QL040	121
MCD501-14io2	138	➤ MDK1080-18N7	139	N1366JK080	120	➤ N2900QL060	121
MCD501-16io2	138	➤ MDK1080-24N7	139	N1366JK120	120	N3012ZC200	121
MCD501-18io2	138	➤ MDK1080-28N7	139	N1366JK140	120	N3012ZC260	121
➤ MCD552-12io2	138	○ MDK600-14N1	139	N1449QL200	120	N3012ZD200	121
➤ MCD552-14io2	138	○ MDK600-18N1	139	N1449QL220	120	N3012ZD260	121
➤ MCD552-16io2	138	○ MDK600-22N1	139	N1467NC200	120	N3022MK080	122
➤ MCD580-28io7	138	➤ MDK630-30N2	139	N1467NC260	120	N3022MK120	122
MCD600-22io1W	140	➤ MDK630-36N2	139	N1479NC240	120	N3022MK140	122
➤ MCD650-24io7	138	➤ MDK710-22N2	139	➤ N1479NC24R	120	N3029ZC240	122
MCD700-14io1W	140	➤ MDK710-26N2	139	N1479NC300	120	N3029ZC280	122
MCD700-18io1W	140	➤ MDK810-12N2	139	➤ N1479NC30R	120	N3029ZD240	122
➤ MCD720-14io7	138	➤ MDK810-16N2	139	N1547NC160	120	N3029ZD280	122
➤ MCD720-18io7	138	➤ MDK810-18N2	139	N1547NC200	120	N3229QK020	122
○ MCK500-14io1	137	MDK950-14N1W	140	N1581QL160	120	N3229QK040	122
○ MCK500-18io1	137	MDK950-18N1W	140	N1581QL180	120	N3229QK060	122
○ MCK500-22io1	137	MDK950-22N1W	140	N1588NC200	120	○ N3493TC360	122
MCK600-22io1W	140	➤ MDO1201-14N1	139	N1588NC260	120	○ N3493TC420	122
MCK700-14io1W	140	➤ MDO1201-18N1	139	N1651QK200	120	○ N3493TD360	122
MCK700-18io1W	140	➤ MDO1201-22N1	139	N1651QK220	120	○ N3493TD420	122
MCO741-22io1	137	N0131SH120	118	N1661VC300	120	N3533ZC180	122
MCO801-14io1	137	N0131SH160	118	N1661VC360	120	N3533ZC220	122
MCO801-18io1	137	N0180SH120	118	N1661VF300	120	N3533ZD180	122
➤ MCR500-30io7	137	N0180SH160	118	N1661VF360	120	N3533ZD220	122
➤ MCR500-36io7	137	○ N0255WC120	119	N1712VC240	120	N3597ML020	122
➤ MCR580-28io7	137	○ N0255WC160	119	N1712VC300	120	N3597ML040	122
➤ MCR650-24io7	137	N0290SC120	118	N1712VF240	120	N3597ML060	122
➤ MCR720-14io7	137	N0290SC160	118	N1712VF300	120	➤ N3790TE240	122
➤ MCR720-18io7	137	N0335SC120	118	N1718NC120	120	➤ N3790TE280	122
➤ MDA1080-18N7	139	N0335SC160	118	N1718NC180	120	➤ N3790TJ240	122
➤ MDA1080-24N7	139	○ N0392WC120	119	N1718NC200	120	➤ N3790TJ280	122
➤ MDA1080-28N7	139	○ N0392WC160	119	N1802NC120	120	N3839TC300	122
○ MDA600-14N1	139	N0416SC040	118	N1802NC160	120	N3839TC350	122
○ MDA600-18N1	139	N0416SC080	118	N1806QK160	120	N3839TD300	122
○ MDA600-22N1	139	➤ N0465WN140	119	N1806QK180	120	N3839TD350	122
➤ MDA630-30N2	139	➤ N0465WN160	119	N1817QL080	120	N3880ZD160	122
➤ MDA630-36N2	139	➤ N0530YN220	119	N1817QL160	120	N3880ZD180	122
➤ MDA710-22N2	139	➤ N0530YN250	119	N1817QL180	120	N3904HK200	122
➤ MDA710-26N2	139	○ N0606YS200	119	N2015ML200	120	N3904HK220	122

# Alphanumeric Index

- New
- Not for new design
- ◇ Under development

N3930ZC120	122	P0366WC08B	127	R0964LC12C	128	R1448NC14J	130
N3930ZC160	122	P0366WC08C	127	R0964LC12D	129	R1448NC18H	130
N3930ZD120	122	P0367WC12E	127	R0964LC12E	129	R1448NC18J	130
N3930ZD160	122	P0367WC12F	127	R0990LC08A	129	R1448NC20H	130
N4085ZC080	122	P0389WC04B	127	R0990LC08B	129	R1448NC20J	130
N4085ZC120	122	P0389WC04C	127	R0990LC08C	129	R1448NC20K	130
N4085ZD080	122	P0389WC08B	127	R1124NC18J	129	R1448NC20L	130
N4085ZD120	122	P0389WC08C	127	R1124NC18K	129	R1448NC20M	130
N4151FC360	122	P0431SC04B	126	R1124NC18L	129	R1700MC18E	130
N4151FC420	122	P0431SC04C	126	R1124NC18M	129	R1700MC18F	130
N4151FD360	122	P0431SC06B	126	R1124NC20J	129	R1700MC18G	130
N4151FD420	122	P0431SC06C	126	R1124NC20K	129	R1700MC18H	130
N4316MK020	122	P0515WC04B	127	R1124NC20L	129	R1700MC18J	130
N4316MK040	122	P0515WC04C	127	R1124NC20M	129	R1700MC21E	130
N4316MK060	122	P0515WC04D	127	R1124NC21J	129	R1700MC21F	130
➤ N4340TE180	123	P0515WC06B	127	R1124NC21K	129	R1700MC21G	130
➤ N4340TE220	123	P0515WC06C	127	R1124NC21L	129	R1700MC21H	130
➤ N4340TJ180	123	P0515WC06D	127	R1124NC21M	129	R1700MC21J	130
➤ N4340TJ220	123	P0838LC06B	127	R1127NC32P	129	R2475ZC28M	130
N4472HK160	123	P0838LC06C	127	R1127NC32R	129	R2475ZC28N	130
N4472HK180	123	P0848YS04B	127	R1127NC32S	129	R2475ZC28R	130
N4803FC300	123	P0848YS04C	127	R1127NC32T	129	R2475ZD28M	130
N4803FC350	123	P0848YS06B	127	R1127NC34R	129	R2475ZD28N	130
N4803FD300	123	P0848YS06C	127	R1127NC34S	129	R2475ZD28R	130
N4803FD350	123	P1007LC08D	127	R1127NC34T	129	R2619ZC18J	130
N5177FC200	123	P1007LC08E	127	R1127NC36R	129	R2619ZC18K	130
N5177FC280	123	P1007LC08F	127	R1127NC36S	129	R2619ZC18L	130
N5177FD200	123	P1007LC12D	127	R1127NC36T	129	R2619ZC20J	130
N5177FD280	123	P1007LC12E	127	R1158NC26N	129	R2619ZC20K	131
N5946FC180	123	P1007LC12F	127	R1158NC26P	129	R2619ZC20L	131
N5946FC220	123	R0472YS12E	128	R1158NC26T	129	R2619ZC21J	131
N5946FD180	123	R0472YS12F	128	R1178NC14E	129	R2619ZC21K	131
N5946FD220	123	R0472YS16E	128	R1178NC14F	129	R2619ZC21L	131
N6012ZD020	123	R0472YS16F	128	R1178NC14G	129	R2619ZC25J	131
N6012ZD040	123	R0487YS12D	128	R1211NC12C	129	R2619ZC25K	131
N6012ZD060	123	R0487YS12E	128	R1211NC12D	129	R2619ZC25L	131
N6974HK020	123	R0487YS14D	128	R1211NC12E	129	R2619ZD18J	131
N6974HK040	123	R0487YS14E	128	R1271NC12B	129	R2619ZD18K	131
N6974HK060	123	R0577YS12C	128	R1271NC12C	129	R2619ZD18L	131
P0128SH10C	126	R0577YS12D	128	R1271NC12D	129	R2619ZD20J	131
P0128SH10D	126	R0577YS12E	128	R1271NC12E	129	R2619ZD20K	131
P0128SH10E	126	R0633YS12D	128	R1275NC18J	129	R2619ZD20L	131
P0128SH12C	126	R0633YS12E	128	R1275NC18K	129	R2619ZD21J	131
P0128SH12D	126	R0633YS12F	128	R1275NC18L	129	R2619ZD21K	131
P0128SH12E	126	R0717LC14G	128	R1275NC18M	129	R2619ZD21L	131
P0128SJ10C	126	➤ R0717LC18G	128	R1275NC20J	129	R2619ZD25J	131
P0128SJ10D	126	R0736LC20J	128	R1275NC20K	129	R2619ZD25K	131
P0128SJ10E	126	R0736LC20K	128	R1275NC20L	129	R2619ZD25L	131
P0128SJ12C	126	R0736LC22J	128	R1275NC20M	129	R2620ZC22J	131
P0128SJ12E	126	R0736LC22K	128	R1275NC21J	129	R2620ZC22K	131
P0248SC12D	126	R0736LC25J	128	R1275NC21K	129	R2620ZC22L	131
P0248SC12E	126	R0736LC25K	128	R1275NC21L	129	R2620ZC25J	131
P0273SC12D	126	R0736LC25L	128	R1275NC21M	129	R2620ZC25K	131
P0273SC12E	126	R0736LC25M	128	R1279NC22J	129	R2620ZC25L	131
P0273SC12F	126	R0809LC10A	128	R1279NC22K	129	R2620ZD22J	131
P0295WC12D	127	R0809LC10B	128	R1279NC22L	129	R2620ZD22K	131
P0295WC12E	127	R0830LC12C	128	R1279NC22M	129	R2620ZD22L	131
P0306SC08A	126	R0830LC12D	128	R1279NC25J	129	R2620ZD25J	131
P0306SC08B	126	R0830LC12E	128	R1279NC25K	129	R2620ZD25K	131
P0306SC08C	126	R0830LC12F	128	R1279NC25L	130	R2620ZD25L	131
P0311SC12E	126	R0830LC14C	128	R1279NC25M	130	R2714ZC14H	131
P0311SC12F	126	R0830LC14D	128	R1280NC21J	130	R2714ZC14J	131
P0327WC08C	127	R0830LC14E	128	R1280NC21K	130	R2714ZC14K	131
P0327WC08D	127	R0830LC14F	128	R1280NC21L	130	R2714ZC18H	131
P0327WC08E	127	R0878LC18K	128	R1280NC21M	130	R2714ZC18J	131
P0327WC08F	127	R0878LC18L	128	R1280NC22J	130	R2714ZC18K	131
P0327WC12C	127	R0878LC18M	128	R1280NC22K	130	R2714ZD14H	131
P0327WC12D	127	R0878LC20K	128	R1280NC22L	130	R2714ZD14J	131
P0327WC12E	127	R0878LC20L	128	R1280NC22M	130	R2714ZD14K	131
P0327WC12F	127	R0878LC20M	128	R1280NC25J	130	R2714ZD18H	131
P0330SC04A	126	R0878LC21K	128	R1280NC25K	130	R2714ZD18J	131
P0330SC04C	126	R0878LC21L	128	R1280NC25L	130	R2714ZD18K	131
P0330SC06A	126	R0878LC21M	128	R1280NC25M	130	R3047TC24K	131
P0330SC06C	126	R0929LC10A	128	R1331NC10B	130	R3047TC24L	131
P0330SC08A	126	R0929LC10B	128	R1331NC10C	130	R3047TC24M	131
P0330SC08C	126	R0929LC10C	128	R1331NC10D	130	R3047TC24N	131
P0366WC04A	127	R0929LC12A	128	R1331NC12B	130	R3047TC28K	131
P0366WC04B	127	R0929LC12B	128	R1331NC12C	130	R3047TC28L	131
P0366WC04C	127	R0929LC12C	128	R1331NC12D	130	R3047TC28M	131
P0366WC06A	127	R0929LC12D	128	R1446NC12C	130	R3047TC28N	131
P0366WC06B	127	R0929LC12E	128	R1446NC12E	130	R3047TD24K	132
P0366WC06C	127	R0964LC10C	128	R1446NC12F	130	R3047TD24L	132
P0366WC08A	127	R0964LC10D	128	R1446NC12G	130	R3047TD24M	132
		R0964LC10E	128	R1448NC14H	130		

# Alphanumeric Index

- New
- Not for new design
- ✦ Under development

R3047TD24N	132	SXB5877HEX	143	W1263YH160	109	W3841VC300	110
R3047TD28K	132	SXB5993G	143	W1263YH200	109	W3841VC340	110
R3047TD28L	132	SXB6240HEXT	143	W1263YH250	109	W3841VF300	110
R3047TD28M	132	SXB868FB	143	W1411LC300	109	W3841VF340	110
R3047TD28N	132	SXB9737HEX	143	W1411LC360	109	W3842MC240	110
R3370ZC12C	132	SXC1076FB	146	W1411LC360KBN	155	W3842MC280	110
R3370ZC12D	132	SXC1195FR	146	W1411LC360KBR	155	W3842MC28KDN	155
R3370ZC12E	132	SXC1318FB	146	W1411LC360KCN	155	W3842MC28KDR	155
R3370ZD12C	132	SXC1464FR	146	W1411LC360KCR	155	W3864QK120	110
R3370ZD12D	132	SXC1517FG	146	W1520NC500	109	W3864QK150	110
R3370ZD12E	132	SXC1609FB	146	W1520NC600	109	W3864QK180	110
R3559TC16K	132	SXC1788FR	146	W1524LC240	109	W4096ZC340	110
R3559TC16M	132	SXC1871FG	146	W1524LC300	109	W4096ZC450	110
R3559TC16N	132	SXC2319FG	146	W1524LC300KBN	155	W4096ZD340	110
R3559TC20K	132	SXF30xxxxAN	152	W1524LC300KBR	155	W4096ZD450	110
R3559TC20M	132	SXF46xxxxAN	152	W1524LC300KCN	155	W4534NC020	110
R3559TC20N	132	SXFLPxxxxAN	152	W1524LC300KCR	155	W4534NC060	110
R3559TD16K	132	T0160NB45A	135	W1748LC180	109	W4693QK050	110
R3559TD16M	132	T0240NB45E	135	W1748LC220	109	W4693QK080	110
R3559TD16N	132	T0340VB45G	135	W1748LC220KBN	155	W4693QR050	110
R3559TD20K	132	T0360NB25A	135	W1748LC220KBR	155	W4693QR080	110
R3559TD20M	132	T0500NB25E	135	W1748LC220KCN	155	W4713HL300	110
R3559TD20N	132	T0510VB45E	135	W1748LC220KCR	155	W4713HL350	110
R3636EC16K	132	T0570VB25G	135	W1748LC250	109	W4713HM300	110
R3636EC16M	132	T0600TB45A	135	○ W1856NC400	109	W4713HM350	110
R3636EC16N	132	T0800EB45G	135	○ W1856NC500	109	W4767MC180	110
R3636EC20K	132	T0800TB45E	135	W2054NC360	109	W4767MC220	110
R3636EC20M	132	T0850VB25E	135	W2054NC450	109	W5092ZC320	110
R3636EC20N	132	T0900EB45A	135	W2058LC100	109	W5092ZC350	110
R3708FC45V	132	T1200EB45E	135	W2058LC120	109	W5092ZD320	110
R3708FC45W	132	T1200TB25A	135	W2058LC120KBN	155	W5092ZD350	110
R3708FD45V	132	T1500TB25E	135	W2058LC120KBR	155	➤ W5130MK240	110
R3708FD45W	132	T1600GB45G	135	W2058LC120KCN	155	➤ W5130MK280	110
R3968FC24K	132	T1800GB45A	135	W2058LC120KCR	155	➤ W5139TE400	111
R3968FC24M	132	T2250AB25E	135	W2058LC140	109	➤ W5139TE480	111
R3968FC24N	132	T2400GB45E	135	W2115MC520	109	➤ W5139TJ400	111
R3968FC28K	132	W0428RE250	108	W2115MC560	109	➤ W5139TJ480	111
R3968FC28M	132	W0428RE280	108	W2115MC600	109	W5282ZC240	111
R3968FC28N	132	W0428RE320	108	W2134NC300	109	W5282ZC300	111
R3968FD24K	132	W0428RF250	108	W2134NC400	109	W5282ZD240	111
R3968FD24M	132	W0428RF280	108	○ W2624NC200	109	W5282ZD300	111
R3968FD24N	132	W0428RF320	108	○ W2624NC250	109	○ W5292TC500	111
R3968FD28K	132	W0428SE250	108	W2820VC360	109	○ W5292TC560	111
R3968FD28M	132	W0428SE280	108	W2820VC450	109	○ W5292TD500	111
R3968FD28N	132	W0428SE320	108	W2820VF360	109	○ W5292TD560	111
S0300SR12D	134	W0428SF250	108	W2820VF450	109	W5334MK200	111
S0300SR12Y	134	W0428SF280	108	W2899MC420	109	W5334MK220	111
S0500KC200	134	W0428SF320	108	W2899MC460	109	W5636MC120	111
S0500KC20Y	134	W0503RC160	108	W2899MC480	109	W5636MC140	111
S0500KC25D	134	W0503RC200	108	W3082MC420	109	W5636MC150	111
S0500KC25Y	134	W0503RC240	108	W3082MC440	109	W5636MC15KDN	155
➤ S0500YC20Y	134	W0503SC160	108	W3082MC450	109	W5636MC15KDR	155
➤ S0500YC25Y	134	W0503SC200	108	W3082MC45KDN	155	W5696VC100	111
S0700KC140	134	W0503SC240	108	W3082MC45KDR	155	W5696VC140	111
S0700KC14Y	134	W0507YH360	109	W3128VC300	110	W5696VF100	111
S0700KC17D	134	W0507YH450	109	W3128VC400	110	W5696VF140	111
S0700KC17Y	134	W0642WC160	109	W3128VF300	110	W5838ZC180	111
S1000NC300	134	W0642WC200	109	W3128VF400	110	W5838ZC220	111
S1000NC30Y	134	W0642WC240	109	W3270NC200	110	W5838ZD180	111
S1000NC36D	134	W0735RA120	108	W3270NC20A	110	W5838ZD220	111
S1000NC36Y	134	W0735RA150	108	W3270NC220	110	➤ W5984TE360	111
S1200NC200	134	W0735SA120	108	W3270NC22A	110	➤ W5984TE400	111
S1200NC20Y	134	W0735SA150	108	➤ W3305QK240	110	➤ W5984TJ360	111
S1200NC25D	134	W0944WC120	109	➤ W3305QK280	110	➤ W5984TJ400	111
S1200NC25Y	134	W0944WC150	109	W3455QK200	110	W6262ZC200	111
SXB11987HEX	143	W1032LC500	109	W3455QK220	110	W6262ZC240	111
SXB1214FG	143	W1032LC560	109	W3477MC360	110	W6262ZD200	111
SXB1265FB	143	W1032LC600	109	W3477MC380	110	W6262ZD240	111
SXB1375B	143	W1074YC200	109	W3477MC400	110	W6908FC450	111
SXB1645FB	143	W1074YC260	109	W3697VC220	110	W6908FC500	111
SXB1764FG	143	W1074YC320	109	W3697VC280	110	W6908FD450	111
SXB1920G	143	W1074YH200	109	W3697VF220	110	W6908FD500	111
SXB2096B	143	W1074YH260	109	W3697VF280	110	W7045MC030	111
SXB2167FB	143	W1074YH320	109	W3708MC300	110	W7045MC060	111
SXB2324FG	143	W1185LC300	109	W3708MC320	110	W8405ZC100	111
SXB2428HEXT	143	W1185LC380	109	W3708MC350	110	W8405ZC140	111
SXB2939G	143	W1185LC450	109	W3708MC35KDN	155	W8405ZD100	111
SXB3120FG	143	W1185LC450KBN	155	W3708MC35KDR	155	W8405ZD140	111
SXB3442B	143	W1185LC450KBR	155	W3743ZC400	110	➤ W8570TE180	111
SXB3529HEXT	143	W1185LC450KCN	155	W3743ZC450	110	➤ W8570TE220	111
SXB3840HEX	143	W1185LC450KCR	155	W3743ZC500	110	➤ W8570TJ180	111
SXB4264B	143	W1263YC160	109	W3743ZD400	110	➤ W8570TJ220	111
SXB4649HEXT	143	W1263YC200	109	W3743ZD450	110	➤ W9830TE120	111
SXB4869G	143	W1263YC250	109	W3743ZD500	110	➤ W9830TE150	111



# Alphanumeric Index

- New
- Not for new design
- ✦ Under development

➤ W9830TJ120	111	XSK####DA065Mxxx	150	XW180GC34B	153	XSNM10H15P	145
➤ W9830TJ150	111	XSK####DA075Mxxx	150	XW180GN25A	153	XSNM12H10S	145
XK0450BA019M	152	XSK####DA087Mxxx	150	XW270QA25A	153	XSNM12H12S	145
XK0450BA025M	152	XSK####DA103Mxxx	150	Y200CKC250	133	➤ XST1000M08P	141
XK0450BB019M	152	XSK####DA112Mxxx	150	Y500CNC250	133	➤ XST1000M10P	141
XK0450BB025M	152	XSK####DA120Mxxx	150	XK1130DA076M	142	➤ XST1000M12P	141
XK0450DA056M	148	XSK####DA126Mxxx	150	XK1130DT076M	142	➤ XST1000M16P	141
XK0450DT056M	148	XSK####DF042Mxxx	150	XK1130SA076M	142	XW076NC16A	145
XK0450SA056M	148	XSK####DF054Mxxx	150	➤ XK1500BA034M	143	XW076NC16B	145
XK0550DA056M	148	XSK####DF056Mxxx	150	XK1800DA076M	142	XW076NC16BS	145
XK0550SA056M	148	XSK####DF065Mxxx	150	XK1800DT076M	142	XW076NC16BT	145
XK0600DA074M	148	XSK####DF075Mxxx	150	XK1800SA076M	142	XW076NC16C	145
XK0600SA074M	148	XSK####DF087Mxxx	150	XK2000DA114M	142	XW076NC16CT	145
○ XK0900DA056M	148	XSK####DF103Mxxx	150	XK2000SA114M	142	XW076NC16R	145
○ XK0900DT056M	148	XSK####DF112Mxxx	150	XK2100DA076M	142	XW076NC16W	145
XK0900SA056M	148	XSK####DF120Mxxx	150	XK2100DA076ML	142	XW116ZC20A	145
XK1000DA074M	148	XSK####DF126Mxxx	150	XK2100SA076M	142	XW116ZC20B	145
XK1000SA074M	148	XSK####DT042Mxxx	150	XK2100SA076ML	142	XW116ZC20C	145
XK1100DA076M	148	XSK####DT054Mxxx	150	XK2140DA076M	142	XW116ZC20R	145
XK1130DA076M	148	XSK####DT056Mxxx	150	XK2140DA076ML	142	XW116ZC20W	145
XK1130DT076M	148	XSK####DT065Mxxx	150	XK2140DT076M	142	➤ XW127EA25A	145
XK1130SA076M	148	XSK####DT075Mxxx	150	XK2140DT076ML	142	➤ XW127EA25B	145
XK1130SB076M	155	XSK####DT087Mxxx	150	XK2140SA076M	142	➤ XW127EC25A	145
XK1500BA034M	152	XSK1500DA076038	151	XK2140SA076ML	142	➤ XW127EC25B	145
XK1500CB034M	155	XSK1500DA076076	151	XK2500DA114M	142	XW127EN15A	145
XK1800DA076M	148	XSK1500DA076101	151	XK2500DA116M	142	XW127EN15B	145
XK1800DT076M	148	XSK2000DA076038	151	XK2500DA116ML	142	XW160FC25A	145
XK1800SA076M	148	XSK2000DA076076	151	XK2500SA114M	142	XW160FC25B	145
XK2000DA114M	148	XSK2000DA076101	151	XK2500SA116M	142	➤ XW180GA34A	145
XK2000SA114M	148	XSK3000DA076038	151	XK2500SA116ML	142	➤ XW180GA34B	145
XK2100DA076M	148	XSK3000DA076076	151	XK2700DA076M	142	XW180GC34A	145
XK2100DA076ML	148	XSK3000DA076101	151	XK2700DT076M	142	➤ XW180GC34B	145
XK2100SA076M	148	XSK3400DA076038	151	XK2700SA076M	142	➤ XW180GN25A	145
XK2100SA076ML	148	XSK3400DA076076	151	XK3000DA116M	142	XW270QA25A	145
○ XK2140DA076M	148	XSK3400DA076101	151	XK3000DA116ML	142		
○ XK2140DA076ML	148	XSK3800DA116M076	151	XK3000SA116M	142		
○ XK2140DT076M	148	XSK3800DA116M101	151	XK3000SA116ML	142		
○ XK2140DT076ML	148	XSK4400DA116M076	151	XK3060DA140ML	143		
XK2140SA076M	148	XSK4400DA116M101	151	XK3060SA140ML	143		
XK2140SA076ML	148	XSK6000DA116M076	151	XK3500DA116M	142		
XK2140SB076M	155	XSK6000DA116M101	151	XK3500DA116ML	142		
XK2500DA114M	148	XSL1000C2WRP	147	XK3500SA116M	142		
XK2500DA116M	148	XSL1000C2WRT	147	XK3500SA116ML	142		
XK2500SA114M	148	XSL1100C2WRT	147	XK4000DA116M	142		
XK2500SA116M	148	XSL200D8WRC	147	XK4000DA116ML	142		
XK2500SA116ML	148	XSL200D8WRCP	147	XK4000SA116M	142		
XK2700DA076M	148	XSL220C2WRT	147	XK4000SA116ML	142		
XK2700DT076M	148	XSL300C2WRP	147	XK5000DA128M	143		
XK2700SA076M	148	XSL300C2WS	147	XK5000DA128ML	143		
○ XK3000DA116M	148	XSL350C2WRP	147	XK6120DA180ML	143		
○ XK3000DA116Mx	148	XSL400C2WRP	147	XK6120SA180ML	143		
XK3000SA116M	148	XSL500C2WRP	147	XK7000DA128M	143		
XK3060DA140ML	149	XSL600C2WRP	147	XK7000DA128ML	143		
XK3060SA140ML	149	XSNM10H15P	153	XK9000DA160M	143		
XK3500DA116M	148	XSNM12H10S	153	XK9000DA160ML	143		
XK3500DA116ML	148	XSNM12H12S	153	XK9000SA160M	143		
XK3500SA116M	148	XST1000M08P	147	XK9000SA160ML	143		
XK3500SA116ML	148	XST1000M10P	147	XSFgAxxxxAN	146		
○ XK4000DA116M	148	XST1000M12P	147	XSFgxxxxAN	146		
○ XK4000DA116ML	148	XST1000M16P	147	XSFHxxxxAN	146		
XK4000SA116M	148	XW076NC16A	153	XSFHxxxxAN	146		
XK4000SA116ML	148	XW076NC16B	153	XSFTBxxxxAN	146		
XK5000DA128M	149	XW076NC16BS	153	XSFTCxxxxAN	146		
XK5000DA128ML	149	XW076NC16BT	153	XSFTxxxxAN	146		
XK6120DA180ML	149	XW076NC16C	153	➤ XSGSCX13	141		
XK6120SA180ML	149	XW076NC16CT	153	XSK1500DA076xxx	144		
XK7000DA128M	149	XW076NC16R	153	XSK1500DA076xxx	144		
XK7000DA128ML	149	XW076NC16S	153	XSK1500DA076xxx	144		
XK9000DA160M	149	XW076NC16W	153	XSK2000DA076xxx	144		
XK9000DA160ML	149	XW116ZC20A	153	XSK2000DA076xxx	144		
XK9000SA160M	149	XW116ZC20B	153	XSK2000DA076xxx	144		
XK9000SA160ML	149	XW116ZC20C	153	XSK3000DA076xxx	144		
XSFgAxxxxAN	152	XW116ZC20R	153	XSK3000DA076xxx	144		
XSFgxxxxAN	152	XW116ZC20W	153	XSK3400DA076xxx	144		
XSFHxxxxAN	152	XW127EA25A	153	XSK3400DA076xxx	144		
XSFTBxxxxAN	152	XW127EA25B	153	XSK3800DA116Mxxx	144		
XSFTCxxxxAN	152	XW127EC25A	153	XSK3800DA116Mxxx	144		
XSFTxxxxAN	152	XW127EC25B	153	XSK4400DA116Mxxx	144		
XSGSCX13	147	XW127EN15A	153	XSK4400DA116Mxxx	144		
XSK####DA042Mxxx	150	XW127EN15B	153	XSK6000DA116Mxxx	144		
XSK####DA054Mxxx	150	XW160FC25A	153	XSK6000DA116Mxxx	144		
XSK####DA056Mxxx	150	XW160FC25B	153	➤ XSL1000C2WRP	141		
		XW180GA34A	153	➤ XSL300C2WRP	141		
		XW180GA34B	153				
		XW180GC34A	153				

# Symbols and Terms

<b>a</b>	Acceleration	$I_{FM}$	Maximum forward current
$BV_{CES}$	Collector emitter breakdown voltage	$I_{FAV}$	Average forward current
$BV_{DSS}$	Drain source breakdown voltage	$I_{F(AV)M}, I_{T(AV)M}$	Maximum average forward current
$C_{ies}, C_{iss}$	Input capacitance	$I_{FLT}$	Sink current of fault terminal
$C_{oes}, C_{oss}$	Output capacitance	$I_{FRM}$	Maximum repetitive forward current
$C_{res}, C_{rss}$	Reverse transfer (Miller) capacitance	$I_{F(RMS)}, I_{T(RMS)}$	RMS forward current
<b>d</b>	Duty cycle	$I_{FSM}, I_{TSM}$	Maximum surge forward current
$d_A$	Strike distance through air	$I_G, I_{GT}$	Trigger gate current
$di/dt, -di/dt$	Rate of change of current	$I_{GD}$	Non-trigger gate current
$(di/dt)_{cr}$	Critical rate of rise of current	$I_{GES}$	Gate emitter leakage current
$di_F/dt, -di_F/dt$	Rate of change of forward current	$I_H$	Holding current
$d_s$	Creep distance on surface	$I_{IN(H)}$	Signal input current (high level)
$dv/dt$	Rate of rise of voltage	$I_{IN(L)}$	Signal input current (low level)
$(dv/dt)_{cr}$	Critical rate of rise of voltage	$I_{ISOL}$	RMS current for isolation test
$E_{AR}$	Repetitive avalanche energy	$I_L$	Latching current
$E_{AS}$	Non-repetitive avalanche energy	$I_R$	Reverse current
$E_{off}$	Turn-off energy per pulse	$I_{RM}$	Maximum reverse recovery current
$E_{on}$	Turn-on energy per pulse	$I_{RMS}$	RMS current
$E_{rec(off)}$	Reverse recovery losses at turn-off	$I_{RRM}$	Maximum repetitive reverse current
$F_{(mounting)}$	Required force to mount hole-less discretes on heat sink	$I_S$	Continuous source current
$g_{fs}$	Forward transconductance	$I_{SM}$	Maximum pulsed source current
$I_{AR}$	Repetitive avalanche current	$I^2t$	$I^2t$ value for fusing
$I_{AVM}$	Maximum average forward current	$I_{TSM}$	Maximum surge on-state current
$I_{BO}$	Breakover current	$K_f$	Characteristic factor
$I_{C(on)}$	Short circuit current	$K_p$	Coeff. for energy per pulse $E_p$ (material constant)
$I_C$	Collector current	$K_T$	Temperature coefficient of VBO
$I_{C25}$	Continuous DC collector current at $T_C = 25^\circ C$	<b>L</b>	Series stray inductance
$I_{C90}$	Continuous DC collector current at $T_C = 90^\circ C$	<b>M<sub>d</sub></b>	Mounting torque
$I_{CES}$	Collector emitter leakage current	<b>P<sub>C</sub></b>	Collector power dissipation
$I_{CM}$	Maximum pulsed collector current	<b>P<sub>D</sub></b>	Power dissipation
$I_D$	Drain current	<b>P<sub>GAV</sub></b>	Average gate power dissipation
$I_{DD}$	Module supply current, operating mode	<b>P<sub>G(AV)M</sub></b>	Maximum average gate power dissipation
$I_{DD0}$	Module supply current, standby mode	<b>P<sub>GM</sub></b>	Maximum gate power dissipation
$I_{D(cont)}$	Continuous drain current	<b>P<sub>RSM</sub></b>	Maximum surge reverse power dissipation
$I_{D25}$	Continuous drain current at $T_C = 25^\circ C$	<b>P<sub>T}, P_{tot}</sub></b>	Total power dissipation
$I_{DAV}$	Average DC output current	<b>Q<sub>g</sub></b>	Total gate charge
$I_{D(AV)M}$	Maximum average DC output current	<b>Q<sub>gc</sub></b>	Gate collector (Miller) charge
$I_{DM}$	Maximum pulsed drain current	<b>Q<sub>gd</sub></b>	Gate drain (Miller) charge
$I_{DRM}$	Maximum repetitive off-state current	<b>Q<sub>ge</sub></b>	Gate emitter charge
$I_{D(RMS)}$	RMS output current	<b>Q<sub>gs</sub></b>	Gate source charge
$I_{DSS}$	Drain source leakage current	<b>Q<sub>r</sub></b>	Reverse recovery charge
$I_F, I_T$	Forward current	<b>Q<sub>RM</sub></b>	Reverse recovery charge (intrinsic diode)
		<b>Q<sub>S</sub></b>	Recovered charge to IRM

<b>RBSOA</b>	Reverse Bias Safe Operating Area	<b>V<sub>DSM</sub></b>	Max. non-repetitive forward blocking voltage
<b>R<sub>DS(on)</sub></b>	Static drain source on resistance	<b>V<sub>DSS</sub></b>	Drain source breakdown voltage
<b>R<sub>FI</sub></b>	Radio frequency interference (= EMI)	<b>Version</b>	Various construction designs of products
<b>R<sub>G</sub></b>	Gate resistance	<b>V<sub>F</sub></b>	Forward voltage
<b>R<sub>GE</sub></b>	Gate emitter resistance	<b>V<sub>FLT</sub></b>	Voltage at fault terminal
<b>rT</b>	Slope resistance (for power loss calculation only)	<b>V<sub>FR</sub></b>	Forward recovery voltage
<b>R<sub>thCK</sub>; R<sub>thCH</sub></b>	Thermal resistance case to heatsink	<b>V<sub>GD</sub></b>	Gate non-trigger voltage
<b>R<sub>thJA</sub></b>	Thermal resistance junction to ambient	<b>V<sub>GE</sub></b>	Gate emitter voltage
<b>R<sub>thJC</sub></b>	Thermal resistance junction to case	<b>V<sub>GE(th)</sub></b>	Gate emitter threshold voltage
<b>R<sub>thJK</sub>; R<sub>thJH</sub></b>	Thermal resistance junction to heatsink	<b>V<sub>GEM</sub></b>	Maximum transient collector gate voltage
<b>R<sub>thJS</sub></b>	Thermal resistance junction to heatsink	<b>V<sub>GES</sub></b>	Maximum DC gate voltage
<b>R<sub>thJW</sub></b>	Thermal resistance junction to water	<b>V<sub>GS</sub></b>	Gate source voltage
<b>R<sub>thKA</sub></b>	Thermal resistance heatsink to ambient	<b>V<sub>GS(th)</sub></b>	Gate threshold voltage
<b>SCSOA</b>	Short Circuit Safe Operating Area	<b>V<sub>GSM</sub></b>	Maximum transient gate source voltage
<b>T<sub>amb</sub>; T<sub>A</sub></b>	Ambient (cooling medium) temperature	<b>V<sub>GT</sub></b>	Gate trigger voltage
<b>T<sub>C</sub>; T<sub>case</sub></b>	Case temperature	<b>V<sub>H</sub></b>	Holding voltage
<b>t<sub>d(off)</sub></b>	Turn-off delay time	<b>V<sub>IN</sub></b>	Input control voltage
<b>t<sub>d(on)</sub></b>	Turn-on delay time	<b>V<sub>IN(H)</sub></b>	Input voltage threshold for IGBT turn-on
<b>t<sub>fi</sub></b>	Current fall time (inductive load)	<b>V<sub>IN(L)</sub></b>	Input voltage threshold for IGBT turn-off
<b>t<sub>fr</sub></b>	Forward recovery time	<b>V<sub>ISOL</sub></b>	Isolation voltage
<b>t<sub>FLT</sub></b>	Overcurrent or short circuit trip delay time	<b>V<sub>R</sub></b>	Reverse voltage
<b>t<sub>gd</sub></b>	Gate controlled delay time	<b>V<sub>RES</sub></b>	Input voltage threshold for Reset = active
<b>T<sub>J</sub>; T<sub>VJ</sub></b>	Virtual junction temperature	<b>V<sub>RGM</sub></b>	Maximum reverse gate voltage
<b>T<sub>JM</sub>; T<sub>VJM</sub></b>	Maximum virtual junction temperature	<b>V<sub>RRM</sub></b>	Maximum repetitive reverse voltage
<b>T<sub>K</sub>; T<sub>H</sub>; T<sub>S</sub></b>	Heatsink temperature	<b>V<sub>RSM</sub></b>	Maximum non-repetitive reverse voltage
<b>T<sub>L</sub></b>	Lead temperature	<b>VSD</b>	Forward voltage drop
<b>T<sub>S(max)</sub></b>	Maximum allowable heatsink temperature	<b>V<sub>T</sub></b>	Forward voltage
<b>T<sub>stg</sub></b>	Storage temperature	<b>V<sub>TO</sub></b>	Threshold voltage (for power loss calculation)
<b>t<sub>p</sub></b>	Pulse time	<b>Z<sub>thJC</sub></b>	Transient thermal impedance junction to case
<b>t<sub>q</sub></b>	Turn-off time	<b>Z<sub>thJK</sub>; Z<sub>thJH</sub></b>	Transient thermal impedance junction to heatsink
<b>t<sub>r</sub></b>	Current rise time		
<b>t<sub>rr</sub></b>	Reverse recovery time		
<b>t<sub>rv</sub></b>	Rise time of collector emitter voltage		
<b>t<sub>SC</sub></b>	Short circuit duration		
<b>V<sub>BO</sub></b>	Breakover voltage		
<b>V<sub>CE</sub></b>	Collector emitter voltage		
<b>V<sub>CE(sat)</sub></b>	Collector emitter saturation voltage		
<b>V<sub>CE(sat)FLT</sub></b>	Collector emitter saturation voltage to indicate fault		
<b>V<sub>CEK</sub></b>	Collector emitter clamp voltage on chip level		
<b>V<sub>CES</sub></b>	Collector emitter voltage		
<b>V<sub>CGR</sub></b>	Collector gate voltage		
<b>V<sub>DD</sub></b>	Module supply voltage		
<b>V<sub>DD FLT</sub></b>	Module supply voltage without fault		
<b>V<sub>DGR</sub></b>	Drain gate voltage		
<b>V<sub>DRM</sub></b>	Maximum repetitive forward blocking voltage		
<b>V<sub>DS</sub></b>	Drain source voltage		

## Semiconductor Catalog, Edition 2013

© IXYS Corporation 2013  
All Rights reserved

### Note

As far as patents or other rights of third parties are concerned, liability is only assumed for components per se, not for applications, processes and circuits implemented with components or assemblies. The information describes the type of component and shall not be considered as assured characteristics.

Stress above one or more of the limiting values may cause permanent damage to the device. These are stress ratings only and operation of the device at these or at any other conditions above those given in the characteristics sections of the specification is not implied. Exposure to limiting values for extended periods may affect device reliability. Terms of delivery and rights to change design or specifications are reserved. Changes have been made to earlier published specifications. The data herein supersedes all previously published informations.

### Life support applications

IXYS products used in life support appliances, devices, or systems where malfunction of these products can reasonably be expected to result in personal injury must be expressly authorized for such purposes.

## CAPSULE DEVICES

W	0646	W	C	15	0
W					
M					
F					
E					
N					
R					
P					
K					
A					
S					
H					
G					
Y					
	0646				
		W			
		Y			
		K			
		J			
		L			
		Q			
		N			
		M			
		P			
		V			
		H			
		Z			
		T			
		E			
		F			
		G			
			A		
			C		
			D		
			E		
			F		
			G		
			H		
			J		
			K		
			L		
			M		
			R		
				15	
					0

(Sample)

**Device Type**

- Rectifier diode
- Fast/soft recovery diode
- Extra fast diode
- HP Sonic-FRD™
- Phase control thyristor
- Distributed gate thyristor
- Fast turn-off thyristor
- Medium voltage thyristor
- Asymmetric thyristor
- Symmetrical Gate Turn-off thyristor
- Fast Symmetrical Gate Turn-off thyristors
- Asymmetric Gate Turn-off thyristors
- Pulse Thyristors

**Device nominal current rating**

\* For devices exceeding 9999 amperes, digit 5 of the part number changes to C (x10)

**Electrode diameter**

- 19 mm
- 25 mm
- 29 mm
- 32 mm
- 34 mm
- 38 mm
- 47 mm
- 50 mm
- 57 mm
- 63 mm
- 66 mm / 68 mm
- 73 mm
- 75 mm
- 85 mm
- 99 mm
- 125 mm

tq Code			
0	No code		
A	10	M	70
B	12	N	100
C	15	P	120
D	20	R	140
E	25	S	160
F	30	T	200
G	35	V	250
H	40	W	300
J	50	X	400
K	60	Y	500
L	65	Z	1000

**Housing Type (electrode diameter in brackets)**

- 26 mm reverse build
- Standard outline 14 mm (W, Y) 16 mm (K) 26 mm (L, Q, M, T, E) 26.5 mm (N)  
33 mm (V) 36 mm (F, G) 37 mm (Z)
- 21 mm (N), 24 mm (V, Z), Thick pack 26 mm (Z, F, G)
- 35 mm inverse build (T, M, Q)
- 19.5 mm (L), 26 mm (K, N, V), 35 mm (Z)
- 35 mm (L, N)
- 14 mm (N), 26 mm (Y), slotted 32 mm (V)
- 19.5 mm (N), 25.8 mm (V)
- Wespack 14.5 mm (J, Q, M, H)
- Wespack 26 mm (Q, M)
- Wespack 33 mm (H)
- Wespack 14 mm (Q), 26 mm (N)

V <sub>RRM</sub> % of V <sub>DRM</sub> for GTO's (S and H types only)	
0	100
D	80
Y	100 V

**Voltage grade** =  $V_{RRM} / V_{DRM} \div 100$

**0** *t<sub>q</sub> code for fast thyristors or V<sub>RRM</sub> % of V<sub>DRM</sub> for GTO thyristors*

- P PIN diode (Device Types: W, M, F and E)
- R Rotating Package (N, K, W)
- A Avalanche rated diode (W)

## STUD DEVICES

<p>W M N P S</p> <p>0508</p> <p>S R</p> <p>A C E F H J L M R</p> <p>04</p> <p>0</p>	<p>(Sample)</p> <p><b>Device type</b> Rectifier diode Fast/soft recovery diode Phase control thyristor Fast turn-off thyristor Symmetrical Gate turn-off thyristor</p> <p><b>Device nominal current rating</b></p> <p><b>Polarity</b> Normal Reverse (diode only)</p> <p><b>Package</b> ¾" stud glass/metal ¾" stud ceramic ¾" HV ceramic stud with lug ¾" HV ceramic stud ½" stud ceramic ½" stud ceramic with flag M12 stud ceramic with lug ¾" stud ceramic M20 stud ceramic with leg &amp; lgate leads</p> <p><b>Voltage grade</b> = <math>V_{RRM} / V_{DRM} \div 100</math></p> <p><b>tq code</b> 0 No code A 10 B 12 C 15 D 20 E 25 F 30 G 35 H 40 J 50 K 60 L 65 M 70 N 100 P 120 R 140 S 160 T 200 V 250 W 300 X 400 Y 500 Z 1000</p>
---	---

## PRESS-PACK IGBT CAPSULE DEVICES

<p>T T</p> <p>0240</p> <p>N V T E A G</p> <p>B</p> <p>45</p> <p>E</p>	<p><b>Device type</b> Press-pack IGBT thyristor</p> <p><b>Device pulse current rating</b></p> <p><b>Pole electrode diameter</b> 47 mm 63 mm 75 mm 85 mm 96 mm 125 mm</p> <p><b>Die series</b></p> <p><b>Voltage grade</b> - <math>V_{RRM}/100</math> 45</p> <p><b>Build description for multiple square die</b> A Reverse conducting E Asymmetric G Reversing (IGBT to diode ratio of 2:1)</p>
---	--

# NEW PACKAGES

## NEW High Voltage TO-263 ( $D^2$ -Pak) and TO-268 ( $D^3$ -Pak) packages

- ✓ improved pin spacing (no middle pin)
- ✓ creepage distance pins to copper of backside:
  - 4.7 mm for new TO-263 HV package
  - 5.8 mm for new TO-268 HV package

### Products in TO-263 HV package (w/o middle pin)

BIPOLAR	Technology	Config.	$V_{RRM}$	$I_{DAV} / I_{TAV}$	@ $T_C$
➤ New			V	A	°C
➤ CMA 30E1600PZ	Thyristor	single	1600	30	115
➤ DMA 10P1600PZ	Rectifier Diode	Phase Leg	1600	10	150
➤ DNA 30E2200PZ	Rectifier Diode	Single	2200	30	140
➤ DNA 30EM2200PZ				30	140

X011c

TO-263AB



IGBT & MOSFET	Technology	Config.	$V_{CES} / V_{DSS}$	$I_{C25} / I_{D25}$	$V_{CEsat} / R_{DSon}$
➤ New			V	A	V / $\Omega$
➤ IXXA 30N65C3HV	GenX3™ XPT IGBT	Single	650	52	2.2 V
➤ IXA 12IF1200PZ	XPT IGBT	Copack	1200	20	1.8 V
➤ IXA 20I1200PZ		Single	1200	38	1.8 V
➤ IXTA 3N100D2HV	Depletion Mode MOSFET		1000	3.0	6 $\Omega$
➤ IXGA 20N250HV	High Voltage NPT IGBT		2500	30	3.1 V
➤ IXBA 12N300HV	High Voltage BIMOS		3000	30	2.8 V
➤ IXTA 02N450HV	High Voltage MOSFET		4500	0.2	750 $\Omega$

Creepage (min):

pin to pin: 4.0 mm

pin to Cu backside: 4.7 mm

for more details see outline drawings

### Products in TO-268 HV package (w/o middle pin)

BIPOLAR	Technology	Config.	$V_{RRM}$	$I_{DAV} / I_{TAV}$	@ $T_C$
➤ New			V	A	°C
➤ CLA 60MT1200NTZ	Triac	Single	1200	30	120
➤ CMA 50E1600TZ	Thyristor		1600	50	110

IGBT & MOSFET	Technology	Config.	$V_{CES} / V_{DSS}$	$I_{C25} / I_{D25}$	$V_{CEsat} / R_{DSon}$
➤ New			V	A	V / $\Omega$
➤ IXA 4IF1200TZ	XPT IGBT	Copack	1200	9	1.8 V
➤ IXYT 20N120C3D1HV	GenX3™ XPT IGBT		1200	36	4.0 V
➤ IXTT 1N250HV	High Voltage MOSFET	Single	2500	1.5	40 $\Omega$
➤ IXGT 25N250HV	High Voltage NPT IGBT		2500	60	2.9 V
➤ IXBT 12N300HV	High Voltage BIMOS		3000	30	2.8 V
➤ IXBT 20N300HV	High Voltage BIMOS		3000	50	2.7 V
➤ IXBT 42N300HV	High Voltage BIMOS		3000	104	2.5 V
➤ IXTT 02N450HV	High Voltage MOSFET		4500	0.2	750 $\Omega$
➤ IXTT 1N450HV	High Voltage MOSFET		4500	1.0	85 $\Omega$

X019a

TO-268AA



Creepage (min):

pin to pin: 9.4 mm

pin to Cu backside: 5.8 mm

for more details see outline drawings

## ISO247 ISOPLUS Technology with Screw Hole

- ✓ 3000V isolation
- ✓ Excellent thermal performance
- ✓ 100% mechanical fit to TO-247

BIPOLAR	Technology	Configuration	$V_{RRM}$	$I_{DAV} / I_{TAV}$	@ $T_C$
➤ New			V	A	°C
➤ DSA 90C200HR	Schottky Gen <sup>2</sup>	Common Cathode	200	2 x 45	140
➤ CLA 60MT1200NHR	Triac	Single	1200	30	120

IGBT	Technology	Config.	$V_{CES} / V_{DSS}$	$I_{C25} / I_{D25}$	$V_{CEsat}$
➤ New			V	A	V
➤ IXGJ 50N60C4D1	High Gain IGBT	Copack	600	52	2.5
➤ IXYJ 20N120C3D1	Gen X3 XPT IGBT		1200	21	2.5

X016c

ISO247

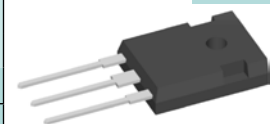

**ISOPLUS-SMPD™**

**ISOPLUS-DIL™**

**ISOPLUS i4-PAC™**

**ISOPLUS264™**

**ISO247™**

**ISOPLUS247™**

**ISOPLUS220™**

## Isolated Discrete Packages

ISOPLUS247™ is the DCB isolated version of the PLUS247™ package (TO-247 without a mounting hole). The design of this patented package is revolutionary: the silicon chip is soft soldered onto a Direct Copper Bond (DCB) substrate instead of the usual copper lead frame. The DCB ceramic, the same substrate material as used in the high power modules, not only provides high isolation capability (2500 V<sub>RMS</sub>) but also unbeatable low thermal resistance compared to conventional, externally mounted isolation materials.

### Advantages:

- Isolation capability from leads to backside 2500 V<sub>RMS</sub> – no external isolation foil needed
- Thermal resistance from Junction to Case only slightly higher as for non-isolated version
- Increased power- and temperature cycling capability
- DCB can be patterned like printed circuit boards – allowing special functions to be realized

types available.

Another interesting feature is the capability to pattern the DCB substrate like a printed circuit board. Now additional special functions can be realized, e.g. the **series connection of single** diode chips within one package.

**ISOPLUS220™, ISOPLUS247™ and ISOPLUS264™** are the DCB substitutes for the corresponding standard packages.

A larger version of this packaging technology is named **ISOPLUS i4-PAC™**. It has up to five terminal pins, making it possible to build up full diode bridges, phase-leg transistor configurations, buck and boost converters and much more within one isolated discrete package.

### Package cross section

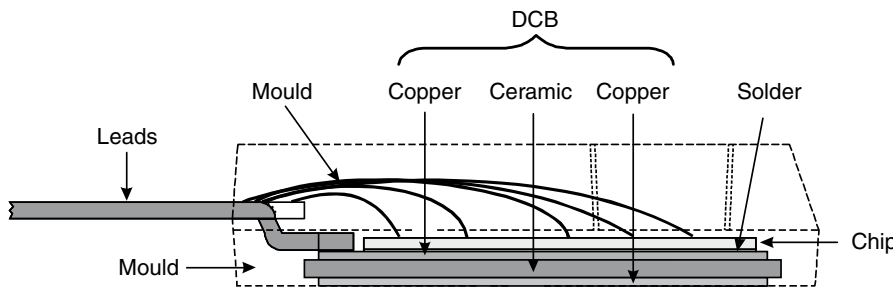

While the junction-to-case thermal resistance is higher than an equivalent, non-isolated device, what really matters is the total thermal resistance from junction-to-heatsink ( $R_{th,JH}$ ). Comparing a device in ISOPLUS247™ to its companion in the non-isolated package with an external isolation foil, one can see that the overall  $R_{th}$  is now lower for the part in the already isolated package (see example).

cycling is reduced so that reliability is improved. Mounting is done with clips, which not only saves time but also guarantees constant pressure force over the whole lifetime of the assembly.

Parts in the **ISOPLUS247™** housing can be identified by the letter "R" in the IXYS part number. Potentially all devices now encapsulated in TO-247, TO-264 and PLUS247™ housings can be molded in the ISOPLUS247™. There are already more than 100 different ISOPLUS247™

**ISOPLUS-DIL™** 37,5 mm long and 25 mm wide provides the largest mounting area within the ISOPLUS™ family. It is available in 2 pin out version: „GWM“ configuration with four power pins for 300 A RMS on one side and 12 control pins on the opposite side and the „GMM“ configuration with 12 pins on either side. The package is intended for high current low voltage (< 200 V) applications either as single switch or 6-pack. With highest power density and high reliability **ISOPLUS-DIL™** is recommended for the use in automotive designs.

**ISOPLUS-SMPD™** is the latest member of IXYS ISOPLUS™ family and provides an increased creepage distance between pins to DCB (>4 mm) and pin to pin (up to 7 mm).

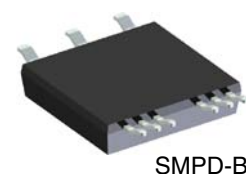

SMPD-B

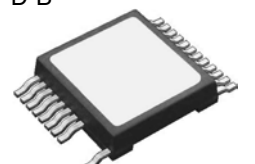

SMPD-X

### Example: ISOPLUS247™ compared to conventional isolated device

Type	Package	Isolation	$R_{thJC}$ K/W	$R_{thCK}$ K/W	Total K/W	Factor
IXFR 180N10	ISOPLUS247™	internal DCB	0.3	0.15	0.45	1
IXFX 180N10	PLUS247™	external foil	0.22	1.02	1.24	2.8

## DCB isolated SMPD package for simplified mounting and high circuit flexibility

Reducing assembly costs is a continual demand of the semiconductor user. One of the various approaches is the usage of SMD packages which is successfully introduced by utilization of Power Semiconductors packaged in TO-263 (D<sup>2</sup>Pak) or TO-268 (D<sup>3</sup>Pak). If heat sinking is required designers have to look for solutions providing isolation and creepage distance.

ISOPLUS-SMPD™ package is the IXYS answer to the challenge to make designer's life easier as it provides an SMD device featuring:

- 2.5 kV isolation to heatsink (UL rating)
- low thermal impedance for good cooling by only 0.38 mm thick ceramic
- more than 4 mm creepage distance from pin to mounting surface
- up to 7 mm creepage from pin to pin (depending on package type)
- high integration such as phase leg or 3~ input rectifier in one package
- automatic mounting by pick & place possible (packaged in Tape & Reel)

This enables the engineer to make flat designs with a concept of distributed power dissipation. The latter allows utilization of heatsinks with a thinner base reducing weight and cost.

The new ISOPLUS-SMPD™ package is small and light weight with two rows of pins, resembling an IC. It allows the assembly to the board in standard SMD pick & place equipment, together with other standard SMD components. ISOPLUS-SMPD™ devices are available in Tape & Reel or in a Blister Tray option.

The complete board including the power components can run through a standard SMD soldering process.

Two types are available. ISOPLUS-SMPD™-B (Fig. 1) is optimized for implementing more complex configurations like phase-legs, buck and boost chopper as well as single – or 3-phase input rectifier bridges, which can ideally be used as building blocks for inverters. ISOPLUS-SMPD™-X (Fig. 2) with a larger number of pins on either side allows the integration of large dies for very high current capability up to 600 A per unit.



Fig. 1 SMPD-B

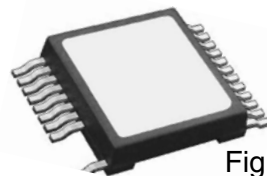

Fig. 2 SMPD-X

Both designs benefit from the ISOPLUS™ construction with low mechanical stress for the die because of a good match in the thermal expansion coefficient of die and DCB resulting in long term reliability.

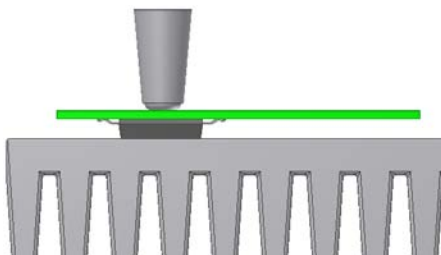

Fig. 3 Mounting example

As normal these devices require a layer of thermal interface material (heat transfer paste) to be applied to the backside of the power devices (or to the heat sink surface alternatively). Then the devices can be mounted together with the PCB to a heat sink.

These power devices need to be pressed down to the heat sink to ensure low thermal resistances. Pressure can be applied in different ways, for example using a mounting clip or a post, applying pressure via the PCB directly to the power device (see Fig. 3 and Fig. 4).

The high package flexibility allows to offer

- high current single Trench MOSFET
- high current single IGBT
- buck and boost converters
- phase-legs with desaturation diodes for switch control
- 1~ or 3~ input rectifiers
- multiple boost stages
- cascade configurations

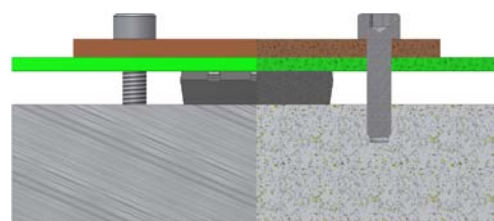

Fig. 4 Mounting example

Customer specific designs are feasible.



# IGBT Modules – SMPD Converter Building Blocks

## ISOPLUS™ Technology

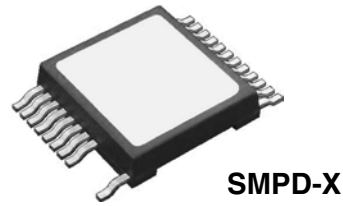
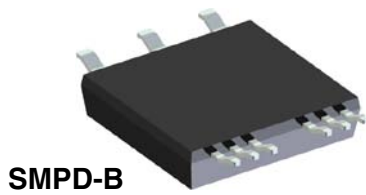

- 2500 V UL rated electrical isolation
- low thermal resistance
- increased power & temperature cycling
- saves space

- replaces multiple discretes
- reduces parasitic inductance & capacitance
- reduces EMI
- heat spreading

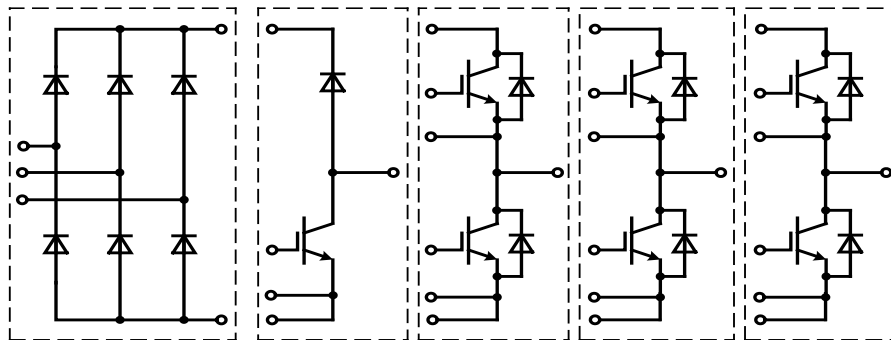

### Rectifier

### Brake & Boost

### Converter

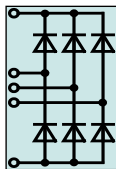

**Line Rectifier**  
DMA90U1800LB  
**SONIC-FRD**  
DHG60U1200LB

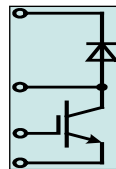

**XPT-IGBT**  
IXA20RG1200DHGLB  
IXA30RG1200DHGLB  
IXA40RG1200DHGLB

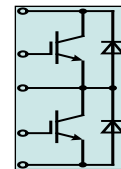

**XPT-IGBT**  
IXA20PG1200DHGLB  
IXA30PG1200DHGLB  
IXA40PG1200DHGLB

IXA35PF650LB  
IXA55PF650LB  
IXA80PF650LB

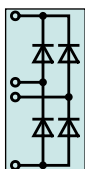

**Line Rectifier**  
DLA100U1200LB  
**Fast Rectifier**  
DPG60B600LB HiPerFRED  
DCG20B650LB SiC  
DHG50B1200LB SONIC  
DCG20B1200LB SiC

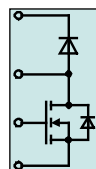

**CoolMOS™**  
MKE38RK600DFELB & FRED  
MKG40RK600LB & SONIC  
MKG40RK600DCGLB & SiC

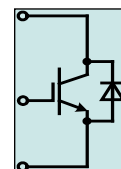

**XPT-IGBT**  
MMIX1X100N60B3H1  
MMIX1X200N60B3H1  
IXD68IF650LB  
IXD90IF650LB  
MMIX1Y82N120C3H1  
MMIX1Y100N120C3H1  
IXA60IF1200DHGLB  
IXA80IF1200DHGLB

## MOSFETs

Type ➤ New ◇ under development	Circuit diagram / Technology	V <sub>DSS</sub> V	I <sub>D25</sub> T <sub>C</sub> = 25°C A	R <sub>DS(on)</sub> typ. T <sub>C</sub> = 25°C mΩ	Q <sub>G</sub> nC	Fig. No.	Circuit Diagram
<b>SINGLE</b>							
MMIX 1T600N04T2	A Trench2	40	600	1.3	590	X031a	
MMIX 1T550N055T2	A Trench2	55	550	1.3	595		
MMIX 1F520N075T2	A Trench2 HiPerFET	75	500	1.6	545		
➤ MMIX 1F420N10T	A Trench HiPerFET	100	334	2,6	670		
MMIX 1F360N15T2	A Trench2 HiPerFET	150	235	4,4	715		
➤ MMIX 1F230N20T	A Trench HiPerFET	200	168	8,3	378		
➤ MMIX 1F180N25T	A Trench HiPerFET	250	130	13	345		
➤ MMIX 1F160N30T	A Trench HiPerFET	300	102	20	335		
➤ MMIX 1F210N30P3	A Polar3 HiPerFET	300	108	16	286		
➤ MMIX 1F132N50P3	A Polar3 HiPerFET	500	63	43	250		
➤ MMIX 1F44N100Q3	A Q3 HiPerFET	1000	30	245	264		
➤ MMIX 1F40N110P	A Polar HiPerFET	1100	24	290	310		
<b>BUCK / BOOST</b>							
MKE 38RK600DFELB	C CoolMOS™ CP & FRED	600	50	40	150	X030a	
◇ MKG 40RK600LB	C CoolMOS™ C6 & SONIC		52	37	290		
◇ MKG 40RK600DCGLB	C CoolMOS™ C6 & SiC		52	37	290		
◇ MCB 21RK1200DCGLC	C SiC Mosfet & SiC Diode	1200	30	80	50	X030b	
<b>PHASE-LEG</b>							
MKE 38P600LB	B CoolMOS™ CP	600	50	40	150	X030a	
◇ MCB 21P1200LC	B SiC Mosfet	1200	30	80	50	X030b	

CoolMOS™ is a trademark of Infineon Technologies

Outline drawings on  
pages O-30...O-55

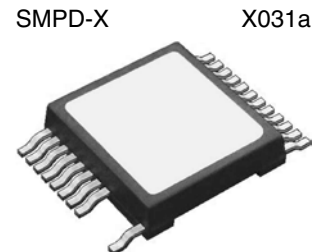
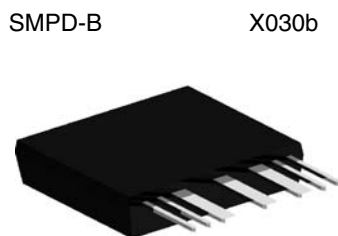
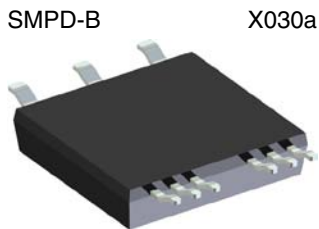

## IGBTs

Type	Circuit Diagram No. / Technology	$V_{CES}$	$I_{C25}$	$V_{CE(sat)}$ typ.	Fig. No.	Circuit Diagram
➤ New		V	A	$T_c = 25^\circ C$		
◇ under development				$T_c = 25^\circ C$		
<b>SINGLE and COPACK</b>						
➤ MMIX 1X200N60B3	D XPT	600	223	1.4	X031a	
➤ MMIX 1G320N60B3	D GenX3 IGBT		400	1.2		
➤ MMIX 1X100N60B3H1	E XPT & SONIC		145	1.5		
➤ MMIX 1X200N60B3H1	E XPT & SONIC		175	1.4		
◇ IXA 110XF650ALB	2xE 2 x XPT	650	2x 72	1.8	X030a	
◇ IXD 80IF650LB	E Trench XPT & SONIC		108	1.65		
◇ IXD 110IF650LB	E Trench XPT & SONIC		145	1.75		
➤ MMIX 1Y82N120C3H1	E XPT fast & SONIC	1200	78	2.9	X031a	
➤ MMIX 1Y100N120C3H1	E XPT fast & SONIC		92	2.9		
◇ IXA 60IF1200DHGLB	E XPT & SONIC		85	1.8	X030a	
◇ IXA 85IF1200DHGLB	E XPT & SONIC		120	1.8		
➤ MMIX 1G120N120A3H1	D GenX3 IGBT @ SONIC		110	1.85	X031a	
➤ MMIX 1G75N250	D IGBT for cap discharge	2500	110	2.5	X031a	
<b>BOOST</b>						
IXA 20RG1200DHGLB	I XPT & SONIC	1200	32	1.8	X030a	
➤ IXA 30RG1200DHGLB	I XPT & SONIC		43	1.9		
IXA 40RG1200DHGLB	I XPT & SONIC		63	1.85		
<b>PHASE-LEG</b>						
➤ MMIX 2S50N60B4D1	F low gain IGBT @ FWD	600	50	1.7	X031c	
◇ IXE 50PF600LB	F fast Trench XPT & SONIC		67	1.6	X030a	
➤ IXA 35PF650LB	F XPT & SONIC	650	44	1.75		
➤ IXA 55PF650LB	F XPT & SONIC		72	1.8		
➤ IXA 80PF650LB	F XPT & SONIC		106	1.8		
IXA 20PG1200DHGLB	G XPT & SONIC	1200	32	1.8		
➤ IXA 30PG1200DHGLB	I XPT & SONIC		43	1.9		
IXA 40PG1200DHGLB	G XPT & SONIC		63	1.85		
➤ IXA 20PT1200LB	K XPT & Thyristor		28	1.8		
<b>FULL-BRIDGE</b>						
➤ MMIX 4G20N250	L IGBT for cap discharge	2500	23	3.1 max	X031b	
➤ MMIX 4B12N300	L BiMOS	3000	26	2.8		
➤ MMIX 4B20N300	L BiMOS		34	2.7		

SMPD-Y

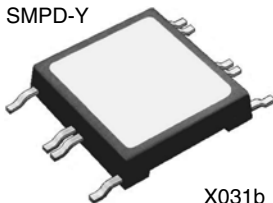

X031b

SMPD-X

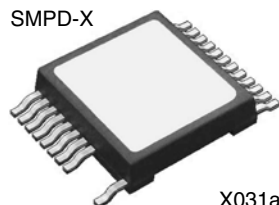

X031a

SMPD-Y

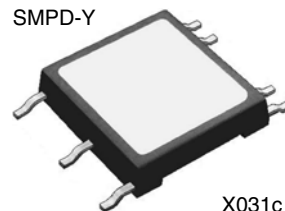

X031c

Outline drawings on pages O-30...O-55

SMPD-B

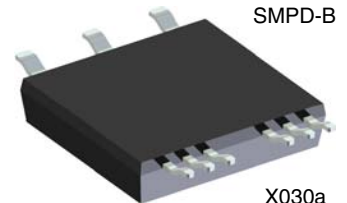

X030a

## Diodes

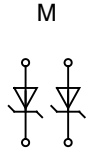
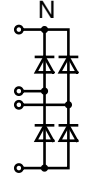
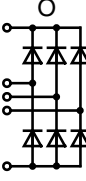
Type ➤ New ◇ under development	Circuit diagram / Diode type	$V_{RRM}$ V	$I_{D(AV)M}$ A	@ $T_c$ °C	Fig. No.	Circuit Diagram
<b>DUAL</b>						
DSA 120X150LB	M Schottky	150	2 x 60	150	X030a	
➤ DSA 120X200LB	M Schottky	200	2 x 60	150		
➤ DSA 240X200LB	M Schottky		2 x 120	150		
<b>1~ BRIDGE</b>						
➤ DPG 60B600LB	N HiPerFRED	600	60	110		
◇ DCG 20B650LB	N SiC	650	20	*		
DLA 100B1200LB	N Rectifier	1200	124	80		
◇ DHG 50B1200LB	N SONIC		50	*		
◇ DCG 20B1200LB	N SiC		20	*		
<b>3~ BRIDGE</b>						
➤ DHG 60U1200LB	O SONIC	1200	62	80		
➤ DMA 90U1800LB	O Rectifier	1800	99	80		

\* in progress

## Thyristors, Triacs

Type ➤ New ◇ under development	Circuit diagram / Bipolar type	$V_{RRM}$ V	$I_{TAV}$ A	@ $T_c$ °C	Fig. No.
<b>DUAL</b>					
◇ CLA 60MU1200LB	2 x P Triac	1200	2 x 30	100	X030a
<b>PHASE-LEG</b>					
◇ CMA 50P1600LB	Q Thyristor	2x 1600	50	90	

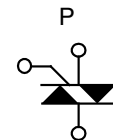

Outline drawings on  
pages O-30...O-55

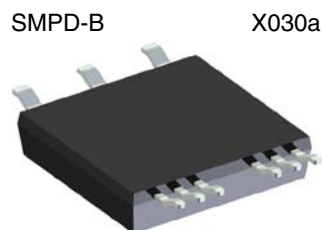

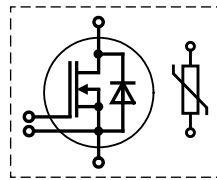

MTC...X...TGD

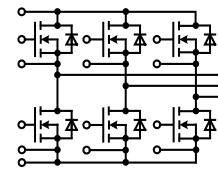

MTI..W...GC

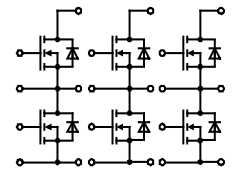

MTI...WX...GD / GMM

**Single high current Switch with NTC**

Type	V <sub>DSS</sub>	I <sub>D25</sub> T <sub>C</sub> = 25°C	I <sub>D90</sub> T <sub>C</sub> = 90°C	R <sub>DS(on)</sub> typ. T <sub>J</sub> = 25°C	C <sub>iss</sub> typ	Q <sub>g</sub> typ	R <sub>thJC</sub>	Fig. No.
◇ under development								
➤ new	V	A	A	mΩ	nF	nC	K/W	
◇ MTC 960X55TGD	55	2x 640	2x 480	1.1	2x 40	2x 595	0.16	X026d
◇ MTC 840X75TGD	75	2x 550	2x 420	1.3	2x 40	2x 545	0.16	

**Six-Pack Trench MOSFET**

Type	V <sub>DS</sub> max.	I <sub>D25</sub> T <sub>C</sub> = 25°C	I <sub>D90</sub> T <sub>C</sub> = 90°C	R <sub>DS(on)</sub> typ. T <sub>C</sub> = 25°C	C <sub>iss</sub> typ	Q <sub>g</sub> typ	R <sub>thJC</sub>	Fig. No.
◇ under development								
➤ New	V	A	A	mΩ	nF	nC	K/W	
➤ MTI 200WX75GD	75	265	200	1.1	10.8	155	0.85	X026d
➤ MTI 85W100GC	100	110	83	3.2	6.3	90	1.45	X026c
➤ MTI 145WX100GD	100	190	145	1.7	11	155	0.85	X026d
GMM 3x60-015X2	150	50	38	19	5.8	97	1.00	

Customized configurations possible

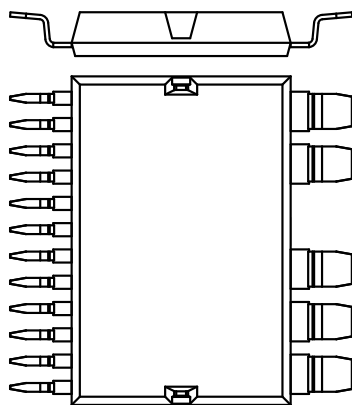

MTI...W..GC  
SURFACE MOUNT DEVICE

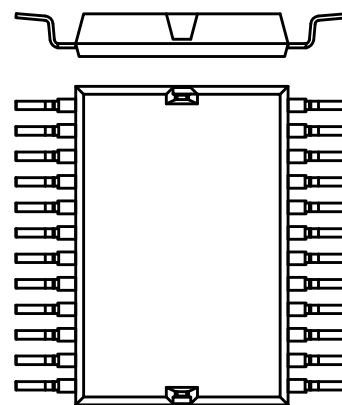

MTI..W...GD  
MTC...X...TGD  
GMM...  
SURFACE MOUNT DEVICE

Outline drawings on pages O-30...O-55

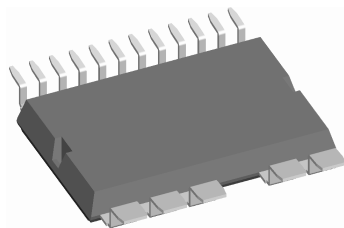

X026c ISOPLUS-DIL™

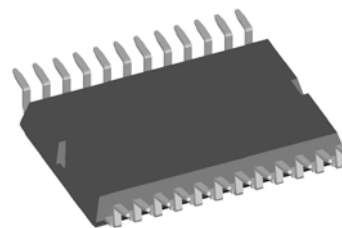

X026d ISOPLUS-DIL™

# ISOPLUS™ i4-PAC™

3, 4 and 5 leaded packages for various circuit topologies

DCB base plate - 2500 V electrical isolation

- low thermal resistance
- increased power & temperature cycling
- saves space
- replaces multiple discretes
- reduces parasitic inductance and capacitance
- reduces EMI
- less weight

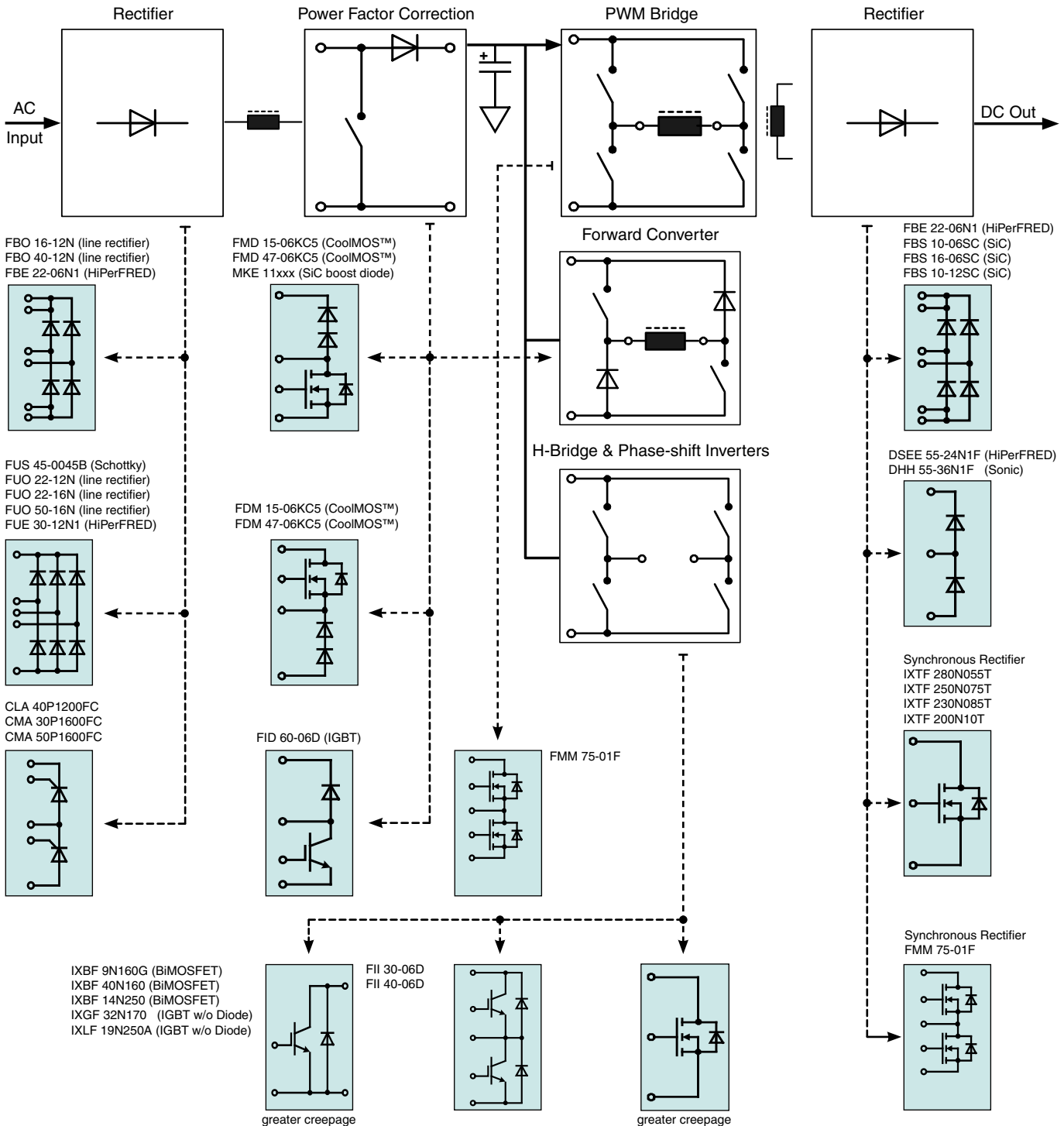
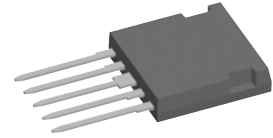

See application note „Combining the features of modules and discretes in a new Power Semiconductor packages“ for general description of the packaging technologies.

See alphanumeric index for the page number of the particular product.

## IGBTs / MOSFETs

Type	Configuration	Circuit diagram / Technology	V <sub>DSS</sub>	I <sub>D25</sub> T <sub>C</sub> = 25°C	I <sub>D90</sub> T <sub>C</sub> = 90°C	R <sub>DS(on)</sub> typ. T <sub>C</sub> = 25°C	Fig. No.	Circuit Diagram		
○ Not for new design ➤ New			V	A	A	mΩ				
<b>IXTF 280N055T</b> <b>IXTF 200N10T</b> <b>IXKF 40N60SCD1</b>	single	A Trench MOSFET	55	160	*	40	X024d			
		A Trench MOSFET	100	90	*	70	X024a			
		G CoolMOS™ & serial Schottky & HiPerFRED free wheeling Diode	600	41	29	60				
➤ <b>IXKF 40N60SCH1</b>		G CoolMOS™ & serial Schottky & SONIC free wheeling Diode	600	41	29	60	X024c			
<b>IXTF 1N250</b>		A High Voltage MOSFET	2500	1	*	40Ω				
<b>IXTF 02N450</b> <b>IXTF 1N450</b>	A High Voltage MOSFET A High Voltage MOSFET	4500 4500	0.2 0.9	* *	750Ω 85Ω					
<b>FDM 15-06KC5</b> <b>FDM 47-06KC5</b>	buck	E CoolMOS™ & HiPerDynFRED E CoolMOS™ & HiPerDynFRED	600 600	15 47	11 32	150 40	X024a			
○ <b>FMD 21-05QC</b> ➤ <b>MPA 22R600DHGFC</b> ➤ <b>MKE 11R600DCGFC</b>	boost	E HiPerFET & HiPerDynFRED C POLAR™ & SONIC Diode C CoolMOS™ & SiC Diode	500 600 600	21 15 15	15 11 11	180 220 150	X024a			
<b>FMD 15-06KC5</b> <b>FMD 40-06KC</b> <b>FMD 47-06KC5</b>		D CoolMOS™ & HiPerDynFRED D CoolMOS™ & HiPerDynFRED D CoolMOS™ & HiPerDynFRED	600 600 600	15 38 47	11 25 32	150 60 40				
<b>FMM 150-0075X2F</b> <b>FMM 75-01F</b>		phase leg	B Trench MOSFET B HiPerFET	75 100	120 75	90 55			5.8 25	X024a
➤ <b>FMP 76-010T</b> ① ➤ <b>FMP 36-015P</b> ① ➤ <b>FMP 26-02P</b> ①			L Trench™ P & N-Channel L Polar™ P & N-Channel L Polar™ P & N-Channel	±100 ±150 ±200	-54 / 62 -22 / 36 -17 / 26	* * *			24 / 11 110 / 40 170 / 60	
➤ <b>FMM 60-02TF</b> ➤ <b>FMM 50-025TF</b> ➤ <b>FMM 22-05PF</b> ➤ <b>FMM 22-06PF</b>	B Trench HiPerFET B Trench HiPerFET B PolarHV™ HiPerFET B PolarHV™ HiPerFET		200 250 500 600	33 30 13 12	- - - -	40 50 270 350				

Type	Configuration	Circuit diagram / Technology	V <sub>CES</sub>	I <sub>C25</sub> T <sub>C</sub> = 25°C	I <sub>C90</sub> T <sub>C</sub> = 90°C (110°C)	V <sub>CE(sat)</sub> typ. T <sub>C</sub> = 25°C	Fig. No.	
			V	A	A	mΩ		
<b>IXBF 9N160G</b> <b>IXBF 40N160</b> <b>IXGF 32N170</b> <b>IXGF 20N250</b> <b>IXGF 25N250</b> <b>IXLF 19N250A</b> <b>IXBF 12N300</b> <b>IXBF 20N300</b> <b>IXGF 20N300</b> <b>IXGF 25N300</b> <b>IXBF 32N300</b> <b>IXGF 36N300</b> <b>IXBF 42N300</b> <b>IXBF 55N300</b> <b>IXGF 30N400</b>	single	I BiMOSFET I BiMOSFET H High voltage IGBT H High voltage IGBT H High voltage IGBT H High voltage IGBT I BiMOSFET I BiMOSFET H High voltage IGBT H High voltage IGBT I BiMOSFET H High voltage IGBT I BiMOSFET I BiMOSFET H High voltage IGBT	1600 1600 1700 2500 2500 2500 3000 3000 3000 3000 3000 3000 3000 3000 4000	7 28 44 23 30 32 26 34 22 27 40 36 60 86 30	4 16 (19) 14 15 19 (11) (14) (14) (16) 22 (24) (34) 15	4.9 6.2 max 3.5 max 3.1 max 2.9 max 3.9 2.8 2.7 max 3.2 max 3.0 2.8 max 2.7 2.5 2.7 max 3.1	X024c	
<b>FID 60-06D</b> <b>FII 30-06D</b> <b>FII 40-06D</b>		boost phase leg phase leg	K NPT IGBT & HiPerFRED J NPT IGBT J NPT IGBT	600 600 600	65 30 40	40 18 25	1.6 1.9 1.8	X024a

\* in progress

CoolMOS™ is a trademark of Infineon Technologies

Outline drawings on pages O-30...O-55

① high side switch: p-channel; low side switch: n-channel

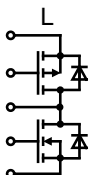
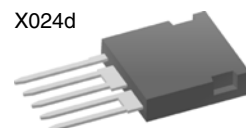
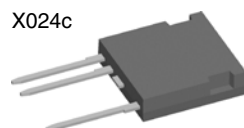
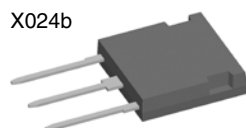
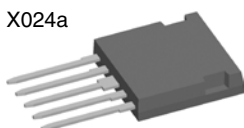

## Bipolar

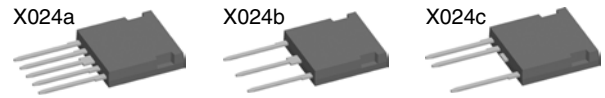

Type	Configuration	Circuit diagram / Diode type	Voltage	$I_{D(AV)M}$ $T_c = 90^\circ\text{C}$	Fig. No.	Circuit Diagram
➤ New			V	A		
➤ CNA 10E2500FB CS 20-22moF1 CS 20-25mo1F	single part, high voltage	R Thyristor R Thyristor R Thyristor	2500 2200 2500	10 18 18	X024c	
➤ DSEE 55-24N1F CLA 40P1200FC CMA 30P1600FC CMA 50P1600FC DHH 55-36N1F	phase leg	L HiperFRED Q Thyristor Q Thyristor Q Thyristor L Sonic-FRD	2x 1200 2x 1200 2x 1600 2x 1600 2x 1800	55 40 30 50 50	X024b X024a X024b	
FBS 10-06SC FBS 16-06SC FBE 22-06N1 FBO 16-12N FBS 10-12SC FBO 40-12N	1-phase bridge	M Si-Carbide M Si-Carbide N HiperFRED N Rectifier M Si-Carbide N Rectifier	600 600 600 1200 1200 1200	6.6 11 20 22 10 40	X024a	
FUS 45-0045B FUE 30-12N1 FUO 22-12N FUO 22-16N FUO 50-16N	3-phase bridge	P Schottky O HiperFRED O Rectifier O Rectifier O Rectifier	45 1200 1200 1600 1600	45 30 27 27 50		





# Insulated Gate Bipolar Transistors (IGBT)

The Insulated Gate Bipolar Transistor (IGBT) is a three terminal device combining high efficiency with fast switching capabilities. IXYS offers various IGBT technologies optimized for the many topologies, circuits and requirements in today's varied power semiconductor applications. As a guide to the multiple technologies of IGBT on offer from IXYS please refer to the following characteristics.

$V_{CE(sat)}$  – a measure of on-state losses i.e. power dissipation when the device is passing forward current. The higher the  $V_{CE(sat)}$  the higher the losses in the forward direction.

**Switching Speed** – an IGBT with fast switching speed will have higher efficiency during the transition from on to the off state and vice versa. Low switching speed versions are often combined with low  $V_{CE(sat)}$  for low frequency applications. Higher speed IGBT tend to have higher  $V_{CE(sat)}$ .

**Temperature Coefficient** – this determines the device  $V_{CE(sat)}$  trend against temperature. A device is said to have a positive temperature coefficient if the  $V_{CE(sat)}$  rises when the junction temperature increases. Likewise a negative temperature coefficient is when the devices  $V_{CE(sat)}$  reduces when the junction temperature increases. A positive temperature coefficient is required when operating IGBT in parallel. A negative temperature coefficient device cannot be operated in parallel but may have lower losses at higher temperatures.

**Safe Operating Area (SOA)** – the ability for an IGBT to sustain voltage and current in shorter time scales without failure. Forward bias (FBSOA) is SOA when turning the IGBT into the on-state. Reverse Bias (RBSOA) is SOA when turning to the off-state. Short circuit SOA (SCSOA) is an indication of ability to withstand surge currents in operation.

**Avalanche Rated** – the ruggedness of the IGBT in the avalanche region. An avalanche rated devices is far more rugged than alternative devices during operation and is an indication of reliability.

## IGBT technology

IGBT Characteristic	Punch Through (PT)			Non-Punch Through (NPT)	XPT Planar	XPT GenX3		XPT Trench		BiMOSFET (RC IGBT)			High voltage IGBT		
	IXG..	IXG..	IXG..			IXA..	IXY..	IXX..	IXX..	IXB..	IXB..	IXB..	IXG..	IXG..	IXG..
Discrete Part No. Prefix	A	B	C	NONE	NONE	B3	C3	B4	C4	NONE	A (1700V)	C	NONE	A	C
Discrete Part No. Suffix	LOW	MED.	HIGH	MEDIUM	MED.	MED.	HIGH	LOW	MED.	LOW	MED.	HIGH	LOW	MED.	HIGH
$V_{CE(sat)}$	LOW	MED.	HIGH	MEDIUM	MED.	MED.	HIGH	LOW	MED.	LOW	MED.	MED.	LOW	MED.	MED.
Switching speed	POS	NEG	NEG	POSITIVE	POSITIVE	POSITIVE	POSITIVE	POSITIVE	POSITIVE	POSITIVE	POSITIVE	POSITIVE	POSITIVE	POSITIVE	POSITIVE
Safe Operating Area	RBSOA			SCSOA RBSOA FBSOA	SCSOA RBSOA FBSOA	SCSOA RBSOA FBSOA	SCSOA RBSOA FBSOA	SCSOA RBSOA	SCSOA RBSOA	SCSOA RBSOA	SCSOA RBSOA	SCSOA RBSOA	SCSOA RBSOA FBSOA	SCSOA RBSOA FBSOA	SCSOA RBSOA FBSOA
Avalanche rated	NO	NO/ YES	YES	YES	YES	YES	YES	NO	NO	NO	NO	NO	NO	NO	YES
Voltage range	300-1200V			600-1700V	600-1200V	650 / 650 / 900 / 1200V	650V	650V	650V	1600-3000V	1600-3000V	1600-3000V	1600-4500V	1600-4500V	1600-4500V

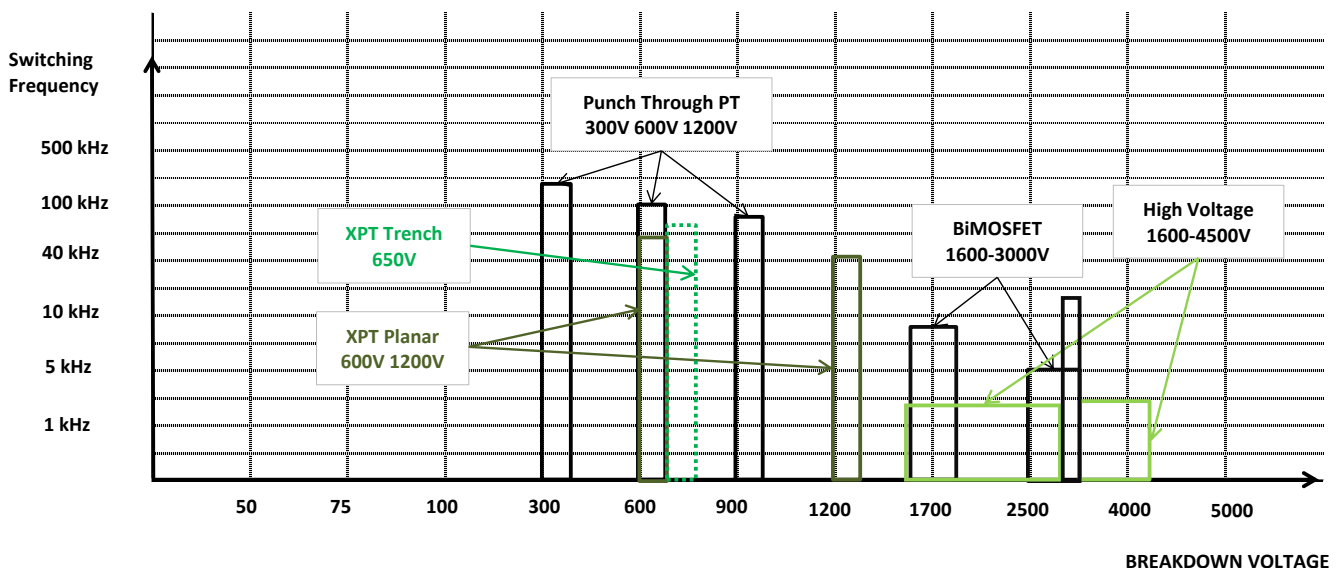

# Insulated Gate Bipolar Transistors (IGBT)

---

## IGBT product families

### Xtreme Light Punch Through (XPT) Plar IGBTs

are an extremely rugged technology platform of IGBTs, which are ideal for critical applications that require low conduction and low switching losses with a 10  $\mu$ s short circuit withstand capability. Either discrete or co-packaged with ultrafast soft recovery Sonic diodes, IXYS XPT IGBTs have lower saturation voltage  $V_{CE(sat)}$  and low total switching energy ( $E_{on} + E_{off}$ ). A large portfolio of module packed XPT Plar are available for applications such as UPS, Motor Drive and solar inverters.

### Xtreme Light Punch Through (XPT) Trench IGBTs

are the latest development from IXYS starting at 650V. This range features not only a low  $V_{CE(sat)}$  but extremely low switching losses making the platform attractive for fast switching applications whilst retaining good SOA rating and a positive temperature coefficient. Either discrete or co-packaged with ultrafast soft recovery Sonic diodes, IXYS XPT IGBTs have industry leading efficiency at medium to high switching frequency.

### G-Series, A, B & C Class (GenX™) (PT) IGBTs

These IGBTs are manufactured using IXYS' advanced GenX™ Punch-Through IGBT process providing lower saturation voltages, and lower switching losses. A, B, C speed classes provide optimum trade off between static (conduction) and dynamic (switching) losses. Co-packed variants of these devices are available with IXYS' HiPerFRED™ (suffix "D1") and SONIC-FRD™ (suffix "H1") ultrafast recovery diodes

### G-series, B3 & C3 Class (GenX3™) (PT) IGBTs with SiC Anti-Parallel Diode

IXYS has combined the latest Silicon Carbide diode technology with its advanced GenX3™ IGBT platform. The prime benefit presented by these SiC ultra-fast co-packed diodes lies their ability to switch rapidly (<50 ns), with nearly zero reverse recovery charge (Qrr), resulting in negligible commutation losses, reduced turn-on energy ( $E_{on}$ ) of the IGBT, and reduced EMI emissions.

### 1600 V & 1700 V Low Sat IGBTs

These rugged High Voltage NPT devices are designed for capacitor discharge applications, featuring a low saturation voltage, high power density, & high peak current capability. These High Voltage NPT IGBTs enable the elimination of more costly, lower performance solutions such as thyristors or series connected MOSFETs or IGBTs typically used at voltages above 1200 V. Offered as co-packs, they provide a more complete solution for power conversion applications.

### 1600 V & 1700 V High Speed IGBTs

This family of 1600/1700 V IGBTs are rugged NPT devices targeted for high voltage applications, requiring 10  $\mu$ s short circuit withstand capability. They are particularly suitable for high voltage switching applications. IXYS offers its fast switching "A" version 1700 V NPT IGBTs in co-pack and phase-leg configurations for PWM applications with switching frequencies upwards of 50 kHz.

### Very High Voltage (2500 V - 4000 V) IGBTs

IXYS' offers a unique portfolio of discrete 2500V, 3000V, and 4000V VHV IGBTs with collector current ratings spanning from 2 A to 75 A ( $TC = 110^{\circ}C$ ). The voltage and current ratings of these devices, coupled with simplified MOS gate-control, allow the system designer to greatly reduce the complexity of many high voltage switching designs. These IGBTs enable the use of a single device in systems whose circuits previously used multiple, cascaded, lower-voltage switches.

### B-series (BiMOSFET) IGBTs





IXYS BiMOSFETs are devices which have combined strengths of MOSFETs and IGBTs. BiMOSFETs feature a monolithic intrinsic diode which can reduce die count in many applications.

# Discrete XPT

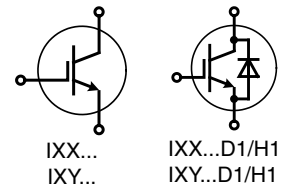
## XPT IGBT

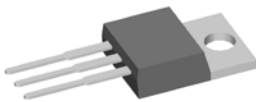
XPT = Xtreme light Punch Through, short-circuit rated IGBTs

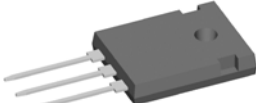
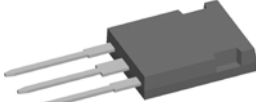
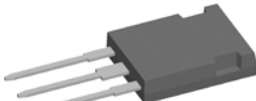
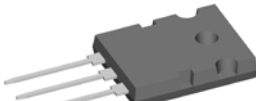

Part Number	V <sub>CES</sub>	I <sub>C25</sub>	I <sub>C110</sub>	V <sub>CE(sat)</sub>	t <sub>fi</sub> typ.	E <sub>off</sub> typ.	R <sub>thJC</sub>	Diode	I <sub>F110</sub>	R <sub>thJC</sub>	P <sub>C</sub>	Fig. No.	Package style Outline drawings on pages O-30...O-55	
		T <sub>C</sub> = 25°C	T <sub>C</sub> = 110°C	T <sub>C</sub> = 25°C	T <sub>J</sub> = 150°C	T <sub>J</sub> = 150°C	Diode T <sub>C</sub> = 110°C		max. Diode	W				
<b>600 / 650V GenX3™ XPT™ IGBTs</b>														
➤ IXXH 30N60B3	600	60	30	1.85	180	0.7	0.55				270	X014a	X005a <b>TO-220AB</b> 	
IXXH 30N60B3D1		60	30	1.85	180	0.7	0.55	• 30	0.9	270	X014a			
IXXH 30N60C3D1		60	30	2.2	78	0.4	0.55	• 30	0.9	270	X014a			
IXXH 50N60C3		100	50	2.3	90	0.48	0.25				600	X014a	X011b <b>TO-263AB</b> 	
IXXH 50N60C3D1		100	50	2.3	90	0.48	0.25	• 30	0.9	600	X014a			
IXXA 50N60B3		120	50	1.8	190	1.2	0.25				600	X011b		
IXXH 50N60B3		120	50	1.8	190	1.2	0.25				600	X014a		
IXXH 50N60B3D1		120	50	1.8	190	1.2	0.25	• 30	0.9	600	X014a			
IXXP 50N60B3	120	50	1.8	190	1.2	0.25				600	X005a			
IXXR 100N60B3H1	145	68	1.8	200	2.8	0.31	• -	0.62	400	X016a				
IXXH 75N60C3	150	75	2.3	80	1.07	0.2				750	X014a			
IXXH 75N60C3D1	150	75	2.3	80	1.07	0.2	• 30	0.9	750	X014a	X011c <b>TO-263AB</b> 			
IXXH 75N60B3	160	75	1.85	170	2.2	0.2				750		X014a		
IXXH 75N60B3D1	160	75	1.85	170	2.2	0.2	• 30	0.9	750	X014a				
IXXK 100N60C3H1	170	-	2.2	115	1.4	0.18	• 65	0.3	695	X020a	X014a <b>TO-247AD</b> 			
IXXN 100N60B3H1	170	-	1.8	200	2.8	0.25	• 50	0.42	500	X027a				
IXXX 100N60C3H1	170	-	2.2	115	1.4	0.18	• 65	0.3	695	X015a				
IXXH 100N60C3	190	100	2.2	115	1.4	0.18				830		X014a		
IXXK 100N60B3H1	200	-	1.8	200	2.8	0.18	• 65	0.3	695	X020a				
IXXN 200N60B3H1	200	98	1.7	215	3.45	0.16	• 30	0.7	780	X027a				
IXXN 200N60C3H1	200	98	2.1	90	2.1	0.16	• 30	0.7	780	X027a				
IXXX 100N60B3H1	200	-	1.8	200	2.8	0.18	• 65	0.3	695	X015a				
IXXH 100N60B3	220	100	1.8	200	2.8	0.18				830		X014a		
IXXN 200N60B3	280	160	1.7	215	3.45	0.16				940		X027a		
IXXK 200N60C3	340	200	2.1	90	2.1	0.092				1630	X020a	X015a <b>PLUS247</b> 		
IXXX 200N60C3	340	200	2.1	90	2.1	0.092				1630	X015a			
IXXK 200N60B3	380	200	1.7	215	3.45	0.092				1630	X020a			
IXXX 200N60B3	380	200	1.7	215	3.45	0.092				1630	X015a			
IXXK 300N60C3	510	300	2	90	2.35	0.065				2300	X020a			
IXXX 300N60C3	510	300	2	90	2.35	0.065				2300	X015a			
IXXK 300N60B3	550	300	1.6	200	3.7	0.065				2300	X020a			
IXXX 300N60B3	550	300	1.6	200	3.7	0.065				2300	X015a			
➤ IXXA 30N65C3HV	650	52	30	2.2	78	0.4	0.65				230		X011c	X016a <b>ISOPLUS247™</b> 
➤ IXYH 40N65C3H1		80	40	2.2	80	0.46	0.5	• 29	0.8	300	X014a			
<b>650V GenX4™ XPT™ Trench IGBTs</b>														
➤ IXXH 30N65B4	650	65	30	2	100	0.6	0.65				230	X014a	X020a <b>TO-264</b> 	
➤ IXXH 60N65B4H1		116	60	2	94	1.34	0.33	• 48	0.62	380	X014a			
➤ IXXH 60N65B4		116	60	2	94	1.34	0.33				455	X014a		
➤ IXXH 60N65C4		118	60	2.2	47	0.93	0.33				455	X014a		
➤ IXXH 40N65B4		120	40	1.8	73	0.78	0.33				455	X014a		
➤ IXXR 110N65B4H1		150	70	2.15	105	1.4	0.33	• 48	0.7	455	X016a			
➤ IXXH 80N65B4		160	80	2	65	1.65	0.24				625	X014a	X027a <b>SOT-227B miniBLOC</b> 	
➤ IXXH 80N65B4H1		160	80	2	65	1.65	0.24	• 62	0.45	625	X014a			
➤ IXXN 110N65C4H1		210	110	2.35	43	0.77	0.2	• 52	0.42	750	X027a			
➤ IXXN 110N65B4H1		215	110	2.1	105	1.4	0.2	• 52	0.42	750	X027a			
➤ IXXH 110N65C4		234	110	2.35	43	0.77	0.17				880	X014a		
➤ IXXK 110N65B4H1		240	110	2.1	105	1.4	0.17	• 52	0.42	880	X020a			
➤ IXXX 110N65B4H1		240	110	2.1	105	1.4	0.17	• 52	0.42	880	X015a			
➤ IXXK 160N65C4		290	160	2.1	57	1.3	0.16				940	X020a		
➤ IXXX 160N65C4		290	160	2.1	57	1.3	0.16				940	X015a		
➤ IXXK 160N65B4		310	160	1.8	160	2.36	0.16				940	X020a		
➤ IXXX 160N65B4		310	160	1.8	160	2.36	0.16				940	X015a		
➤ IXXK 200N65B4		370	200	1.7	110	2.54	0.13				1150	X020a		
➤ IXXX 200N65B4		370	200	1.7	110	2.54	0.13				1150	X015a		

## XPT IGBT

XPT = Xtreme light Punch Through

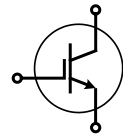

IXY ...

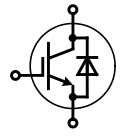

IXY...D1/H1

Part Number	V <sub>CES</sub>	I <sub>C25</sub> T <sub>C</sub> = 25°C	I <sub>C110</sub> T <sub>C</sub> = 110°C	V <sub>CE(sat)</sub> T <sub>C</sub> = 25°C	t <sub>fi</sub> typ. T <sub>J</sub> = 125°C	E <sub>off</sub> typ. T <sub>J</sub> = 125°C	R <sub>thJC</sub>	Diode	I <sub>F110</sub> Diode T <sub>C</sub> = 110°C	R <sub>thJC</sub> max. Diode	P <sub>C</sub>	Fig. No.	Package style	
														Outline drawings on pages O-30...O-55
➤ New														
<b>1200V GenX3™ XPT™ IGBTs</b>														
➤ IXYJ 20N120C3D1	1200	16	7	4	° 105	0.7 °	1.78	•	19	1.1	70	X016c	X005a	<b>TO-220AB</b>
➤ IXYH 20N120C3D1	1200	36	17	4	° 105	0.7 °	0.54	•	23	0.9	230	X014a		
➤ IXYT 20N120C3D1HV	1200	36	17	4	° 105	0.7 °	0.54	•	23	0.9	230	X019a		
➤ IXYH 20N120C3	1200	40	20	4	° 105	0.7 °	0.54				278	X014a		
➤ IXYP 20N120C3	1200	40	20	4	° 105	0.7 °	0.54				278	X005a		
➤ IXYR 50N120C3D1	1200	56	* 32	4	° 60	1.4 °	0.43	•	25	0.9	290	X016a		
➤ IXYH 40N120C3D1	1200	64	* 40	4	38	0.7	0.26	•	25	0.9	480	X014a	X014a	<b>TO-247AD</b>
➤ IXYH 30N120C3	1200	66	30	4	88	0.9	0.3				416	X014a		
➤ IXYH 30N120C3D1	1200	66	30	4	88	0.9	0.3	•	25	0.9	416	X014a		
➤ IXYP 30N120C3	1200	66	30	4	88	0.9	0.3				416	X005a		
➤ IXYH 40N120C3	1200	70	40	4	38	0.7	0.26				577	X014a		
➤ IXYH 40N120B3D1	1200	86	40	2.9	206	2.05	0.26	•	25	0.9	480	X014a		
➤ IXYH 50N120C3D1	1200	90	** 50	4	° 60	1.4 °	0.2	•	25	0.9	625	X014a	X015a	<b>PLUS247</b>
➤ IXYH 40N120B3	1200	96	40	2.9	206	2.05	0.26				577	X014a		
➤ IXYH 50N120C3	1200	100	50	3.5	60	1.4	0.2				750	X014a		
➤ IXYR 100N120C3	1200	104	58	3.5	125	3.55	0.31				484	X016a		
➤ IXYN 82N120C3	1200	105	46	3.2	95	3.7	0.25				500	X027a		
➤ IXYN 82N120C3H1	1200	105	46	3.2	95	3.7	0.25	•	42	0.42	500	X027a		
➤ IXYN 100N120C3H1	1200	134	62	3.5	125	3.55	0.18	•	42	0.42	690	X027a		
➤ IXYN 100N120C3	1200	152	86	3.5	125	3.55	0.18				830	X027a		
➤ IXYB 82N120C3H1	1200	160	82	3.2	95	3.7	0.12	•	42	0.35	1040	X021a		
➤ IXYH 82N120C3	1200	160	82	3.2	95	3.7	0.12				1040	X014a		
➤ IXYN 100N120B3H1	1200	165	76	2.6	° 260	10.1 °	0.18	•	42	0.42	690	X027a	X016a	<b>ISOPLUS247™</b>
➤ IXYK 100N120C3	1200	188	100	3.5	125	3.55	0.13				1150	X020a		
➤ IXYX 100N120C3	1200	188	100	3.5	125	3.55	0.13				1150	X015a		
➤ IXYK 120N120C3	1200	220	120	3.5	° 120	5.3 °	0.1				1500	X020a		
➤ IXYX 120N120C3	1200	220	120	3.5	° 120	5.3 °	0.1				1500	X015a		
➤ IXYK 100N120B3	1200	225	100	2.6	° 260	10.1 °	0.13				1150	X020a	X016c	<b>ISO247™</b>
➤ IXYX 100N120B3	1200	225	100	2.6	° 260	10.1 °	0.13				1150	X015a		

\* T<sub>C</sub> = 90°C

° T<sub>J</sub> = 150°C

\*\* T<sub>C</sub> = 100°C

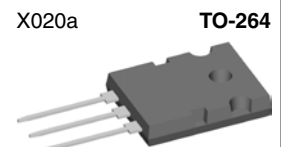
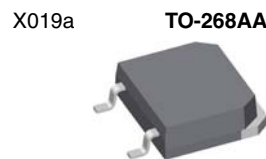
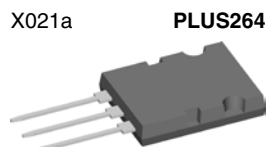
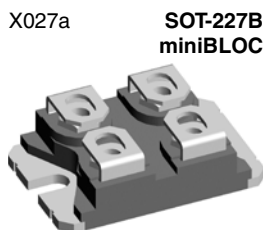





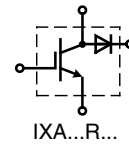

# Discrete XPT / NPT IGBT

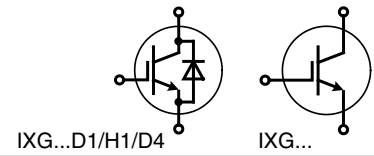
XPT IGBT    NPT = Non Punch Through

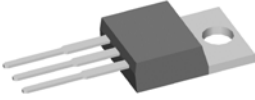

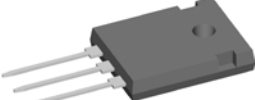
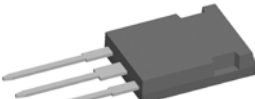
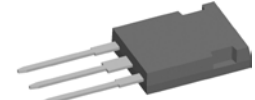
Type	V <sub>CES</sub>	I <sub>C25</sub> IGBT	I <sub>C90</sub> IGBT	V <sub>CEsat typ</sub> IGBT	E <sub>off</sub> IGBT	R <sub>thJC</sub> IGBT	Diode	I <sub>F90</sub> Diode	Fig. No.	Package style
○ Not for new design		T <sub>C</sub> = 25°C	T <sub>C</sub> = 90°C	T <sub>J</sub> = 25°C	T <sub>J</sub> = 125°C			T <sub>C</sub> = 90°C		Outline drawings on pages O-30...O-55
➤ New		A	A	V	mJ	K/W		A		
◇ under development	V									
<b>600 / 650 V XPT IGBT</b>										
◇ IXB 80IF600NA	600	120	80	*	*	*	•	*	X027a	X004 <b>TO-252AA</b>
◇ IXB 200I600NA		300	200	*	*	*	•	-	X027a	
◇ IXD 75IF650NA	650	115	75	*	*	*	•	*	X027a	
◇ IXA 90IF650NA		135	90	*	*	*	•	*	X027a	
◇ IXA 220I650NA		335	220	*	*	*	•	-	X027a	
<b>1200 V XPT IGBT</b>										
IXA 4IF1200UC	1200	9	5	1.8	0.25	2.70	•	6	X004	X005a <b>TO-220AB</b>
➤ IXA 4IF1200TZ		9	5	1.8	0.25	2.70	•	6	X019a	
IXA 12IF1200HB		20	13	1.8	1.10	1.50	•	14	X014a	
IXA 12IF1200PB		20	13	1.8	1.10	1.50	•	14	X005a	
➤ IXA 12IF1200PZ		20	13	1.8	1.10	1.50	•	14	X011c	X011b <b>TO-263AB</b>
IXA 12IF1200TC		20	13	1.8	1.10	1.50	•	14	X019	
IXA 17IF1200HJ		28	18	1.8	1.70	1.26	•	19	X016a	
IXA 20IF1200HB		38	22	1.8	1.70	0.76	•	24	X014a	
IXA 20I1200PB		38	22	1.8	1.70	0.76	•	-	X005a	
➤ IXA 20I1200PZ		38	22	1.8	1.70	0.76	•	-	X011c	X011c <b>TO-263AB</b>
IXA 27IF1200HJ		43	27	1.8	3.00	0.84	•	25	X016a	
IXA 33IF1200HB		58	34	1.8	3.00	0.50	•	33	X014a	
IXA 37IF1200HJ		58	37	1.8	4.10	0.64	•	25	X016a	
IXA 45IF1200HB		78	45	1.8	4.10	0.38	•	33	X014a	
IXA 55I1200HJ		84	54	1.8	5.50	0.43	•	-	X016a	
IXA 60IF1200NA		88	56	1.8	5.50	0.43	•	51	X027a	X014a <b>TO-247AD</b>
IXA 70I1200NA		100	65	1.8	5.50	0.35	•	-	X027a	
➤ IXA 70R1200NA**		100	65	1.8	5.50	0.35	•	55	X027a	
* in progress; ** boost configuration										
<b>NPT IGBT    NPT = Non Punch Through</b>										
<b>600 V NPT IGBT</b>										
IXDP 20N60B	600	32	20	2.2	0.4	0.90		-	X005a	X016a <b>ISOPLUS247™</b>
IXDP 20N60BD1		32	20	2.2	0.4	0.90	•	14	X005a	
○ IXDP 35N60B		60	35	2.1	0.8	0.50		-	X005a	
○ IXDH 35N60B		60	35	2.1	0.8	0.50		-	X014a	X019 <b>TO-268AA</b>
IXDH 35N60BD1		60	35	2.1	0.8	0.50	•	21	X014a	
○ IXDR 35N60BD1		60	24	2.1	0.8	1.00	•	18	X016a	
<b>1200 V NPT IGBT</b>										
IXDA 20N120AS	1200	34	25	2.8	2.4	0.63		-	X011b	
IXDH 20N120		38	25	2.4	2.4	0.63		-	X014a	
IXDH 20N120D1		38	25	2.4	2.4	0.63	•	20	X014a	X019a <b>TO-268AA</b>
○ IXDH 30N120		60	38	2.4	3.4	0.42		-	X014a	
○ IXDH 30N120D1		60	38	2.4	3.4	0.42	•	35	X014a	
○ IXDR 30N120		50	30	2.4	3.4	0.60		-	X016a	
○ IXDR 30N120D1		50	30	2.4	3.4	0.60	•	27	X016a	
IXDN 55N120D1		100	62	2.3	6.2	0.28	•	60	X027a	X027a <b>SOT-227B miniBLOC</b>
IXDN 75N120		150	95	2.2	10.5	0.19		-	X027a	

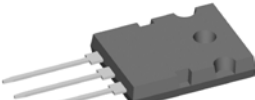
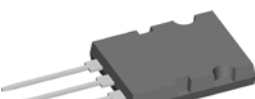

Part Type	V <sub>CES</sub>	I <sub>C</sub> T <sub>C</sub> = 25°C	I <sub>C</sub> T <sub>C</sub> = 110°C	V <sub>CE(sat)</sub> T <sub>C</sub> = 25°C	t <sub>fi</sub> typ T <sub>J</sub> = 25°C	E <sub>off</sub> typ T <sub>J</sub> = 125°C	R <sub>thJC</sub>	Diode	R <sub>thJC</sub> Diode	P <sub>C</sub>	Fig. No.	Package Style
➤ New	V	A	A	V	ns	mJ	K/W		K/W	W		Outline drawings on pages O-30...O-55
IXGH 100N30B3	300	75	100	1.7	33		0.27	-		460	X014a	X005a <b>TO-220AB</b>
IXGH 120N30B3		75	120	1.7	64		0.23	-		540	X014a	
IXGH 60N30C3		75	60	1.8	68	0.3	0.42	-		300	X014a	
IXGH 85N30C3		75	85	1.9	70	0.39	0.375	-		333	X014a	
IXGH 100N30C3		75	100	1.85	94	0.52	0.27	-		460	X014a	
IXGH 120N30C3		75	120	2.1	86	0.73	0.23	-		540	X014a	X011b <b>TO-263AB</b>
IXGK 400N30A3		400	200	1.15	107		0.125	-		1000	X020a	
IXGN 400N30A3		400	200	1.15	107		0.17	-		735	X027a	
IXGX 400N30A3		400	200	1.15	107		0.125	-		1000	X015a	
IXGA 42N30C3			42	1.8	65	0.2	0.56	-		223	X011b	X014a <b>TO-247AD</b>
IXGH 42N30C3			42	1.8	65	0.2	0.56	-		223	X014a	
IXGP 42N30C3			42	1.8	65	0.2	0.56	-		223	X005a	
IXGR 48N60C3D1	600	56	26	2.7	38	0.57	1	•	1.5	125	X016a	
IXGA 30N60C3		60	30	3	47	0.33	0.56	-		220	X011b	
IXGA 30N60C3D4		60	30	3	47	0.33	0.56	•	2.5	220	X011b	X015a <b>PLUS247</b>
IXGH 30N60C3		60	30	3	47	0.33	0.56	-		220	X014a	
IXGH 30N60C3D1		60	30	3	47	0.33	0.56	•	0.9	220	X014a	
IXGP 30N60C3		60	30	3	47	0.33	0.56	-		220	X005a	
IXGP 30N60C3D4		60	30	3	47	0.33	0.56	•	2.5	220	X005a	
IXGR 48N60B3		60	27	2.1	116	1.3	0.83	-		150	X016a	X016a <b>ISOPLUS247™</b>
IXGR 48N60B3D1		60	27	2.1	116	1.3	0.83	•	1.5	150	X016a	
IXGT 30N60C3D1		60	30	3	47	0.33	0.56	•	0.9	220	X019	
IXGP 30N60C3C1		60	30	3	47	0.33	0.56	•	1.1	220	X005a	
IXGH 28N60B3D1		66	28	1.8	100	1	0.66	•	1	190	X014a	
IXGA 48N60C3		75	48	2.5	38	0.57	0.42	-		300	X011b	X019 <b>TO-268AA</b>
IXGB 200N60B3		75	200	1.5	183	4.2	0.1	-		1250	X021a	
IXGH 36N60A3D4		75	36	1.4	325	5.3	0.56	•	2.5	220	X014a	
IXGH 48N60A3D1		75	48	1.35	224	5.6	0.42	•	0.9	300	X014a	
IXGH 48N60C3		75	48	2.5	38	0.57	0.42	-		300	X014a	
IXGH 48N60C3D1		75	48	2.5	38	0.57	0.42	•	0.9	300	X014a	
IXGH 60N60C3		75	60	2.5	50	0.8	0.33	-		380	X014a	X020a <b>TO-264</b>
IXGH 60N60C3D1		75	60	2.5	50	0.8	0.33	•	0.9	380	X014a	
IXGH 72N60A3		75	72	1.35	250	6.5	0.23	-		540	X014a	
IXGH 72N60B3		75	72	1.8	90	2.2	0.23	-		540	X014a	
IXGH 72N60C3		75	72	2.5	55	0.93	0.23	-		540	X014a	
IXGH 90N60B3		75	90	1.8	148	2.8	0.19	-		660	X014a	X021a <b>PLUS264</b>
IXGK 72N60A3H1		75	72	1.35	250	6.5	0.23	•	0.3	540	X020a	
IXGK 72N60B3H1		75	72	1.8	92	2.2	0.23	•	0.3	540	X020a	
IXGP 48N60C3		75	48	2.5	38	0.57	0.42	-		300	X005a	
IXGR 60N60C3D1		75	30	2.5	50	0.8	0.73	•	1.5	170	X016a	
IXGR 72N60A3H1		75	72	1.35	250	6.5	0.62	•	0.8	200	X016a	X027a <b>SOT-227B miniBLOC</b>
IXGR 72N60B3D1		75	40	1.8	90	2.2	0.62	•	0.85	200	X016a	
IXGR 72N60B3H1		75	40	1.8	92	2.2	0.62	•	0.8	200	X016a	
IXGR 72N60C3D1		75	35	2.7	55	0.93	0.62	•	0.85	200	X016a	
IXGT 60N60C3D1		75	60	2.5	50	0.8	0.33	•	0.9	380	X019	
IXGT 72N60A3		75	72	1.35	250	6.5	0.23	-		540	X019	

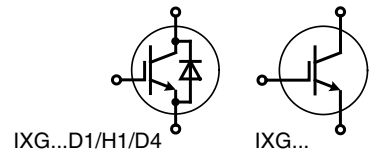

Part Type	V <sub>CES</sub> V	I <sub>C</sub>		V <sub>CE(sat)</sub> V	t <sub>fi</sub> typ T <sub>J</sub> = 25°C ns	E <sub>off</sub> typ T <sub>J</sub> = 125°C mJ	R <sub>thJC</sub> K/W	Diode	R <sub>thJC</sub> Diode K/W	P <sub>C</sub> W	Fig. No.	Package Style
		T <sub>C</sub> = 25°C A	T <sub>C</sub> = 110°C A									
➤ New	V	A	A	V	ns	mJ	K/W		K/W	W		
IXGT 72N60B3	600	75	72	1.8	90	2.2	0.23			540	X019	X005a <b>TO-220AB</b>
IXGX 72N60A3H1		75	72	1.35	250	6.5	0.23	•	0.3	540	X015a	
IXGX 72N60B3H1		75	72	1.8	92	2.2	0.23	•	0.3	540	X015a	
IXGX 72N60C3H1		75	72	2.5	55	0.93	0.23	•	0.3	540	X015a	
IXGN 72N60C3H1		78	52	2.5	55	0.93	0.35	•	0.42	360	X027a	X011b <b>TO-263AB</b>
IXGH 36N60B3		92	36	1.8	100	1.5	0.5			250	X014a	
IXGH 56N60B3		130	56	1.8	95	2.2	0.375			330	X014a	
IXGL 200N60B3		150	90	1.5	183	4.2	0.31			400	X022a	
IXGH 56N60A3		150	56	1.35	315	6.75	0.375			330	X014a	X014a <b>TO-247AD</b>
IXGN 72N60A3		160	68	1.35	250	6.5	0.35			360	X027a	
IXGH 36N60B3D1		200	36	1.8	100	1.5	0.5	•	0.9	250	X014a	
IXGH 36N60B3D4		200	36	1.8	100	1.5	0.5	•	2.5	250	X014a	
IXGK 120N60A3		200	120	1.35	260	10.4	0.16			780	X020a	X015a <b>PLUS247</b>
IXGN 120N60A3		200	120	1.35	260	10.4	0.21			595	X027a	
IXGN 120N60A3D1		200	120	1.35	260	10.4	0.21	•	0.85	595	X027a	
IXGX 120N60A3		200	120	1.35	260	10.4	0.16			780	X015a	
IXGA 48N60B3		280	48	1.8	116	1.3	0.42			300	X011b	X016a <b>ISOPLUS247™</b>
IXGH 48N60B3		280	48	1.8	116	1.3	0.42			300	X014a	
IXGK 120N60B3		280	120	1.8	145	4.7	0.16			780	X020a	
IXGP 48N60B3		280	48	1.8	116	1.3	0.42			300	X005a	
IXGX 120N60B3		280	120	1.8	145	4.7	0.16			780	X015a	
IXGN 200N60B3		300	200	1.5	183	4.2	0.15			830	X027a	X019 <b>TO-268AA</b>
IXGK 320N60A3		320	210	1.25	740		0.125			1000	X020a	
IXGN 320N60A3		320	170	1.25	740		0.17			735	X027a	
IXGX 320N60A3		320	210	1.25	740		0.125			1000	X015a	
IXGH 56N60B3D1		350	56	1.8	95	2.2	0.375	•	1.5	330	X014a	X020a <b>TO-264</b>
IXGK 64N60B3D1		400	64	1.8	88	1.95	0.27	•	1.35	460	X020a	
IXGN 400N60A3		400	190	1.25	270		0.15			830	X027a	
IXGX 64N60B3D1		400	64	1.8	88	1.95	0.27	•	1.35	460	X015a	
MMIX 1G320N60B3		400	180	1.5	165	5.4	0.125			1000	X031a	X022a <b>ISOPLUS264™</b>
IXGN 400N60B3		430	200	1.4	125	4.25	0.125			1000	X027a	
IXGK 320N60B3		500		1.6	165	5.4	0.073			1700	X020a	
IXGX 320N60B3		500		1.6	165	5.4	0.073			1700	X015a	
IXGA 36N60A3			36	1.4	325	5.3	0.56			220	X011b	
IXGA 48N60A3			48	1.35	224	5.6	0.42			300	X011b	X027a <b>SOT-227B miniBLOC</b>
IXGH 36N60A3			36	1.4	325	5.3	0.56			220	X014a	
IXGH 48N60A3			48	1.35	2.24	5.6	0.42			300	X014a	
IXGH 48N60B3D1			48	1.8	116	1.3	0.42	•	1.5	300	X014a	
IXGH 64N60A3			64	1.35	222	6	0.27			460	X014a	
IXGH 64N60B3			64	1.8	88	1.95	0.27			460	X014a	
IXGP 36N60A3			36	1.4	325	5.3	0.56			220	X005a	X031a <b>SMPD-X</b>
IXGP 48N60A3			48	1.35	224	5.6	0.42			300	X005a	
IXGR 64N60A3			47	1.35	222	6.03	0.62			200	X016a	
IXGR 72N60A3			52	1.35	250	6.5	0.62			200	X016a	
IXGT 64N60A3			64	1.35	222	6	0.27			460	X019	
IXGT 64N60B3			64	1.8	88	1.95	0.27			460	X019	

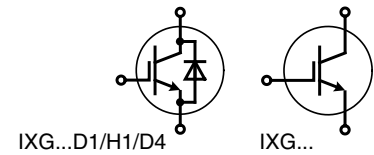

Part Type	V <sub>CES</sub>	I <sub>C</sub> T <sub>C</sub> = 25°C	I <sub>C</sub> T <sub>C</sub> = 110°C	V <sub>CE(sat)</sub> T <sub>C</sub> = 25°C	t <sub>fi</sub> typ T <sub>J</sub> = 25°C	E <sub>off</sub> typ T <sub>J</sub> = 125°C	R <sub>thJC</sub>	Diode	R <sub>thJC</sub> Diode	P <sub>C</sub>	Fig. No.	Package Style
➤ New	V	A	A	V	ns	mJ	K/W		K/W	W		Outline drawings on pages O-30...O-55
IXGH 32N100A3	1000	75	32	2.2	540	13	0.42			300	X014a	X005a <b>TO-220AB</b>
IXGT 32N100A3		75	32	2.2	540	13	0.42			300	X019	
IXGA 12N120A3	1200	22		3	1035		1.25			100	X011b	X011b <b>TO-263AB</b>
IXGH 12N120A3		22		3	1035		1.25			100	X014a	
IXGP 12N120A3		22		3	1035		1.25			100	X005a	
IXGA 20N120B3		36		3.1	155	1.63	0.69			180	X011b	X011b <b>TO-263AB</b>
IXGP 20N120B3		36		3.1	155	1.63	0.69			180	X005a	
IXGA 20N120A3		40	20	2.5	715	10.1	0.69			180	X011b	X014a <b>TO-247AD</b>
IXGH 20N120A3		40	20	2.5	715	10.1	0.69			180	X014a	
IXGP 20N120A3		40	20	2.5	715	10.1	0.69			180	X005a	
IXGH 30N120B3D1		50	30	3.5	204	5.1	0.42	•	0.9	300	X014a	X014a <b>TO-247AD</b>
IXGT 30N120B3D1		50	30	3.5	204	5.1	0.42	•	0.9	300	X019	
IXGA 30N120B3		60	30	3.5	204	5.1	0.42			300	X011b	X015a <b>PLUS247</b>
IXGH 30N120B3		60	30	3.5	204	5.1	0.42			300	X014a	
IXGP 30N120B3		60	30	3.5	204	5.1	0.42			300	X005a	
IXGR 55N120A3H1		70	30	2.35	282	29	0.62	•	0.42	200	X016a	X015a <b>PLUS247</b>
IXGH 32N120A3	75		2.35	1240		0.42			300	X014a		
IXGT 32N120A3	75	32	2.35	1240		0.42			300	X019	X016a <b>ISOPLUS247™</b>	
IXGK 55N120A3H1	125	55	2.3	282	29	0.27	•	0.42	460	X020a		
IXGX 55N120A3H1	125	55	2.3	282	29	0.27	•	0.42	460	X015a		
IXGN 82N120B3H1	145	64	3.2	100	7.1	0.21	•	0.42	595	X027a	X016a <b>ISOPLUS247™</b>	
IXGK 120N120B3	200		3	145	10.3	0.15			830	X020a		
IXGX 120N120B3	200		3	145	10.3	0.15			830	X015a	X016c <b>ISO247™</b>	
IXGK 82N120B3	230	82	3.2	100	7.1	0.1			1250	X020a		
IXGX 82N120B3	230	82	3.2	100	7.1	0.1			1250	X015a		
IXGK 120N120A3	240	120	2.2	325	58	0.15			830	X020a	X016c <b>ISO247™</b>	
IXGX 120N120A3	240	120	2.2	325	58	0.15			830	X015a		
IXGK 82N120A3	260	82	2.05	780	22.5	0.1			1250	X020a	X017a <b>TO-3P</b>	
IXGX 82N120A3	260	82	2.05	780	22.5	0.1			1250	X015a		

## G-Series B4, C4 IGBTs

Part Type	V <sub>CES</sub>	I <sub>C</sub> T <sub>C</sub> = 25°C	I <sub>C</sub> T <sub>C</sub> = 110°C	V <sub>CE(sat)</sub> T <sub>C</sub> = 25°C	t <sub>fi</sub> typ T <sub>J</sub> = 25°C	E <sub>off</sub> typ T <sub>J</sub> = 125°C	R <sub>thJC</sub>	Diode	I <sub>F110</sub> Diode T <sub>C</sub> = 110°C	R <sub>thJC</sub> Diode	P <sub>C</sub>	Fig. No.	Package Style
➤ New	V	A	A	V	ns	mJ	K/W		A	K/W	W		
IXGJ 50N60C4D1	600	52	21	2.5	63	0.9	1	•	12	2	125	X016c	X019 <b>TO-268AA</b>
IXGH 24N60C4		56	24	2.7	68	0.5	0.65				190	X014a	X020a <b>TO-264</b>
IXGH 24N60C4D1		56	24	2.7	68	0.5	0.65	•	18	1.6	190	X014a	
IXGP 24N60C4		56	24	2.7	68	0.5	0.65				190	X005a	X027a <b>SOT-227B miniBLOC</b>
IXGP 24N60C4D1		56	24	2.7	44	0.52	0.65	•	30	2.5	190	X005a	
IXGP 30N60B4D1		56	30	1.7	88	1.5	0.66	•	10	2.5	190	X005a	X017a <b>TO-3P</b>
IXGH 30N60B4		66	30	1.7	88	1.5	0.66				190	X014a	
IXGA 50N60C4		90	46	2.3	63	0.9	0.42				300	X011b	X017a <b>TO-3P</b>
IXGH 50N60C4		90	46	2.3	63	0.9	0.42				300	X014a	
IXGH 50N60C4D1		90	46	2.3	63	0.9	0.42	•	18	1.6	300	X014a	X017a <b>TO-3P</b>
IXGP 50N60C4		90	46	2.3	63	0.9	0.42				300	X005a	
IXGQ 50N60C4D1		90	46	2.3	63	0.9	0.42	•	18	1.6	300	X017a	X017a <b>TO-3P</b>
IXGA 50N60B4		100	50	1.8	80	1.9	0.42				300	X011b	
IXGH 50N60B4		100	50	1.8	80	1.9	0.42				300	X014a	X017a <b>TO-3P</b>
IXGH 50N60B4D1		100	50	1.8	80	1.9	0.42	•	18	1.6	300	X014a	
IXGP 50N60B4		100	50	1.8	80	1.9	0.42				300	X005a	X017a <b>TO-3P</b>
IXGQ 50N60B4D1		100	50	1.8	80	1.9	0.42	•	18	1.6	300	X017a	



# Fast PT IGBTs with SiC Anti-Parallel Diode

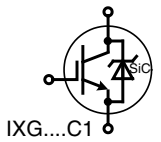

IXG...C1

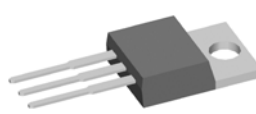
Part Type	$V_{CES}$	$I_c$ $T_c = 25^\circ\text{C}$	$I_c$ $T_c = 110^\circ\text{C}$	$V_{CE(sat)}$ $T_c = 25^\circ\text{C}$	$t_{fi}$ typ $T_J = 25^\circ\text{C}$	$E_{off}$ typ $T_J = 125^\circ\text{C}$	$R_{thJC}$	Diode	$I_{F110}$ Diode $T_c = 110^\circ\text{C}$	$R_{thJC}$ Diode	$P_c$	Fig. No.	Package Style
➤ New	V	A	A	V	ns	mJ	K/W		A	K/W	W		Outline drawings on pages O-30...O-55
➤ IXGA 30N60C3C1	600	60	30	3.0	47	0.33	0.56	•	13	1.1	220	X011b	 <p><b>TO-220AB</b></p>
➤ IXGH 30N60C3C1		60	30	3.0	47	0.33	0.56	•	13	1.1	220	X014a	
➤ IXGP 30N60C3C1		60	30	3.0	47	0.33	0.56	•	13	1.1	220	X005a	
➤ IXGR 60N60C3C1		75	30	2.5	50	0.80	0.73	•	13	1.75	170	X016a	
➤ IXGH 36N60B3C1		75	36	1.8	100	1.50	0.50	•	20	0.9	250	X014a	
➤ IXGR 60N60C2C1		75	39	2.7	54	1.20	0.50	•	14	1.75	250	X016a	
➤ IXGH 48N60B3C1		75	48	1.8	116	1.30	0.42	•	20	0.9	300	X014a	
➤ IXGH 48N60C3C1		75	48	2.5	38	0.57	0.42	•	20	0.9	300	X014a	

## High Voltage NPT IGBTs

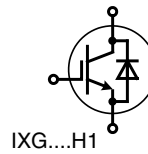

1600/1700 V Low On-State Voltage NPT IGBTs

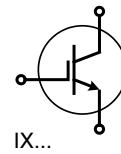

IXG...H1

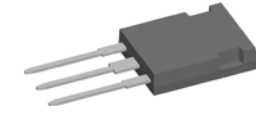

IX...

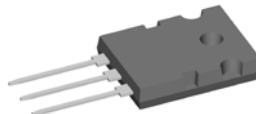
Part Type	$V_{CES}$	$I_c$ $T_c = 25^\circ\text{C}$	$I_c$ $T_c = 90^\circ\text{C}$ (110°C)	$V_{CE(sat)}$ $T_c = 25^\circ\text{C}$	$E_{off}$ typ $T_J = 125^\circ\text{C}$	$R_{thJC}$	Diode	Fig. No.	Package Style
	V	A	A	V	mJ	K/W			
IXGH 25N160	1600	75	(25)	2.5		0.42		X014a	 <p><b>ISOPLUS247™</b></p>
IXGT 25N160		75	(25)	2.7		0.42		X019	
IXGR 50N160H1		75	(36)	2.3		0.52	•	X016a	
IXGH 6N170	1700	12	6	4.0	2	1.65		X014a	 <p><b>TO-268AA</b></p>
IXGT 6N170		12	6	4.0	2	1.65		X019	
IXGH 10N170		20	10	4.0		1.10		X014a	
IXGT 10N170		20	10	4.0		1.10		X019	
IXGH 16N170		32	16	3.5	11.2	0.65		X014a	
IXGT 16N170		32	16	3.5	11.2	0.65		X019	
IXGR 32N170H1		38	20	3.5	13.6	0.65	•	X016a	X020a <b>TO-264</b>
IXGF 32N170		44	(19)	3.5	13.5	0.62		X024c	 <p><b>ISOPLUS i4-PAC™</b></p>
IXGH 24N170		50	24	3.3	12	0.5		X014a	
IXGT 24N170		50	24	3.3	12	0.5		X019	
IXGH 32N170		75	32	3.3	14	0.35		X014a	
IXGT 32N170		75	32	3.3	14	0.35		X019	
IXGX 32N170H1		75	32	3.3	22	0.35	•	X015a	
IXGN 100N170		160	95	3.0		0.17		X027a	
IXGX 100N170		170	100	3.0		0.15		X015a	
IXGK 100N170		170	100	3.0		0.15		X020a	

# High Voltage NPT IGBTs

## 1700 V NPT IGBTs

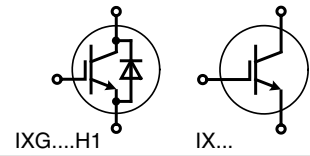

Part Type	V <sub>CES</sub>	I <sub>C</sub> T <sub>C</sub> = 25°C	I <sub>C</sub> T <sub>C</sub> = 90°C (110°C)	V <sub>CE(sat)</sub> T <sub>C</sub> = 25°C	t <sub>fi</sub> typ T <sub>J</sub> = 25°C	E <sub>off</sub> typ T <sub>J</sub> = 125°C	R <sub>thJC</sub>	Diode	I <sub>F90</sub> Diode T <sub>C</sub> = 90°C	R <sub>thJC</sub> Diode	Fig. No.	Package style
➤ New	V	A	A	V	ns	mJ	K/W		A	K/W		Outline drawings on pages O-30...O-55
IXGR 6N170A	1700	5.5	(2.5)	7	32	0.25	2.5				X016a	X013 <b>PLUS220 (SMD)</b>
IXGH 6N170A		6	3	7	32	0.26	1.65				X014a	
IXGT 6N170A		6	3	7	32	0.26	1.65				X019	
IXGH 10N170A		10	5	6	35	0.6	0.89				X014a	
IXGT 10N170A		10	5	6	35	0.6	0.89				X019	
IXGH 16N170A		16	11	5	70	2	0.65				X014a	
IXGH 16N170AH1		16	11	5	70	2	0.65	•	17	0.9	X014a	
IXGR 16N170AH1		16	8	5	40	1.1	1.04	•	15	1.5	X016a	
IXGT 16N170A		16	11	5	70	2	0.65				X019	
IXGT 16N170AH1		16	11	5	70	2	0.65	•	17	0.9	X019	X015a <b>PLUS247</b>
IXGH 24N170A		24	16	6	40	1.47	0.5				X014a	
IXGH 24N170AH1		24	16	6	40	1.47	0.5	•	16	0.9	X014a	
IXGT 24N170A		24	16	6	40	1.47	0.5				X019	
IXGT 24N170AH1		24	16	6	40	1.47	0.5	•	16	0.9	X019	
IXGR 32N170AH1		26	14	5.2	50	2.4	0.65	•	14	1.5	X016a	
IXGH 32N170A		32	21	5	50	2.4	0.35				X014a	
IXGT 32N170A		32	21	5	50	2.4	0.35				X019	
IXGX 32N170AH1		32	21	5	50	1.7	0.35	•	18	0.35	X015a	

# Very High Voltage NPT IGBTs



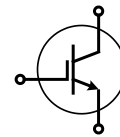



## 2.5 kV - 4 kV NPT IGBT

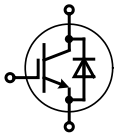

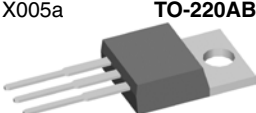
Part Type	V <sub>CES</sub>	I <sub>C25</sub> T <sub>C</sub> = 25°C	I <sub>C110</sub> T <sub>C</sub> = 110°C (90°C)	V <sub>CE(sat)</sub> T <sub>C</sub> = 25°C	t <sub>fi</sub> typ T <sub>J</sub> = 25°C	E <sub>off</sub> typ T <sub>J</sub> = 125°C	R <sub>thJC</sub>	P <sub>C</sub>	Fig. No.	Package style
➤ New	V	A	A	V	ns	mJ	K/W	W		
IXGH 2N250	2500	5.5	2	3.1	100		3.90	32	X014a	
IXGT 2N250		5.5	2	3.1	100		3.90	32	X019	
IXGH 4N250C		13	4	6.0	29	0.8	0.82	150	X014a	
IXGT 4N250C		13	4	6.0	29	0.8	0.82	150	X019	
IXGF 20N250		23	(14)	3.1	930		1.25	100	X024c	
➤ IXGA 20N250HV		30	12	3.1	930		0.83	150	X011c	
IXGF 25N250		30	15	2.9	200		1.10	114	X024c	
IXLF 19N250A		32	19	3.9	250	30	0.50	250	X024c	
IXGH 25N250		60	25	2.9	200		0.50	250	X014a	
IXGT 25N250		60	25	2.9	200		0.50	250	X019	
➤ IXGT 25N250HV		60	25	2.9	200		0.50	250	X019a	
IXGL 75N250		110	(65)	2.9	455		0.29	430	X022e	
IXGK 75N250		170	75	2.7	455		0.16	780	X020a	
IXGX 75N250		170	75	2.7	455		0.16	780	X015a	
IXGH 10N300	3000	18	(10)	3.5	530		1.25	100	X014a	
IXGF 20N300		22	(14)	3.2	210		1.25	100	X024c	
IXGF 25N300		27	(16)	3.0	500		1.10	114	X024c	
IXGF 36N300		36	18	2.7	540		0.78	160	X024c	
IXGF 30N400	4000	30	15	3.1	514		0.78	160	X024c	
IXEL 40N400		90	40	3.5	425	205	0.26	380	X022e	
➤ IXA 40I4000KN		90	40	3.2	*	135	0.26	380	X022e	

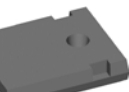
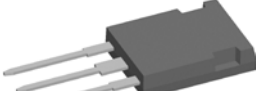
# BiMOSFETs (Monolithic Bipolar MOS Transistors)

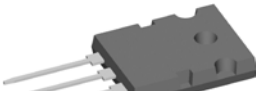
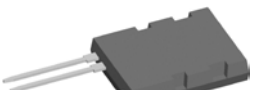
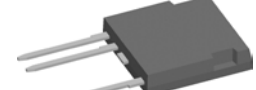

Type	V <sub>CES</sub>	I <sub>C25</sub> T <sub>C</sub> = 25°C	I <sub>C90</sub> T <sub>C</sub> = 90°C (110°C)	V <sub>CE(sat)</sub> typ (max) T <sub>C</sub> = 25°C (110°C)	Q <sub>G</sub> typ	t <sub>f</sub> typ T <sub>C</sub> = 125°C	R <sub>thJC</sub> max.	Fig. No.	Package style	
➤ New	V	A	A	V	nC	ns	K/W		Outline drawings on pages O-30...O-55	
IXBH 5N160G	1600	5.7	3.5	4.9	26	70	1.85	X014a	X005a <b>TO-220AB</b> 	
IXBP 5N160G		5.7	3.5	4.9	26	70	1.85	X005a		
IXBF 9N160G		7	5	4.9	34	70	1.75	X024c		
IXBH 9N160G		9	5	4.9	34	70	1.25	X014a		
IXBF 40N160		28	16	6.2	130	40	0.5	X024c		
IXBH 40N160	33	20	6.2	130	40	0.35	X014a	X011c <b>TO-268AA</b> 		
IXBH 6N170	1700	12	6	2.84	17	600	1.65	X014a	X014a <b>TO-247AD</b> 	
IXBT 6N170		12	6	2.84	17	600	1.65	X019		
IXBH 10N170		16	10	2.3	15	1200	1.25	X014a		
IXBH 16N170A		16	10	4.7	15	50	0.83	X014a		
IXBT 10N170		16	10	2.3	15	1200	1.25	X019		
IXBT 16N170A		16	10	4.7	15	50	0.83	X019		
IXBN 42N170A		38	21	6	15	50	0.4	X027a		
IXBH 16N170		40	16	3.3	15	705	0.5	X014a		
IXBT 16N170		40	16	3.3	15	705	0.5	X019		
IXBH 42N170A		42	21	6	15	50	0.35	X014a		
IXBT 42N170A		42	21	6	15	50	0.35	X019		
IXBR 42N170		57	32	2.9		740	0.62	X016a		X016a <b>ISOPLUS247™</b> 
IXBH 24N170		60	24	2.5	15	750	0.5	X014a		
IXBT 24N170		60	24	2.5	15	750	0.5	X019		
IXBN 75N170A		75	42	6			0.2	X027a		
IXBH 42N170		80	42	2.8	15	740	0.35	X014a		
IXBT 42N170		80	42	2.8	15	740	0.35	X019		
IXBK 75N170A		110	65	6			0.12	X020a		
IXBX 75N170A		110	65	6			0.12	X015		
IXBN 75N170		145	75	3.1		440	0.2	X027a		
IXBK 75N170	200		3.1			0.12	X020a			
IXBX 75N170	200		3.1			0.12	X015	X019a <b>TO-268AA</b> 		
IXBH 2N250	2500	5		3.5	15	182	3.9	X014a	X020a <b>TO-264</b> 	
IXBT 2N250		5		3.5	15	182	3.9	X019		
IXBX 25N250		55	25	3.3	103	510	0.42	X015		
IXCH 36N250		73	(36)	2.6	177	900	0.21	X014a		
IXCK 36N250		73	(36)	2.6	177	900	0.21	X020a		
IXBL 64N250	116		3		170	0.25	X022e	X022e <b>ISOPLUS264™</b> 		
IXBK 64N250	156		3		170	0.17	X020a	X024c <b>ISOPLUS i4-PAC™</b> 		
IXBX 64N250	156		3		170	0.17	X015			
IXBF 12N300	3000	26	(11)	2.8	62	530	1		X024c	
➤ IXBA 12N300HV		30	(12)	2.8	62	530	0.78		X011c	
IXBH 12N300		30	(12)	2.8	62	530	0.78		X014a	
IXBT 12N300		30	(12)	2.8	62	530	0.78		X019	
➤ IXBT 12N300HV		30	(12)	2.8	62	530	0.78		X019a	
IXBF 20N300	34	(14)	2.7	105	395	0.83	X024c		X027a <b>SOT-227B miniBLOC</b> 	
IXBF 32N300	40	22	2.8	142	630	0.78	X024c			
IXBH 20N300	50	(20)	2.7	105	395	0.5	X014a			
IXBT 20N300	50	(20)	2.7	105	395	0.5	X019			
➤ IXBT 20N300HV	50	(20)	2.7	105	395	0.5	X011c			
IXBF 42N300	60	(24)	2.5	200	490	0.52	X024c			
IXBH 32N300	80	(32)	2.8	142	630	0.31	X014a			
IXBT 32N300	80	(32)	2.8	142	630	0.31	X019			
IXBF 55N300	86	(34)	2.7	335	260	0.35	X024c			
➤ IXBT 42N300HV	104	(42)	2.5	200	490	0.25	X011c			
IXBK 55N300	130	(55)	2.7	335	260	0.2	X020a			
IXBX 55N300	130	(55)	3.2	335	260	0.2	X015			

# IGBT Modules – CBI Configuration

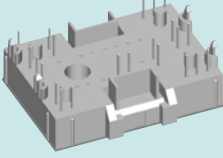
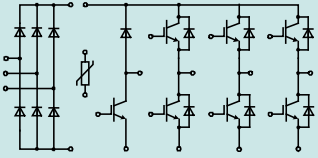
<b>CBI</b>  <b>X110 MiniPack2</b> Outline drawings on pages O-30...O-55 See data sheet for pin arrangement 												
Type	Rectifier 3~			Inverter 3~					Brake chopper			
	$V_{RRM}$	$I_{DAVM}$ $T_H = 80^\circ\text{C}$	$R_{thJC}$ typ.	$V_{CES}$	$I_C$ $T_C = 25^\circ\text{C}$	$I_C$ $T_C = 80^\circ\text{C}$	$V_{CE(sat)}$ typ.	$R_{thJC}$ typ.	$V_{CES}$	$I_C$ $T_C = 80^\circ\text{C}$	$R_{thJC}$ typ.	
➤ New	V	A	K/W	V	A	A	V	K/W	V	A	K/W	
<b>600 V NPT IGBT</b>												
MIAA 10WB600TMH	1600	62	2.1	600	18	13	2.1	1.8	600	13	1.8	
MIAA 10WF600TMH	1600	62	2.1	600	18	13	2.1	1.8	no brake chopper included			
MIAA 15WB600TMH	1600	62	2.1	600	23	16	2.1	1.6	600	16	1.6	
MIAA 20WB600TMH	1600	62	2.1	600	29	20	2.1	1.3	600	20	1.3	
<b>600 V Trench IGBT</b>												
➤ MITA 30WB600TMH	1600	89	1.4	600	40	27	1.5	1.4	600	27	1.4	
<b>1200 V Trench IGBT</b>												
MITA 10WB1200TMH	1600	61	2.1	1200	17	12	1.9	1.9	1200	12	1.9	
MITA 15WB1200TMH	1600	62	2.1	1200	30	21	1.8	1.1	1200	21	1.1	
MITB 10WB1200TMH	1600	61	2.1	1200	17	12	1.9	1.9	1200	12	1.9	
MITB 15WB1200TMH	1600	61	2.1	1200	29	20	1.7	1.2	1200	20	1.2	
<b>1200 V XPT IGBT</b>												
MIXA 10WB1200TMH	1600	69	1.8	1200	17	12	1.8	2.0	1200	12	2.0	
MIXA 20WB1200TMH	1600	69	1.8	1200	28	20	1.8	1.26	1200	20	1.26	

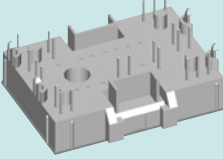
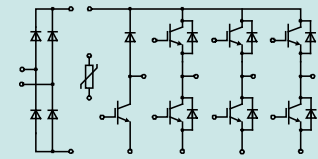
<b>CBI</b>  <b>X110 MiniPack2</b> Outline drawings on pages O-30...O-55 See data sheet for pin arrangement 												
Type	Rectifier 1~			Inverter 3~					Brake chopper			
	$V_{RRM}$	$I_{DAVM}$ $T_H = 80^\circ\text{C}$	$R_{thJC}$ typ.	$V_{CES}$	$I_C$ $T_C = 25^\circ\text{C}$	$I_C$ $T_C = 80^\circ\text{C}$	$V_{CE(sat)}$ typ.	$R_{thJC}$ typ.	$V_{CES}$	$I_C$ $T_C = 80^\circ\text{C}$	$R_{thJC}$ typ.	
➤ New	V	A	K/W	V	A	A	V	K/W	V	A	K/W	
<b>600 V NPT IGBT</b>												
MIAA 10WE600TMH	1600	23	2.1	600	18	13	2.1	1.8	600	13	1.8	
MIAA 10WD600TMH	1600	23	2.1	600	18	13	2.1	1.8	no brake chopper included			
MIAA 15WE600TMH	1600	23	2.1	600	23	16	2.1	1.6	600	16	1.6	
MIAA 15WD600TMH	1600	23	2.1	600	23	16	2.1	1.6	no brake chopper included			
MIAA 20WE600TMH	1600	23	2.1	600	29	20	2.1	1.3	600	20	1.3	
MIAA 20WD600TMH	1600	23	2.1	600	29	20	2.1	1.3	no brake chopper included			

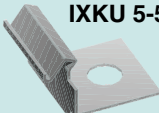
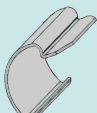
<b>Mechanical mounting part</b>  <b>IXKU 5-505</b>  <b>IXRB 5-506</b>	
IXKU 5-505	Screw clip
IXRB 5-506	Click clip

# IGBT Modules – CBI Configuration

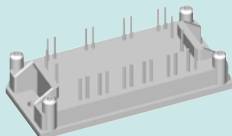
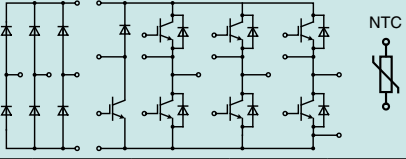
<b>CBI 1</b> IGBT Modules				<b>X111 E1-Pack</b> Outline drawings on pages O-30...O-55 See data sheet for pin arrangement							
Type	Rectifier 3~			Inverter 3~				Brake chopper			
➤ New	$V_{RRM}$ V	$I_{DAVM}$ $T_C = 80^\circ\text{C}$ A	$R_{thJC}$ typ. K/W	$V_{CES}$ V	$I_C$ $T_C = 25^\circ\text{C}$ A	$I_C$ $T_C = 80^\circ\text{C}$ A	$V_{CE(sat)}$ typ. V	$R_{thJC}$ typ. K/W	$V_{CES}$ V	$I_C$ $T_C = 80^\circ\text{C}$ A	$R_{thJC}$ typ. K/W
<b>600 V NPT IGBT</b>											
MUBW 10-06A6K	1600	61	2.10	600	12	8	2.5	2.80	600	8	2.80
MUBW 15-06A6K		65	1.90		19	14	2.4	1.70		8	2.80
MUBW 20-06A6K		65	1.90		25	17	2.0	1.50		8	2.80
MUBW 25-06A6K		65	1.90		31	21	2.1	1.25		14	1.70
MUBW 35-06A6K		89	1.40		42	29	2.3	0.95		17	1.50
<b>1200 V NPT IGBT</b>											
MUBW 15-12A6K	1600	89	1.40	1200	19	13	3.0	1.35	1200	13	1.35
MUBW 30-12A6K		89	1.40		30	21	3.0	0.95		13	1.35
<b>1200 V Trench IGBT</b>											
MUBW 45-12T6K	1600	104	1.10	1200	43	31	2.5	0.80	1200	13	1.35
<b>1200 V XPT IGBT</b>											
➤ MIXA 10WB1200TML	1600	69	1.80	1200	17	12	1.8	2.00	1200	12	2.00
➤ MIXA 20WB1200TML		105	1.10		28	20	1.8	1.26		12	2.00

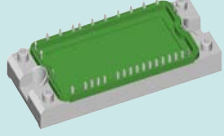
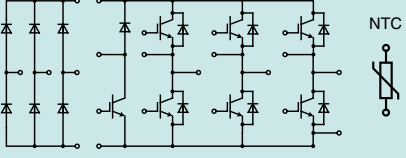
<b>CBI 2</b> IGBT Modules				<b>X112 E2-Pack</b> Outline drawings on pages O-30...O-55 See data sheet for pin arrangement							
Type	Rectifier 3~			Inverter 3~				Brake chopper			
➤ New	$V_{RRM}$ V	$I_{DAVM}$ $T_C = 80^\circ\text{C}$ A	$R_{thJC}$ typ. K/W	$V_{CES}$ V	$I_C$ $T_C = 25^\circ\text{C}$ A	$I_C$ $T_C = 80^\circ\text{C}$ A	$V_{CE(sat)}$ typ. V	$R_{thJC}$ typ. K/W	$V_{CES}$ V	$I_C$ $T_C = 80^\circ\text{C}$ A	$R_{thJC}$ typ. K/W
<b>600 V NPT IGBT</b>											
MUBW 10-06A7	1600	18	1.5	600	20	15	1.9	1.5	600	15	1.5
MUBW 15-06A7		18	1.5		25	18	1.9	1.3		15	1.5
MUBW 20-06A7		24	1.3		35	25	1.9	1.0		18	1.4
MUBW 30-06A7		24	1.3		50	35	1.9	0.7		18	1.3
MUBW 50-06A7		29	1.1		75	50	1.9	0.5		25	1.0
<b>600 V XPT IGBT</b>											
➤ MIXA 50WB600TED	1200	119	1.2	600	64	43	1.6	0.8	600	20	1.26
<b>1200 V NPT IGBT</b>											
MUBW 10-12A7	1600	18	1.5	1200	20	15	2.3	1.2	1200	15	1.2
MUBW 15-12A7		24	1.3		35	25	2.0	0.7		15	1.2
MUBW 25-12A7		24	1.3		50	35	2.2	0.55		15	1.2
MUBW 35-12A7		29	1.1		50	35	2.5	0.55		25	0.7
<b>1200 V Trench IGBT</b>											
MUBW 15-12T7	1600	24	1.3	1200	25	15	1.7	1.2	1200	15	1.2
MUBW 25-12T7		24	1.3		40	25	1.7	0.8		15	1.2
MUBW 40-12T7		29	1.1		62	44	2.0	0.6		25	0.7
<b>1200 V XPT IGBT</b>											
➤ MIXA 10WB1200TED	1600	105	1.1	1200	17	12	1.8	2.0	1200	12	2.0
➤ MIXA 20WB1200TED		105	1.1		28	20	1.8	1.26		12	2.0
➤ MIXA 30WB1200TED		105	1.1		43	30	1.8	0.84		12	2.0
➤ MIXA 40WB1200TED		105	1.1		50	40	1.8	0.64		20	1.26

# IGBT Modules – CBI Configuration

## CBI 3

IGBT Modules

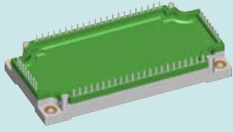

X113 E3-Pack

Outline drawings on pages O-30...O-55

See data sheet for pin arrangement

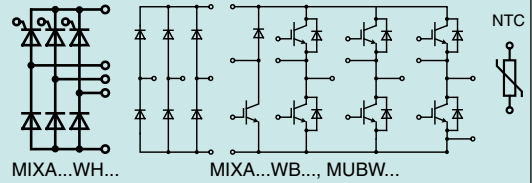

Type	Rectifier 3~			Inverter 3~					Brake chopper			Layout
	$V_{RRM}$	$I_{DAVM}$ $T_H = 80^\circ\text{C}$	$R_{thJC}$ typ.	$V_{CES}$	$I_C$ $T_C = 25^\circ\text{C}$	$I_C$ $T_C = 80^\circ\text{C}$	$V_{CE(sat)}$ typ.	$R_{thJC}$ typ.	$V_{CES}$	$I_C$ $T_C = 80^\circ\text{C}$	$R_{thJC}$ typ.	
➤ New	V	A	K/W	V	A	A	V	K/W	V	A	K/W	
<b>600 V NPT IGBT</b>												
MUBW 50-06A8	1600	40	1.10	600	75	50	1.9	0.50	600	25	1.00	A
MUBW 75-06A8		46	0.94		100	65	2.0	0.39		35	0.75	A
MUBW 100-06A8		60	0.73		125	85	1.9	0.30		50	0.55	A
<b>1200 V NPT IGBT</b>												
MUBW 35-12A8	1600	27	1.30	1200	50	35	2.5	0.55	1200	25	0.70	A
MUBW 50-12A8		46	0.94		85	60	2.2	0.35		35	0.55	A
<b>1200 V Trench IGBT</b>												
MUBW 50-12T8	1600	50	0.94	1200	75	50	1.7	0.45	1200	35	0.55	A
MUBW 75-12T8		50	0.94		105	75	1.7	0.35		35	0.55	A
<b>1200 V XPT IGBT</b>												
MIXA 60WB1200TEH	1600	190	0.65	1200	85	60	1.8	0.43	1200	40	0.64	A
➤ MIXA 60WH1200TEH <sup>1</sup>		135	0.65		85	60	1.8	0.43		40	0.64	C
MIXA 80WB1200TEH		265	0.50		120	84	1.8	0.32		40	0.64	A
➤ MIXA 81WB1200TEH		290	0.45		120	84	1.8	0.32		60	0.43	B
<b>1700 V Trench IGBT</b>												
MUBW 50-17T8	2200	120	1.10	1700	74	53	2.0	0.43	1700	34	0.62	A
MUBW 75-17T8		140	0.95		113	80	2.0	0.48		34	0.62	A

<sup>1</sup> input rectifier half-controlled

### Layout A

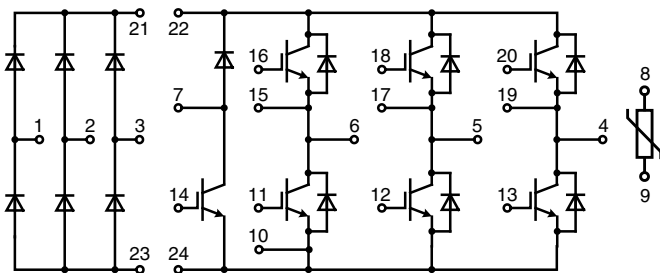

### Layout B

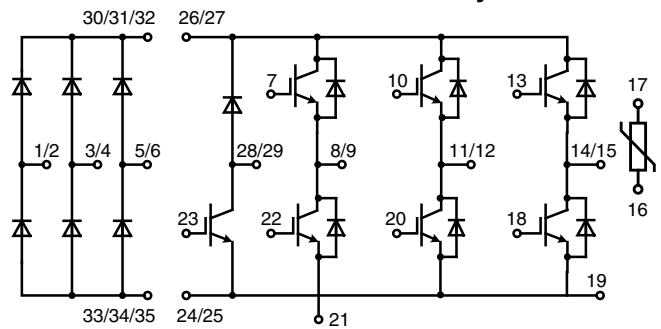

### Layout C

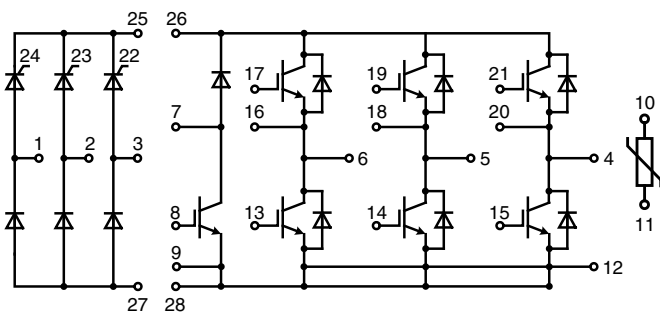

# IGBT Modules – Six-Pack Configuration

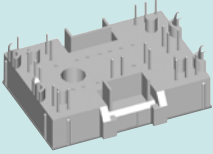
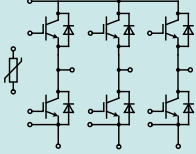
<b>Six-Pack</b> IGBT Modules				<b>X110 MiniPack2</b> Outline drawings on pages O-30...O-55 See data sheet for pin arrangement					
<b>Type</b>	$V_{CES}$	$I_{C25}$ IGBT $T_C = 25^\circ\text{C}$	$I_{C80}$ IGBT $T_C = 80^\circ\text{C}$	$V_{CE(sat)}$ typ IGBT $T_J = 25^\circ\text{C}$	$E_{off}$ IGBT $T_J = 125^\circ\text{C}$	$R_{thJC}$ IGBT	$I_{F25}$ Diode $T_C = 25^\circ\text{C}$	$I_{F80}$ Diode $T_C = 80^\circ\text{C}$	<b>NTC</b>
➤ <b>New</b>	V	A	A	V	mJ	K/W	A	A	
<b>1200 V XPT IGBT</b>									
<b>MIXA 10W1200TMH</b>	1200	17	12	1.8	1.1	2.00	19	13	•
<b>MIXA 20W1200TMH</b>		28	20	1.8	1.7	1.26	33	22	•
<b>MIXA 30W1200TMH</b>		43	30	1.8	3.0	0.84	44	29	•
<b>MIXA 40W1200TMH</b>		60	40	1.8	4.1	0.64	44	29	•

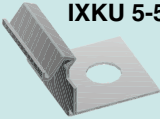
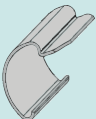
<b>Mechanical mounting part</b>					
<b>IXKU 5-505</b>	Screw clip				
<b>IXRB 5-506</b>	Click clip				

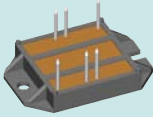
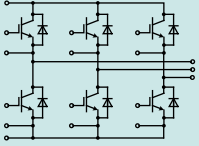
<b>Six-Pack</b> IGBT Modules				<b>X102 ECO-PAC2</b> Outline drawings on pages O-30...O-55 See data sheet for pin arrangement					
<b>1200 V XPT IGBT</b>									
<b>MIXA 20W1200MC</b>	1200	28	20	1.8	1.7	1.3	33	22	

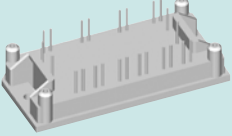
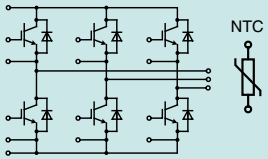
<b>Six-Pack</b> IGBT Modules				<b>X111 E1-Pack</b> Outline drawings on pages O-30...O-55 See data sheet for pin arrangement					
<b>Type</b>	$V_{CES}$	$I_{C25}$ IGBT $T_C = 25^\circ\text{C}$	$I_{C80}$ IGBT $T_C = 80^\circ\text{C}$	$V_{CE(sat)}$ typ IGBT $T_J = 25^\circ\text{C}$	$E_{off}$ IGBT $T_J = 125^\circ\text{C}$	$R_{thJC}$ IGBT	$I_{F25}$ Diode $T_C = 25^\circ\text{C}$	$I_{F80}$ Diode $T_C = 80^\circ\text{C}$	<b>NTC</b>
➤ <b>New</b>	V	A	A	V	mJ	K/W	A	A	
<b>1200 V NPT IGBT</b>									
<b>MWI 15-12A6K</b>	1200	19	13	3.0	1.1	1.37	24	16	•
<b>1200 V Trench IGBT</b>									
<b>MWI 45-12T6K</b>	1200	43	31	1.9	3.4	0.80	49	32	•
<b>MWI 60-12T6K</b>		58	41	1.9	4.8	0.62	49	32	•
<b>MWI 80-12T6K</b>		80	56	2.0	6.5	0.46	80	51	•
<b>1200 V XPT IGBT</b>									
<b>MIXA 10W1200TML</b>	1200	17	12	1.8	1.1	2.00	19	13	•
<b>MIXA 20W1200TML</b>		28	20	1.8	1.7	1.26	33	22	•
<b>MIXA 30W1200TML</b>		43	30	1.8	3.0	0.84	44	29	•
<b>MIXA 40W1200TML</b>		60	40	1.8	4.1	0.64	44	29	•

# IGBT Modules – Six-Pack configuration

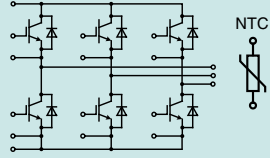
<b>Six-Pack</b> IGBT Modules		<b>X112 E2-Pack</b>									
		Outline drawings on pages O-30...O-55 See data sheet for pin arrangement									
Type	V <sub>CES</sub>	I <sub>C25</sub> IGBT T <sub>C</sub> = 25°C	I <sub>C80</sub> IGBT T <sub>C</sub> = 80°C	V <sub>CE(sat)</sub> typ IGBT T <sub>J</sub> = 25°C	E <sub>off</sub> IGBT T <sub>J</sub> = 125°C	R <sub>thJC</sub> IGBT	I <sub>F25</sub> Diode T <sub>C</sub> = 25°C	I <sub>F80</sub> Diode T <sub>C</sub> = 80°C	NTC	Layout	
➤ New	V	A	A	V	mJ	K/W	A	A			
<b>600 V NPT IGBT</b>											
MWI 30-06A7	600	45	30	1.9	1.0	0.88	36	24		A	
MWI 30-06A7T		45	30	1.9	1.0	0.88	36	24	•	A	
MWI 50-06A7		75	50	1.9	1.7	0.55	72	45		A	
MWI 50-06A7T		75	50	1.9	1.7	0.55	72	45	•	A	
MWI 75-06A7		90	60	2.1	2.5	0.44	140	85		A	
MWI 75-06A7T		90	60	2.1	2.5	0.44	140	85	•	A	
<b>650 V XPT TRENCH IGBT</b>											
➤ MIXA 50W650TED	650	*	50	1.5	1.2 (150°C)	*	*	*	•	B	
➤ MIXA 75W650TED		*	75	1.5	1.7 (150°C)	*	*	*	•	B	
<b>1200 V NPT IGBT</b>											
MWI 15-12A7	1200	30	20	1.0	1.8	0.88	25	17		A	
MWI 25-12A7		50	35	2.2	2.8	0.55	50	33		A	
MWI 25-12A7T		50	35	2.2	2.8	0.55	50	33	•	A	
MWI 35-12A7		62	44	2.2	4.2	0.44	50	33		A	
MWI 35-12A7T		62	44	2.2	4.2	0.44	50	33	•	A	
MWI 50-12A7		85	60	2.2	5.6	0.35	110	70		A	
MWI 50-12A7T		85	60	2.2	5.6	0.35	110	70	•	A	
<b>1200 V Trench IGBT</b>											
MWI 35-12T7T	1200	60	35	1.7	4.1	0.62	50	33	•	B	
MWI 50-12T7T		75	50	1.7	6.5	0.49	110	70	•	B	
MWI 75-12T7T		105	75	1.7	9.5	0.35	150	100	•	B	
<b>1200 V XPT IGBT</b>											
MIXA 30W1200TED	1200	43	30	1.8	3.0	0.84	44	29	•	B	
MIXA 40W1200TED		60	40	1.8	4.1	0.64	44	29	•	B	
MIXA 60W1200TED		85	60	1.8	5.5	0.43	88	59	•	B	
➤ MIXA 80W1200TED		120	84	1.8	8.3	0.32	135	90	•	B	

\* in progress

**Layout A (NTC option on some types)**

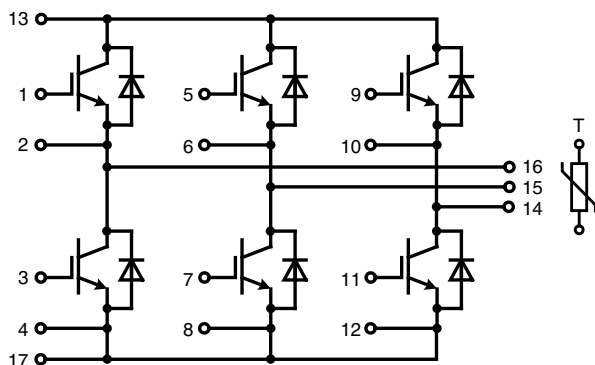

**Layout B**

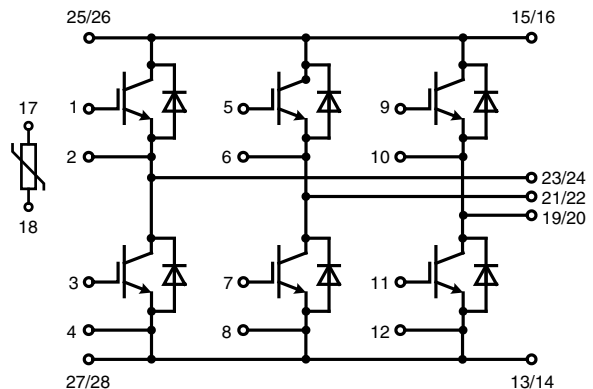

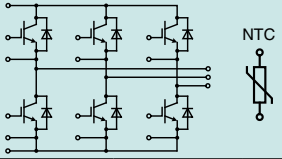

# IGBT Modules – Six-Pack configuration

<b>Six-Pack</b> IGBT Modules		<b>X113 E3-Pack</b> Outline drawings on pages O-30...O-55 See data sheet for pin arrangement									
Type	V <sub>CES</sub>	I <sub>C25</sub> IGBT T <sub>C</sub> = 25°C	I <sub>C80</sub> IGBT T <sub>C</sub> = 80°C	V <sub>CE(sat) typ</sub> IGBT T <sub>J</sub> = 25°C	E <sub>off</sub> IGBT T <sub>J</sub> = 125°C	R <sub>thJC</sub> IGBT	I <sub>F25</sub> Diode T <sub>C</sub> = 25°C	I <sub>F80</sub> Diode T <sub>C</sub> = 80°C	NTC	Layout	
➤ New	V	A	A	V	mJ	K/W	A	A			
<b>600 V NPT IGBT</b>											
MWI 100-06A8	600	130	88	2.0	2.9	0.30	140	88		A	
MWI 100-06A8T		130	88	2.0	2.9	0.30	140	88	•	A	
MWI 150-06A8		170	115	2.0	4.6	0.24	210	130		A	
MWI 150-06A8T		170	115	2.0	4.6	0.24	210	130	•	A	
MWI 200-06A8		215	155	2.0	6.3	0.18	260	165		A	
MWI 200-06A8T		215	155	2.0	6.3	0.18	260	165	•	A	
<b>650 V XPT TRENCH IGBT</b>											
➤ MIXD 200W650TEH	650	*	200	1.6	7.5 (150°C)	*	*	*	•	B	
<b>1200 V NPT IGBT</b>											
MWI 75-12A8	1200	125	85	2.2	10.5	0.25	150	100		A	
MWI 75-12A8T		125	85	2.2	10.5	0.25	150	100	•	A	
MWI 100-12A8		160	110	2.2	14.6	0.19	200	130		A	
MWI 100-12A8T		160	110	2.2	14.6	0.19	200	130	•	A	
<b>1200 V SPT+ IGBT</b>											
MIEB 100W1200TEH		183	128	1.8	9.7	0.20	135	90	•	B	
➤ MIEB 100W1200DPFTEH		183	128	1.8	9.7	0.20	135	90	•	B	
MIEB 101W1200EH		183	128	1.8	9.7	0.20	135	90		A	
➤ MIEB 101W1200DPFEH		183	128	1.8	9.7	0.20	135	90		A	
<b>1200 V Trench IGBT</b>											
MWI 75-12T8T	1200	100	75	1.7	9.5	0.35	150	100	•	B	
MWI 100-12T8T		140	100	1.7	12.0	0.26	200	130	•	B	
MWI 150-12T8T		200	150	1.7	17.0	0.18	196	132	•	B	
<b>1200 V XPT IGBT</b>											
➤ MIXA 80W1200TEH	1200	120	84	1.8	8.3	0.32	135	90	•	B	
➤ MIXA 100W1200TEH		155	108	1.8	11.0	0.25	135	90	•	B	
➤ MIXA 150W1200TEH		220	150	1.8	16.0	0.18	190	130	•	B	
<b>1700 V SPT+ IGBT</b>											
MWI 100-17E8T	1700	145	100	2.3	24.9	0.25	tbd	100	•	B	
MWI 150-17E8T		195	150	2.3	37.9	0.17	tbd	150	•	B	

\* in progress

**Layout A (NTC option on some types)**

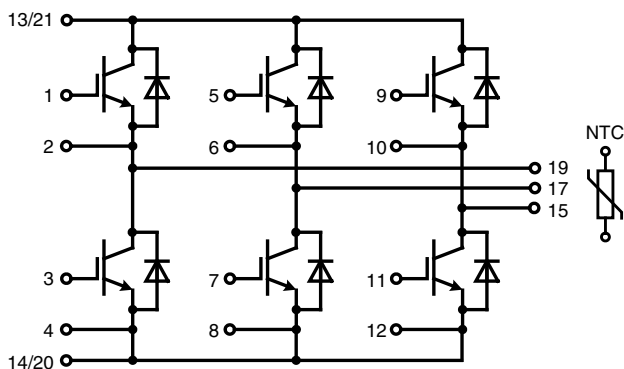

**Layout B**

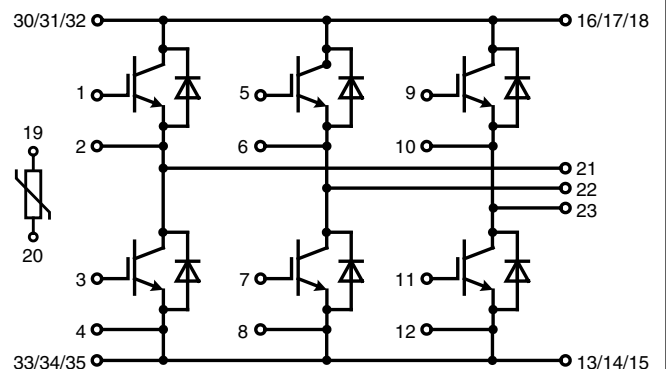

# IGBT Modules in MiniPack2B package

## MiniPack2B with PressFIT Pins

X109 MiniPack2B

Outline drawings on  
pages O-30...O-55

See data sheet for pin arrangement



### Multi Level Configuration

...PM...

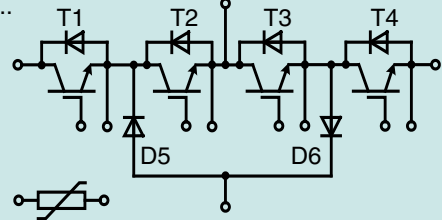

Type	$V_{RRM}$	IGBTs T1 & T4				IGBTs T2 & T3				Diodes D5 & D6			
		$I_C$ $T_C = 25^\circ\text{C}$	$I_C$ $T_C = 80^\circ\text{C}$	$V_{CE(sat)}$ typ.	$R_{thJC}$ typ.	$I_C$ $T_C = 25^\circ\text{C}$	$I_C$ $T_C = 80^\circ\text{C}$	$V_{CE(sat)}$ typ.	$R_{thJC}$ typ.	$I_D$ $T_C = 25^\circ\text{C}$	$I_D$ $T_C = 80^\circ\text{C}$	$V_F$ typ.	$R_{thJC}$ typ.
➤ New	V	A	A	V	K/W	A	A	V	K/W	A	A	V	K/W
➤ MIXA 50PM650TMI	650	75	50	1.6	0.8	75	50	1.6	0.8	55	40	1.8	1.2
➤ MIXA 100PM650TMI		150	100	1.6	0.35	150	100	1.6	0.35	130	100	1.8	0.6
➤ MIXD 80PM650TMI		108	82	1.5	0.55	147	110	1.5	0.40	114	83	1.7	0.6

### CBI Configuration

...WB...

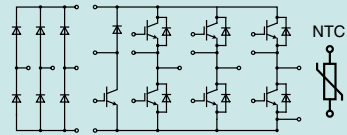

Type	Rectifier 3~			Inverter 3~					Brake chopper		
	$V_{RRM}$	$I_{DAVM}$ $T_C = 80^\circ\text{C}$	$R_{thJC}$ typ.	$V_{CES}$	$I_C$ $T_C = 25^\circ\text{C}$	$I_C$ $T_C = 80^\circ\text{C}$	$V_{CE(sat)}$ typ.	$R_{thJC}$ typ.	$V_{CES}$	$I_C$ $T_C = 80^\circ\text{C}$	$R_{thJC}$ typ.
➤ New	V	A	K/W	V	A	A	V	K/W	V	A	K/W
➤ MIXA 20WB1200TMI	1600	105	1.5	1200	28	20	1.8	1.26	1200	12	2.0
➤ MIXA 30WB1200TMI	1600	105	1.1	1200	43	30	1.8	0.84	1200	20	1.26

### Six-Pack Configuration

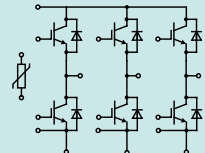

Type	$V_{CES}$	$I_{C25}$ IGBT $T_C = 25^\circ\text{C}$	$I_{C80}$ IGBT $T_C = 80^\circ\text{C}$	$V_{CE(sat)}$ typ IGBT $T_J = 25^\circ\text{C}$	$E_{off}$ IGBT $T_J = 125^\circ\text{C}$	$R_{thJC}$ IGBT	$I_{F25}$ Diode $T_C = 25^\circ\text{C}$	$I_{F80}$ Diode $T_C = 80^\circ\text{C}$	NTC
➤ New	V	A	A	V	mJ	K/W	A	A	
➤ MIXA 40W1200TMI	1200	60	40	1.8	4.1	0.64	44	29	•
➤ MIXA 60W1200TMI	1200	85	60	1.8	5.5	0.43	88	59	•

# IGBT XPT Modules in SimBus F package

- space savings
- reduced protection circuits
- package designed for wave soldering

**Package style**  
Outline drawings  
on pages  
O-30...O-55

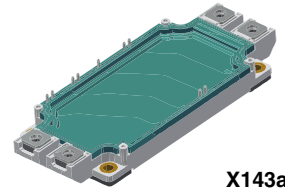

X143a

Type	$V_{CES}$	$I_{C80}$ IGBT	$V_{CE(sat)}$ typ IGBT	$E_{on}$ IGBT	$E_{off}$ IGBT	$R_{thJC}$ IGBT	$I_{F80}$ Diode	$R_{thJC}$ Diode	Fig. No.
New under development	V	$T_C = 80^\circ C$ A	$T_J = 25^\circ C$ V	$T_J = 125^\circ C$ mJ	$T_J = 125^\circ C$ mJ	K/W	$T_C = 80^\circ C$ A	K/W	
<b>Phase-Leg</b>									
➤ MIXA 600PF650TSF	650	490	1.65	6	23	0.085	340	0.095	X143a
➤ MIXA 225PF1200TSF	1200	250	1.80	20	27	0.115	185	0.145	
➤ MIXA 300PF1200TSF		325	1.80	20	42	0.085	185	0.145	
➤ MIXA 450PF1200TSF		450	1.80	22	68	0.060	265	0.095	
◇ MIXA 600PF1200TSF		600	1.80	*	*	*	*	*	
<b>1700 V XPT IGBT</b>									
◇ MIXA 225PF1700TSF	1700	355	250	*	*	*	*	•	
◇ MIXA 300PF1700TSF		425	300	*	*	*	*	•	
◇ MIXA 450PF1700TSF		635	450	*	*	*	*	•	
<b>Brake / Boost</b>									
➤ MIXA 225RF1200TSF	1200	250	1.80	20	27	0.115	185	0.145	
<b>Common Emitter</b>									
➤ MIXA 600AF650TSF	650	490	1.65	6	23	0.085	340	0.095	
<b>Common Collector</b>									
➤ MIXA 600CF650TSF	650	490	1.65	6	23	0.085	340	0.095	
<b>Multi Level (one half)</b>									
➤ MIXA 430LD1200TSF <sup>1</sup>	1200	430	1.80	34	44	0.064	265	0.110	
	650	345	1.65	6.5	15	0.100	200	0.145	

\* in progress    <sup>1</sup> two MIXA 430DL1200TSF build a T-type (NPC2 type) multi level circuit

...PF...  
phase-leg

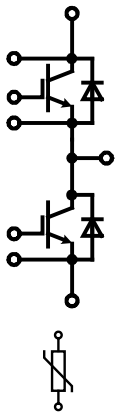

...RF...  
brake / boost

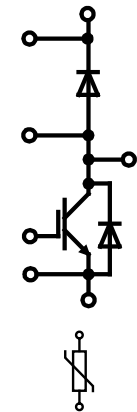

...AF...  
common emitter

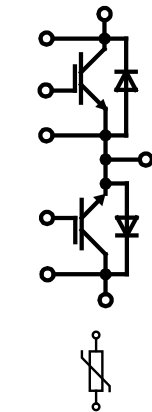

...CF...  
common collector

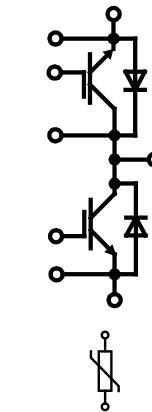

...LD...  
multi level (one half)

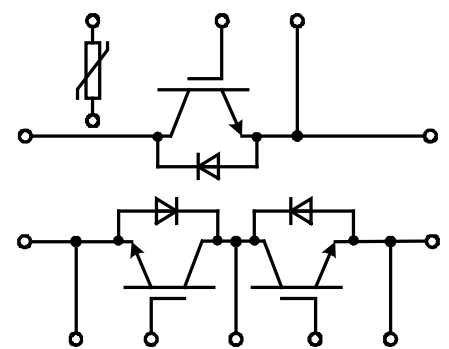

# IGBT Six-Pack and High Power Half Bridge Configuration

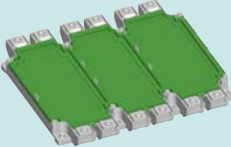
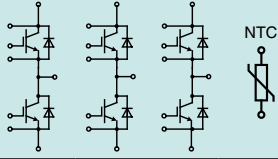
<b>Six-Pack</b> IGBT Modules				<b>X114 E9-Pack</b> Outline drawings on pages O-30...O-55 See data sheet for pin arrangement				NTC	
Type	$V_{CES}$	$I_{C25}$ IGBT $T_C = 25^\circ\text{C}$	$I_{C80}$ IGBT $T_C = 80^\circ\text{C}$	$V_{CE(sat)}$ typ IGBT $T_J = 25^\circ\text{C}$	$E_{off}$ IGBT $T_J = 125^\circ\text{C}$	$R_{thJC}$ IGBT	$I_{F80}$ Diode $T_C = 80^\circ\text{C}$	NTC	
◇ under development ➤ New	V	A	A	V	mJ	K/W	A		
<b>1200 V XPT IGBT</b>									
MIXA 225W1200TFH	1200	360	250	1.8	27	0.115	185	•	
MIXA 300W1200TFH		465	325	1.8	42	0.085	185	•	
MIXA 450W1200TFH		650	450	1.8	68	0.060	265	•	
◇ MIXA 600W1200TFH		860	600	1.8	*	*	*	•	
<b>1200 V SPT+ IGBT</b>									
➤ MIEB 300W1200TFH	1200	530	375	1.8	30	0.07	260	•	
➤ MIEB 450W1200TFH		*	*	*	*	*	*	•	
<b>1700 V Trench IGBT</b>									
MWI 450-17T9	1700	600	425	2.1	150	0.057	225	•	
<b>1700 V XPT IGBT</b>									
◇ MIXA 225W1700TFH	1700	355	250	*	*	*	*	•	
◇ MIXA 300W1700TFH		425	300	*	*	*	*	•	
◇ MIXA 450W1700TFH		635	450	*	*	*	*	•	
* in progress									

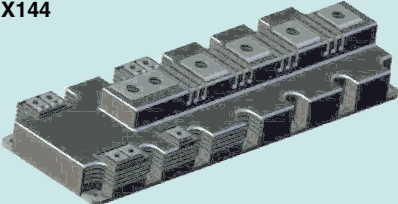
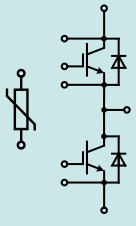
<b>XPT Half Bridge High Power Module</b> <i>in SimBus P package</i>		<b>X144</b>							
<ul style="list-style-type: none"> <li>• XPT IGBT and SONIC freewheeling diode</li> <li>• 175°C max junction temperature</li> <li>• Ultrasonic welded internal connections</li> <li>• Copper base plate</li> <li>• High reliability by optimized DCB substrates</li> </ul>		<b>Package style</b> Outline drawings on pages O-30...O-55							
Type	$V_{CES}$	$I_{C25}$ IGBT $T_C = 25^\circ\text{C}$	$I_{C80}$ IGBT $T_C = 80^\circ\text{C}$	$V_{CE(sat)}$ typ IGBT $T_J = 25^\circ\text{C}$	$E_{off}$ IGBT $T_J = 125^\circ\text{C}$	$R_{thJC}$ IGBT	$I_{F25}$ Diode $T_C = 25^\circ\text{C}$	$I_{F80}$ Diode $T_C = 80^\circ\text{C}$	Fig. No.
◇ under development	V	A	A	V	mJ	K/W	A	A	
◇ MIXA 1400PF1200TSP	1200	2100	1400	1.95	220	0.02	1650	1200	X144
◇ MIXA 1400PF1700TSP	1700	*	1400	*	*	*	*	*	
* in progress									

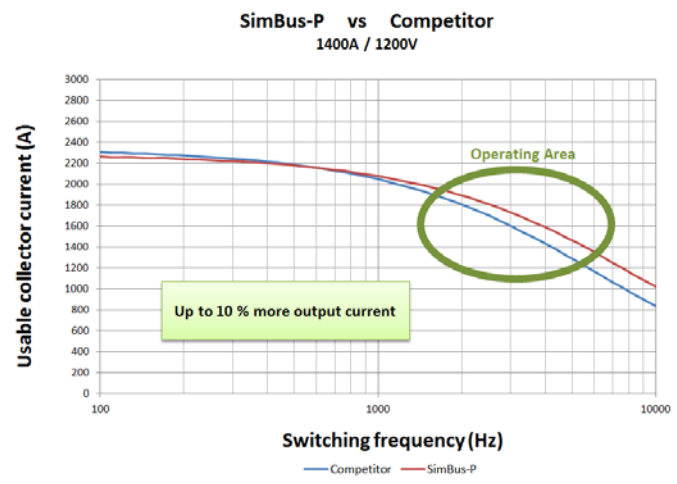

# IGBT Full Bridge and SOLAR Inverter Modules

<b>Full Bridge</b> IGBT Modules									
Type	Technology	$V_{CES}$	$I_{C25}$ IGBT $T_C = 25^\circ\text{C}$ A	$I_{C80}$ IGBT $T_C = 80^\circ\text{C}$ A	$V_{CE(sat)}$ typ IGBT $T_J = 25^\circ\text{C}$ V	$E_{off}$ IGBT $T_J = 125^\circ\text{C}$ mJ	$I_{F80}$ Diode $T_C = 80^\circ\text{C}$ A	NTC	Fig. No.
➤ New		V							
MKI 80-06T6K	Trench	600	89	67	1.8	2.8	67	•	X111
MKI 50-06A7	NPT	600	72	50	1.9	1.7	45	•	X112
MKI 50-06A7T			72	50	1.9	1.7	45		
MKI 65-06A7T			100	67	2.0	2.3	85		
MKI 75-06A7			90	60	2.5	6.3	85		
MKI 75-06A7T			90	60	2.5	6.3	85		
MKI 50-12F7	Fast NPT	1200	65	45	3.2	2.5	70		X113
MKI 100-12F8			65	45	3.2	2.5	70		
➤ MIXA 61H1200ED	XPT		85	60	1.8	5.5	59		X112
➤ MIXA 81H1200EH			120	84	1.8	8.3	90		
➤ MIEB 76H1200EH	SPT+	1200	128	90	2.3	7.0	90		X113
➤ MIEB 101H1200EH			183	128	1.8	9.7	90		

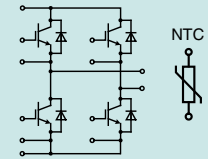

<b>SOLAR Inverter Modules</b>									
<b>NPT IGBT Full Bridge &amp; Boost Stage</b>									
Type	Technology	$V_{CES}$	$I_{C25}$ IGBT $T_C = 25^\circ\text{C}$ A	$I_{C80}$ IGBT $T_C = 80^\circ\text{C}$ A	$V_{CE(sat)}$ typ IGBT $T_J = 25^\circ\text{C}$ V	$E_{off}$ IGBT $T_J = 125^\circ\text{C}$ mJ	$I_{F80}$ Diode $T_C = 80^\circ\text{C}$ A	NTC	Fig. No.
➤ New		V							
➤ MWI 30-06A7 - S	NPT	600	45	30	1.9	1.0	24		X112
➤ MWI 50-06A7 - S			72	50	1.9	1.7	45		
<b>Fast XPT IGBT Full Bridge &amp; Boost Stage &amp; Bypass Diode</b>									
Type	Technology	$V_{CES}$	$I_{C25}$ IGBT $T_C = 25^\circ\text{C}$ A	$I_{C80}$ IGBT $T_C = 80^\circ\text{C}$ A	$V_{CE(sat)}$ typ IGBT $T_J = 25^\circ\text{C}$ V	$E_{on}$ IGBT $T_J = 150^\circ\text{C}$ mJ	$E_{off}$ IGBT $T_J = 150^\circ\text{C}$ mJ	$I_{F80}$ Diode $T_C = 80^\circ\text{C}$ A	Fig. No.
➤ New		V	A	A	V	mJ	mJ	A	
➤ MIXB 52HR600ED	fast XPT & SONIC	600	78	52	1.8	1.38	0.8	29	X112
➤ MIXB 52HR600DCGED	fast XPT & SiC		78	52	1.8	0.67	0.8	20	

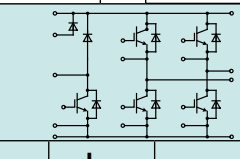
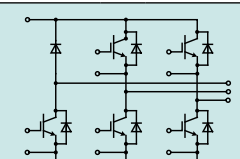

Outline drawings on pages O-30...O-55

X102 ECO-PAC2

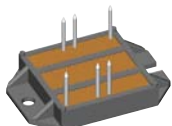

X111 E1-Pack

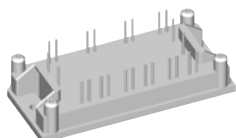

X112 E2-Pack

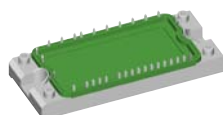



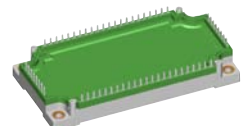

X113 E3-Pack

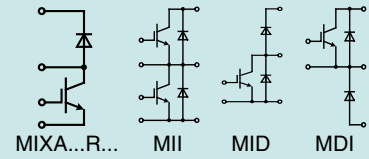

## NPT

IGBT Modules

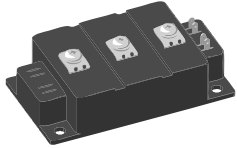

Type	V <sub>CES</sub>	I <sub>C25</sub> IGBT T <sub>C</sub> = 25°C	I <sub>C80</sub> IGBT T <sub>C</sub> = 80°C	V <sub>CE(sat)</sub> typ IGBT T <sub>J</sub> = 25°C	E <sub>off</sub> IGBT T <sub>J</sub> = 125°C	R <sub>thJC</sub> IGBT	I <sub>F25</sub> Diode T <sub>C</sub> = 25°C	I <sub>F80</sub> Diode T <sub>C</sub> = 80°C	Fig. No.	Package Style Outline drawings on pages O-30...O-55
➤ New	V	A	A	V	mJ	K/W	A	A		
<b>1200 V Half Bridge, NPT</b>										
MII 75-12A3	1200	90	60	2.2	5.6	0.33	100	60	X127a	X127a/b/c 
MII 100-12A3		135	90	2.2	10.5	0.22	150	100		
MII 145-12A3		160	110	2.2	15.0	0.18	150	100		
MII 150-12A4		180	120	2.2	11.5	0.17	200	130	X128a	
MII 200-12A4		270	180	2.2	21.0	0.11	300	200		
MII 300-12A4		330	220	2.2	29.0	0.09	450	270		
<b>1200 V Boost Chopper, NPT</b>										
MID 75-12A3	1200	90	60	2.2	5.6	0.33	100	60	X127b	X128a/b/c 
MID 100-12A3	1200	135	90	2.2	10.5	0.22	150	100		
MID 145-12A3		160	110	2.2	15.0	0.18	150	100		
MID 150-12A4		180	120	2.2	11.5	0.17	200	130	X128b	
MID 200-12A4		270	180	2.2	21.0	0.11	300	200		
MID 300-12A4		330	220	2.2	29.0	0.09	450	270		
MID 550-12A4		670	460	2.3	59.0	0.05	750	460		
<b>1200 V XPT IGBT Brake / Boost Chopper</b>										
➤ MIXA 80R1200VA	1200	120	84	1.9	8.3	0.32	135	90	X103	X130a/b/c 
➤ MIXA 150R1200VA		220	150	1.8	16	0.18	190	130		
<b>1200 V Buck Chopper, NPT</b>										
MDI 75-12A3	1200	90	60	2.2	5.6	0.33	100	60	X127c	X103 V1-Pack 
MDI 100-12A3		135	90	2.2	10.5	0.22	150	100		
MDI 145-12A3		160	110	2.2	15.0	0.18	150	100		
MDI 150-12A4		180	120	2.2	11.5	0.17	200	130	X128c	
MDI 200-12A4		270	180	2.2	21.0	0.11	300	200		
MDI 300-12A4		330	220	2.2	29.0	0.09	450	270		
MDI 550-12A4		670	460	2.3	59.0	0.05	750	460		
<b>1200 V XPT IGBT Buck Chopper</b>										
➤ MIXA 150Q1200VA	1200	220	150	1.8	16	0.18	190	130	X103	
<b>1200 V XPT IGBT Buck / Boost switched reluctance Chopper</b>										
➤ MIXA 60HU1200VA	1200	85	60	1.8	5.5	0.43	88	59	X103	

# Power MOSFETs and MOSFET Modules

The Metal Oxide Semiconductor Field Effect Transistor (MOSFET) is a transistor that is used for high frequency switching control of power electronic systems. IXYS offer various MOSFET technology based on the customer requirement for voltage, switching frequency. A table giving a diagrammatic representation of our basic MOSFET offerings is given below.

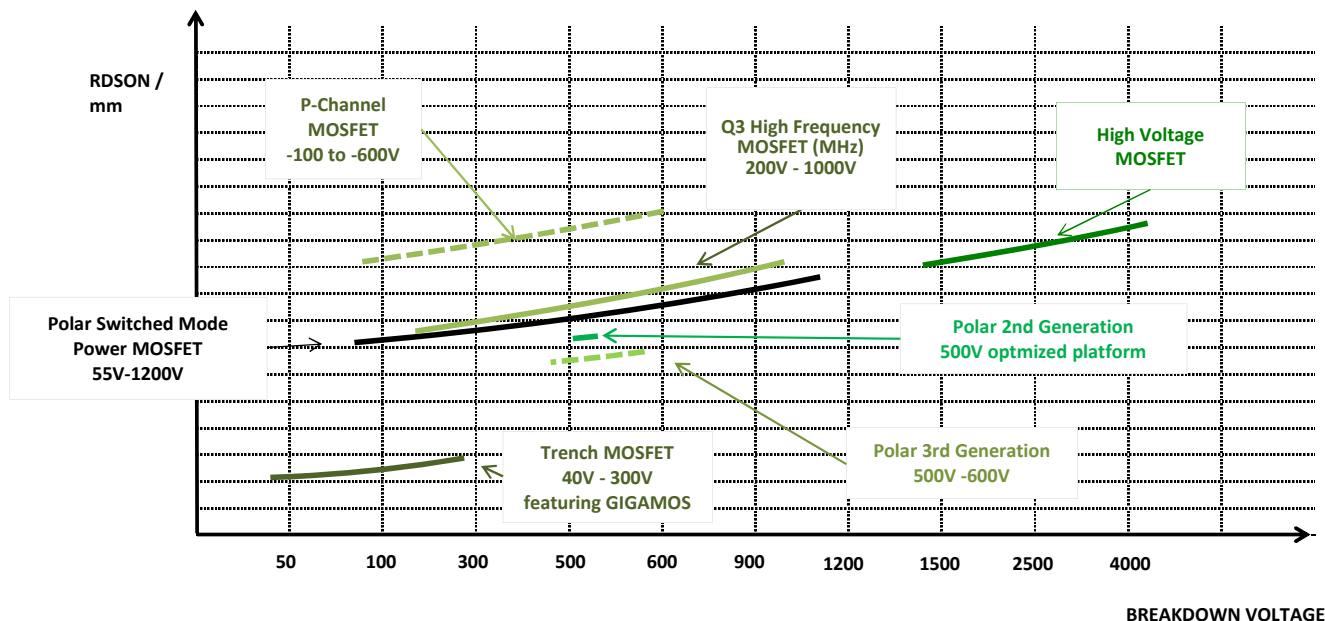

## Trench and Trench2 Power MOSFETs

IXYS Trench Power MOSFETs are ideally suited for low-voltage, high-current applications. These MOSFETs feature an exceptionally low  $R_{DS(on)}$ , thus guaranteeing low power dissipation. Trench HiPerFET™ versions feature all of the advantages presented by IXYS' Trench Standard Power MOSFETs with an added benefit of a fast intrinsic rectifier which provides low reverse recovery charge ( $Q_{rr}$ ) and excellent commutating  $dV/dt$  ratings for enhanced power switching capabilities and device ruggedness.

## Polar™ Power MOSFETs

Polar™ MOSFETs (IXT..) feature a proprietary cell design and process that has resulted in a MOSFET with a 30% reduction in  $R_{DS(on)}$  per unit area along with a decrease in gate charge. IXYS has also reduced the wafer thickness, which substantially reduces the thermal resistance. The combination of lower  $R_{DS(on)}$ , lower gate charge  $Q_g$  and higher power dissipation capability has resulted in a new class of MOSFETs, which will increase the cost effectiveness in switch mode power supply (SMPS) applications. IXYS' Polar™ HiPerFETs (IXF..) combine the strengths of the Polar Standard product family with a faster body diode, whose reverse recovery time ( $t_{rr}$ ) is reduced to make them suitable for phase-shift bridges, motor control and uninterruptible power supply applications (UPS). This family of HiPerFETs provide lowest  $R_{DS(on)}$ , low  $R_{thJC}$ , low  $Q_g$ , and enhanced  $DV/DT$  capability.

## PolarP2™ Power MOSFETs

PolarP2™ devices are an optimized range of the standard Polar platform for 500V device rating.

## PolarP3™ HiPerFET Power MOSFETs

The PolarP3™ HiPerFET product family is the latest addition to IXYS' benchmark high-performance Polar-Series product line for our product portfolio between 500V and 600V. Its high Figure of Merit (FOM) being the multiplication of  $Q_g$  and in  $R_{DS(on)}$  provide an excellent alternative to weaker super junction technologies. All IXYS Polar MOSFETs are tested 100% for avalanche energy providing the industries standard for reliability and ruggedness.

## Extended FBSOA Linear Power MOSFETs

IXYS' Extended FBSOA Linear Power MOSFETs are a class of rugged Power MOSFETs tailored specifically for applications that require Power MOSFETs to operate in their current saturation region. These new devices feature low static drain to source on-resistances and provide unparalleled performance and reliability in controlled current output applications. Typical applications that stand to benefit from this new class of extended FBSOA power MOSFETs include circuit breakers, current sources, programmable loads, power controllers, power regulators, motor control, power amplifiers and soft start applications. In the linear mode, a power MOSFET is subjected to high thermo-electrical stress caused by the simultaneous occurrence of high drain voltage and current resulting in high power dissipation. IXYS has optimized the internal structure of these MOSFETs achieving an extended "forward bias safe operating area" (FBSOA) capability to overcome the limitations posed by conventional power MOSFETs operating in current saturation region. These extended FBSOA Power MOSFETs are not intended for high speed switching applications.

# Power MOSFETs and MOSFET Modules

---

## Depletion-Mode MOSFET

Depletion-Mode Power MOSFETs operate in a ‘normally-on’ mode, not requiring energy or gate voltage for turn on. Unlike the regular enhancement type MOSFETs these Depletion-Mode MOSFETs require a negative gate bias to turn off. Consequently they remain on at or above zero gate bias voltage but otherwise have similar MOSFET characteristics. The “normally-on” operational mode of these devices combined with an enhanced linear operating capability allows for an ideal device selection in current sources, current regulators, solid-state relays, level shifting, active loads, start-up circuits, and active power filters. Since these devices require no energy or gate voltage for turn-on, high energy efficiency can be achieved through device implementation in zero power “normally on” load switch applications. With the high degree of current regulation, these devices can also act as active inductors with high dynamic impedance in power filter applications to limit voltage and current noise and spikes. Furthermore these devices can provide active circuit protection to limit the surge of current during short-circuit or overload conditions.

## PolarP™ P-Channel Power MOSFETs

IXYS’ Polar technology platform employed in our PolarP™ P-Channel MOSFETs utilizes a proprietary cell design that improves overall device efficiency and performance. This technology platform reduces on-state resistance by as much as 30% and gate charge by 40% compared to legacy counterparts. With such low onstate resistances, these devices offer low conduction and switching losses while a low input capacitance. The combination of low  $R_{DS(on)}$  and gate charge allow for improved energy efficiency. These P-Channel MOSFETs are dynamic dV/dt and avalanche rated making them extremely rugged in demanding operating environments and can easily be paralleled due to an on-state resistance with a positive temperature coefficient. They are ideal for ‘high side’ switching where a simple drive circuit referenced to ground can be used, circumventing additional ‘high side’ driver circuitry commonly involved when using an N-Channel MOSFET. This will help designers to reduce component count and improve reliability. Furthermore it allows for the design of a complementary power output stage, with a corresponding IXYS N-Channel MOSFET, for a power half bridge stage with a simple drive circuit.

## TrenchP™ P-Channel Power MOSFETs

This family of P-Channel devices benefit from technological advances derived from IXYS’ robust Trench cell design commonly implemented in their wide portfolio of industry recognized power devices. They feature an ultra low  $R_{DS(on)}$ , minimizing conduction losses, and promoting improved operating and thermal efficiencies. These TrenchP™ P-Channel MOSFETs are suitable for ‘high side’ switching where a simple drive circuit referenced to ground can be employed, circumventing additional ‘high side’ driver circuitry commonly involved when using an N-Channel MOSFET. This enables designers to reduce component count, thereby improving drive circuit simplicity and cost structure. Furthermore it allows for the design of a complementary power output stage, with a corresponding IXYS N-Channel MOSFET, for a power half bridge stage with a simple drive circuit. Common applications that will greatly benefit from these devices include high side switching, high current regulators, DC Choppers, CMOS high power amplifiers, push-pull amplifiers, and power solid state relays.

## Q3-Class HiPerFET™ MOSFETs

Q3-Class HiPerFET™ MOSFETs (Identified by the suffix letter Q3) is the direct result of a revolutionary new chip design, which decreases the MOSFETs total gate charge ( $Q_g$ ) and the Miller capacitance ( $C_{rss}$ ), while maintaining the ruggedness and fast switching intrinsic diode of the company’s current HiPerFET™ product line. The result is a MOSFET with dramatically improved switching efficiencies and thus enabling higher frequency operation and smaller power supplies.









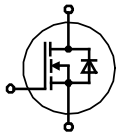

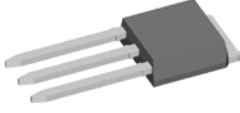
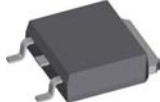
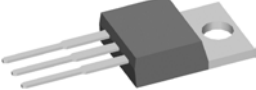
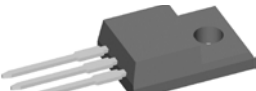
## Very High Voltage Power MOSFETs

IXYS’ VHV N-Channel Power MOSFETs are specifically designed to address demanding, fast-switching applications requiring blocking capabilities of 2.5kV to 4.5kV. These VHV Power MOSFETs are also ideally suited for parallel operation due to the positive temperature coefficient of their on-state resistance. Parallel operation with these devices provides a more cost-effective solution than employing series-connected, lower-voltage MOSFETs. The reduction or replacement of multiple series-connected devices and the associated gate drive circuitry commonly involved, simplifies design, improves reliability, and reduces over-all system cost. These VHV MOSFETs represent an optimal solution in applications such as laser and x-ray generation systems, high-voltage power supplies, pulse circuits, high voltage automated test equipment, and capacitor discharge circuits. 4.5kV device offerings feature high isolation capability with superior thermal performance.





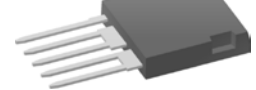

# Trench Power MOSFETs

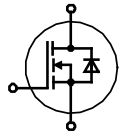

Part Type	V <sub>DSS</sub>	I <sub>D(cont)</sub> <sup>Chip</sup> T <sub>C</sub> = 25°C A	R <sub>DS(on)</sub> T <sub>J</sub> = 25°C Ω	C <sub>iss</sub> typ. ns	Q <sub>g</sub> typ. ns	t <sub>rr</sub> typ. ns	R <sub>thJC</sub> K/W	P <sub>D</sub> W	Fig. No.	Package style
➤ <b>New</b>	V	A	Ω	ns	ns	ns	K/W	W		Outline drawings on pages O-30...O-55
<b>IXTC 110N055T</b>	55	78	0.009	3080	67	70	1.50	100	X010a	X003 <b>TO-251AA</b>
<b>IXTA 110N055T7</b>		110	0.007	3080	67	70	0.65	230	X012b	
<b>IXTF 280N055T</b>		160	0.004	9800	200	40	0.75	200	X024d	
<b>IXTU 12N06T</b>	60	12	0.085	256	3.4	30	4.50	33	X003	
<b>IXTY 12N06T</b>		12	0.085	256	3.4	30	4.50	33	X004	X004 <b>TO-252AA</b>
<b>IXTP 98N075T</b>	75	98	0.01	3100	80	100	0.75	200	X005a	
<b>IXTA 88N085T</b>	85	88	0.011	3140	69	90	0.65	230	X011b	
<b>IXTC 230N085T</b>		120	0.0053	9900	187	90	0.96	160	X010a	X005a <b>TO-220AB</b>
<b>IXTP 60N10TM</b>	100	33	0.019	2650	49	59	2.50	60	X007a	
<b>IXTP 44N10T</b>		44	0.03	1567	27.4	60	1.15	130	X005a	
<b>IXTY 44N10T</b>		44	0.03	1567	27.4	60	1.15	130	X004	
<b>IXTP 60N10T</b>		60	0.018	2650	49	59	0.85	176	X005a	X007a <b>TO-220ABFP</b>
<b>IXTA 60N10T</b>		60	0.018	2650	49	59	0.85	176	X011b	
<b>IXTQ 60N10T</b>		60	0.018	2650	49	59	0.85	176	X017a	
<b>IXTP 80N10T</b>		80	0.014	3040	60	100	0.65	230	X005a	
<b>IXTA 80N10T</b>		80	0.014	3040	60	100	0.65	230	X011b	
<b>IXTA 80N10T7</b>		80	0.014	3040	60	100	0.65	230	X012b	
<b>IXTC 160N10T</b>		83	0.0075	6600	132	60	1.06	140	X010a	
<b>IXTF 200N10T</b>		90	0.007	9400	152	76	0.96	156	X024d	
<b>IXTC 180N10T</b>		90	0.007	6900	151	100	1.00	150	X010a	
<b>IXTL 2x180N10T</b>		100	0.0074	6900	151	60	1.00	150	X022c	
<b>IXTC 200N10T</b>		101	0.0063	9400	152	76	0.96	160	X010a	
<b>IXTP 130N10T</b>		130	0.0091	5080	104	67	0.42	360	X005a	X011b <b>TO-263AB</b>
<b>IXTH 130N10T</b>		130	0.0091	5080	104	67	0.42	360	X014a	
<b>IXTA 130N10T</b>		130	0.0091	5080	104	67	0.42	360	X011b	
<b>IXTA 130N10T7</b>		130	0.0091	5080	104	67	0.42	360	X012b	
<b>IXTQ 130N10T</b>		130	0.0091	5080	104	67	0.42	360	X017a	
<b>IXTP 160N10T</b>		160	0.007	6600	132	60	0.35	430	X005a	
<b>IXTH 160N10T</b>		160	0.007	6600	132	100	0.35	430	X014a	
<b>IXTA 160N10T</b>		160	0.007	6600	132	60	0.35	430	X011b	
<b>IXTA 160N10T7</b>		160	0.007	6600	132	100	0.35	430	X012b	
<b>IXTQ 160N10T</b>		160	0.007	6600	132	100	0.35	430	X017a	
<b>IXTP 180N10T</b>		180	0.0064	6900	151	72	0.31	480	X005a	
<b>IXTH 180N10T</b>		180	0.0064	6900	151	100	0.31	480	X014a	
<b>IXTA 180N10T</b>		180	0.0064	6900	151	72	0.31	480	X011b	
<b>IXTA 180N10T7</b>		180	0.0064	6900	151	100	0.31	480	X012b	
<b>IXTQ 180N10T</b>		180	0.0064	6900	151	100	0.31	480	X017a	
<b>IXTV 200N10T</b>		200	0.0055	9400	152	76	0.27	550	X009a	
<b>IXTN 200N10T</b>		200	0.0055	9400	152	76	0.30	550	X027a	
<b>IXTH 200N10T</b>		200	0.0055	9400	152	76	0.27	550	X014a	
<b>IXTQ 200N10T</b>		200	0.0055	9400	152	76	0.27	550	X017a	
<b>IXTN 320N10T</b>		320	0.0032	22600	375	100	0.22	680	X027a	
<b>IXTP 42N15T</b>	150	42	0.45	1880	21	100	0.75	200	X005a	
<b>IXTA 42N15T</b>		42	0.045	1880	21	100	0.75	200	X011b	
<b>IXTP 56N15T</b>		56	0.036	2250	34	100	0.50	300	X005a	
<b>IXTA 56N15T</b>		56	0.036	2250	34	100	0.50	300	X011b	

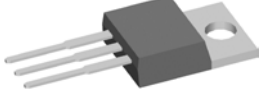
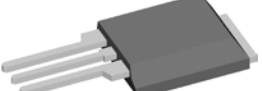
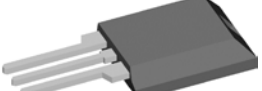

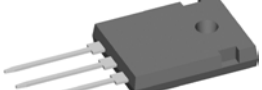
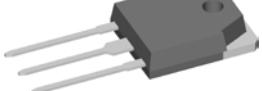



# Trench Power MOSFETs

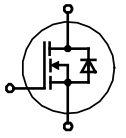

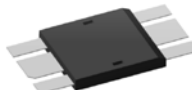
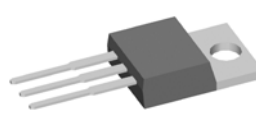

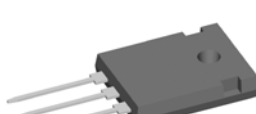
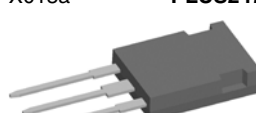
Part Type	V <sub>DSS</sub>	I <sub>D(cont)</sub> Chip T <sub>C</sub> = 25°C	R <sub>DS(on)</sub> T <sub>J</sub> = 25°C	C <sub>iss</sub>	Q <sub>g</sub>	t <sub>rr</sub>	R <sub>thJC</sub>	P <sub>D</sub>	Fig. No.	Package style
➤ New	V	A	Ω	typ. ns	typ. ns	typ. ns	K/W	W		Outline drawings on pages O-30...O-55
IXTP 102N15T	150	102	0.018	5220	87	97	0.33	455	X005a	<b>TO-220AB</b> 
IXTH 102N15T		102	0.018	5220	87	97	0.33	455	X014a	
IXTA 102N15T		102	0.018	5220	87	97	0.33	455	X011b	
IXTQ 102N15T		102	0.018	5220	87	97	0.33	455	X017a	
IXTH 130N15T		130	0.012	9800	113	100	0.20	750	X014a	
IXTQ 130N15T		130	0.012	9800	113	100	0.20	750	X017a	
IXTH 160N15T		160	0.0096	8800	160	115	0.18	830	X014a	
IXTP 32N20T	200	32	0.078	1760	38	110	0.75	200	X005a	<b>PLUS220™</b> 
IXTA 32N20T		32	0.078	1760	38	110	0.75	200	X011b	
IXTP 48N20T		48	0.05	3090	60	130	0.50	250	X005a	
IXTA 48N20T		48	0.05	3090	60	130	0.50	250	X011b	
IXTQ 48N20T		48	0.05	3090	60	130	0.50	250	X017a	
IXTP 60N20T		60	0.04	4530	73	118	0.30	500	X005a	<b>ISOPLUS220™</b> 
IXTA 60N20T		60	0.04	4530	73	118	0.30	500	X011b	
IXTQ 60N20T		60	0.04	4530	73	118	0.30	500	X017a	
IXTP 86N20T		86	0.029	4500	90	140	0.31	480	X005a	
IXTA 86N20T		86	0.029	4500	90	140	0.31	480	X011b	
IXTQ 86N20T		86	0.029	4500	90	140	0.31	480	X017a	
IXTV 102N20T		102	0.023	6800	114	130	0.20	750	X009a	<b>TO-263AB</b> 
IXTH 102N20T	102	0.023	6800	114	130	0.20	750	X014a		
IXTQ 102N20T	102	0.023	6800	114	130	0.20	750	X017a		
IXTH 130N20T	130	0.016	8800	150	150	0.18	830	X014a		
IXTC 96N25T	250	40	0.031	6100	114	158	0.85	147	X010a	
IXTC 110N25T		50	0.027	9400	157	170	0.69	180	X010a	
IXTP 50N25T		50	0.06	4000	78	166	0.31	400	X005a	<b>TO-247AD</b> 
IXTH 50N25T		50	0.06	4000	78	166	0.31	400	X014a	
IXTA 50N25T		50	0.06	4000	78	166	0.31	400	X011b	
IXTQ 50N25T		50	0.06	4000	78	166	0.31	400	X017a	
IXTP 76N25T		76	0.039	4920	92	148	0.27	460	X005a	<b>TO-3P</b> 
IXTH 76N25T		76	0.039	4920	92	148	0.27	460	X014a	
IXTA 76N25T		76	0.039	4920	92	148	0.27	460	X011b	
IXTQ 76N25T		76	0.039	4920	92	148	0.27	460	X017a	
IXTV 86N25T		86	0.037	5330	105	156	0.23	540	X009a	
IXTH 86N25T		86	0.037	5330	105	156	0.23	540	X014a	
IXTQ 86N25T		86	0.037	5330	105	156	0.23	540	X017a	
IXTV 96N25T		96	0.029	6100	114	158	0.20	625	X009a	
IXTH 96N25T	96	0.029	6100	114	158	0.20	625	X014a		
IXTQ 96N25T	96	0.029	6100	114	158	0.20	625	X017a		
IXTH 110N25T		110	0.024	9400	157	170	0.18	694	X014a	

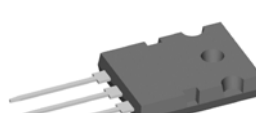
# Trench HiPerFETs with Fast Intrinsic Diode



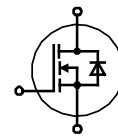

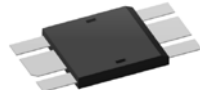
Part Type	V <sub>DSS</sub> V	I <sub>D(cont)</sub> Chip T <sub>C</sub> = 25°C A	R <sub>DS(on)</sub> T <sub>C</sub> = 25°C Ω	C <sub>iss</sub> typ. pF	Q <sub>g</sub> typ. nC	t <sub>rr</sub> max. *typ. ns	R <sub>thjC</sub> K/W	P <sub>D</sub> W	Fig. No.	Package style Outline drawings on pages O-30...O-55		
<b>IXFA 130N10T</b>	100	130	0.0091	5080	104	67	0.42	360	X011b	D5 <b>DE 475</b> 		
<b>IXFP 130N10T</b>		130	0.0091	5080	104	67	0.42	360	X005a			
<b>IXFH 230N10T</b>		230	0.0047	15300	250	*82	0.23	650	X014a			
<b>IXFX 360N10T</b>		360	0.0029	33000	525	130	0.12	1250	X015a			
<b>IXFN 360N10T</b>		360	0.0026	33000	525	130	0.18	830	X027a			
<b>IXFK 360N10T</b>		360	0.0029	33000	525	130	0.12	1250	X020a			
<b>IXFX 420N10T</b>		420	0.0026	47000	670	140	0.09	1670	X015a			
<b>IXFN 420N10T</b>		420	0.0023	47000	670	140	0.14	1070	X027a			
<b>IXFK 420N10T</b>		420	0.0026	47000	670	140	0.09	1670	X020a			
<b>IXFA 102N15T</b>	150	102	0.018	5220	87	120	0.33	455	X011b	X005a <b>TO-220AB</b> 		
<b>IXFH 102N15T</b>		102	0.018	5220	87	120	0.33	455	X014a			
<b>IXFP 102N15T</b>		102	0.018	5220	87	120	0.33	455	X005a			
<b>IXFH 160N15T</b>		160	0.0096	8800	160	90	0.18	830	X014a			
<b>IXFH 150N20T</b>	200	150	0.015	11700	177	*100	0.14	890	X014a	X011b <b>TO-263AB</b> 		
<b>IXFT 150N20T</b>		150	0.015	11700	177	*100	0.14	890	X019			
<b>IXFR 230N20T</b>		156	0.008	28000	378	200	0.25	600	X016a			
<b>IXFX 170N20T</b>		170	0.011	19600	265	200	0.13	1150	X015a			
<b>IXFK 170N20T</b>		170	0.011	19600	265	200	0.13	1150	X020a			
<b>IXFN 230N20T</b>		220	0.0075	28000	378	200	0.138	1090	X027a			
<b>IXFX 230N20T</b>		230	0.0075	28000	378	200	0.09	1670	X015a			
<b>IXFK 230N20T</b>		230	0.0075	28000	378	200	0.09	1670	X020a			
<b>IXFZ 140N25T</b>		250	100	0.017	19000	255	200	0.28	445		DE475	X014a <b>TO-247AD</b> 
<b>IXFV 110N25T</b>	110		0.024	9400	157	170	0.18	694	X009a			
<b>IXFH 110N25T</b>	110		0.024	9400	157	170	0.18	694	X014a			
<b>IXFH 120N25T</b>	120		0.023	11300	180	*108	0.14	890	X014a			
<b>IXFT 120N25T</b>	120		0.023	11300	180	*108	0.14	890	X019			
<b>IXFN 140N25T</b>	120		0.017	19000	255	200	0.18	690	X027a			
<b>IXFX 140N25T</b>	140		0.017	19000	255	200	0.13	960	X015a			
<b>IXFK 140N25T</b>	140		0.017	19000	255	200	0.13	960	X020a			
<b>IXFN 180N25T</b>	164		0.0129	28000	345	200	0.138	900	X027a			
<b>IXFX 180N25T</b>	180		0.0129	28000	345	200	0.09	1390	X015a			
<b>IXFK 180N25T</b>	180		0.0129	28000	345	200	0.09	1390	X020a			
<b>IXFH 86N30T</b>	300		86	0.043	11300	180	150	0.15	830	X014a	X015a <b>PLUS247</b> 	
<b>IXFT 86N30T</b>			86	0.043	11300	180	150	0.15	830	X019		
<b>IXFH 94N30T</b>			94	0.036	11400	190	*155	0.14	890	X014a		
<b>IXFT 94N30T</b>			94	0.036	11400	190	*155	0.14	890	X019		
<b>IXFX 120N30T</b>		120	0.024	20000	265	200	0.13	960	X015a			
<b>IXFK 120N30T</b>		120	0.024	20000	265	200	0.13	960	X020a			
<b>IXFN 160N30T</b>		130	0.019	28000	335	200	0.138	900	X027a			
<b>IXFX 160N30T</b>		160	0.019	28000	335	200	0.09	1390	X015a			
<b>IXFK 160N30T</b>		160	0.019	28000	335	200	0.09	1390	X020a			
										X019 <b>TO-268AA</b> 		
										X020a <b>TO-264</b> 		
										X027a <b>SOT-227B miniBLOC</b> 		

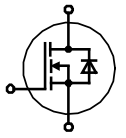

Part Type	V <sub>DSS</sub>	I <sub>D(cont)</sub> Chip T <sub>C</sub> = 25°C	R <sub>DS(on)</sub> T <sub>C</sub> = 25°C	C <sub>iss</sub> typ.	Q <sub>g</sub> typ.	t <sub>rr</sub> typ.	R <sub>thJC</sub>	P <sub>D</sub>	Fig. No.	Package style Outline drawings on pages O-30...O-55
w	V	A	Ω	pF	nC	ns	K/W	W		
<b>IXTP 100N04T2</b>	40	100	0.007	2690	25.5	34	1.00	150	X005a	D5 <b>DE 475</b>
<b>IXTA 100N04T2</b>		100	0.007	2690	25.5	34	1.00	150	X011b	
<b>IXTP 120N04T2</b>		120	0.0061	3240	58	35	0.75	200	X005a	X004 <b>TO-252AA</b>
<b>IXTA 120N04T2</b>		120	0.0061	3240	58	35	0.75	200	X011b	
<b>IXTP 160N04T2</b>		160	0.005	4640	79	40	0.60	250	X005a	X005a <b>TO-220AB</b>
<b>IXTA 160N04T2</b>		160	0.005	4640	79	40	0.60	250	X011b	
<b>IXTP 220N04T2</b>		220	0.0035	6820	112	45	0.42	360	X005a	X009a <b>PLUS220</b>
<b>IXTA 220N04T2</b>		220	0.0035	6820	112	45	0.42	360	X011b	
<b>IXTA 220N04T2-7</b>		220	0.0035	6820	112	45	0.42	360	X012b	X011b <b>TO-263AB</b>
<b>IXTP 300N04T2</b>		300	0.0025	10700	145	53	0.31	480	X005a	
<b>IXTH 300N04T2</b>		300	0.0025	10700	145	53	0.31	480	X014a	X015a
<b>IXTA 300N04T2</b>		300	0.0025	10700	145	53	0.31	480	X011b	
<b>IXTA 300N04T2-7</b>		300	0.0025	10700	145	53	0.31	480	X012b	X027a
<b>IXTH 420N04T2</b>		420	0.002	19700	315	74	0.16	935	X014a	
<b>IXTH 500N04T2</b>		500	0.0016	25000	405	84	0.15	1000	X014a	X020a <b>TO-264</b>
<b>IXTT 500N04T2</b>		500	0.0016	25000	405	84	0.15	1000	X019	
<b>IXTX 600N04T2</b>		600	0.0015	40000	590	100	0.12	1250	X015a	X027a <b>SOT-227B miniBLOC</b>
<b>IXTN 600N04T2</b>		600	0.00105	40000	590	100	0.16	940	X027a	
<b>IXTK 600N04T2</b>		600	0.0015	40000	590	100	0.12	1250	X020a	
<b>IXTA 90N055T2</b>		55	90	0.0084	2770	42	37	1.00	150	X011b
<b>IXTP 90N055T2</b>	90		0.0084	2770	42	37	1.00	150	X005a	X014a <b>TO-247AD</b>
<b>IXTY 90N055T2</b>	90		0.0084	2770	42	37	1.00	150	X004	
<b>IXTP 110N055T2</b>	110		0.0066	3060	57	38	0.82	180	X005a	X019 <b>TO-268AA</b>
<b>IXTA 110N055T2</b>	110		0.0066	3060	57	38	0.82	180	X011b	
<b>IXTP 140N055T2</b>	140		0.0054	4760	82	40	0.60	250	X005a	X019 <b>TO-268AA</b>
<b>IXTA 140N055T2</b>	140		0.0054	4760	82	40	0.60	250	X011b	
<b>IXTP 200N055T2</b>	200		0.0042	6970	109	49	0.42	360	X005a	X019 <b>TO-268AA</b>
<b>IXTA 200N055T2</b>	200		0.0042	6970	109	49	0.42	360	X011b	
<b>IXTA 200N055T2-7</b>	200		0.0042	6970	109	49	0.42	360	X012b	X019 <b>TO-268AA</b>
<b>IXTP 260N055T2</b>	260		0.0033	10800	140	60	0.31	480	X005a	
<b>IXTH 260N055T2</b>	260		0.0033	10800	140	60	0.31	480	X014a	X019 <b>TO-268AA</b>
<b>IXTA 260N055T2</b>	260		0.0033	10800	140	60	0.31	480	X011b	
<b>IXTA 260N055T2-7</b>	260		0.0033	10800	140	60	0.31	480	X012b	X019 <b>TO-268AA</b>
<b>IXTV 270N055T2</b>	270		0.003	9700	167	63	0.24	625	X009a	
<b>IXTH 360N055T2</b>	360		0.0024	20000	330	78	0.16	935	X014a	X019 <b>TO-268AA</b>
<b>IXTT 360N055T2</b>	360		0.0024	20000	330	78	0.16	935	X019	
<b>IXTH 440N055T2</b>	440		0.0018	25000	405	76	0.15	1000	X014a	X019 <b>TO-268AA</b>
<b>IXTT 440N055T2</b>	440		0.0018	25000	405	76	0.15	1000	X019	
<b>IXTX 550N055T2</b>	550		0.0016	40000	595	100	0.12	1250	X015a	X027a <b>SOT-227B miniBLOC</b>
<b>IXTN550N055T2</b>	550	0.0013	40000	595	100	0.16	940	X027a	X020a <b>TO-264</b>	
<b>IXTK 550N055T2</b>	550	0.0016	40000	595	100	0.12	1250	X020a		X019 <b>TO-268AA</b>
<b>IXTZ 550N055T2</b>		550	0.001	40000	595	100	0.25	600	D5	
<b>IXTP 130N065T2</b>	65	130	0.0066	4800	79	41	0.60	250	X005a	X011b
<b>IXTA 130N065T2</b>		130	0.0066	4800	79	41	0.60	250	X011b	

# TrenchT2™ Power MOSFETs

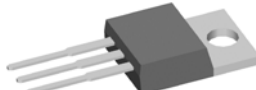

Part Type	V <sub>DSS</sub> V	I <sub>D(cont)</sub> Chip T <sub>C</sub> = 25°C A	R <sub>DS(on)</sub> T <sub>C</sub> = 25°C Ω	C <sub>iss</sub> typ. pF	Q <sub>g</sub> typ. nC	t <sub>rr</sub> typ. ns	R <sub>thJC</sub> K/W	P <sub>D</sub> W	Fig. No.	Package style Outline drawings on pages O-30...O-55
IXTP 70N075T2	75	70	0.012	2580	46	48	1.00	150	X005a	X005a <b>TO-220AB</b> 
IXTA 70N075T2		70	0.012	2580	46	48	1.00	150	X011b	
IXTP 90N075T2		90	0.01	3290	54	50	0.82	180	X005a	X011b <b>TO-263AB</b> 
IXTA 90N075T2		90	0.01	3290	54	50	0.82	180	X011b	
IXTP 120N075T2		120	0.0077	4740	78	50	0.60	250	X005a	X012b <b>TO-263AB</b> 
IXTA 120N075T2		120	0.0077	4740	78	50	0.60	250	X011b	
IXTP 170N075T2		170	0.0054	6860	109	63	0.42	360	X005a	X012b
IXTA 170N075T2		170	0.0054	6860	109	63	0.42	360	X011b	
IXTP 230N075T2		230	0.0042	10.5	178	66	0.31	480	X005a	X012b
IXTA 230N075T2		230	0.0042	10.5	178	66	0.31	480	X011b	
IXTA 230N075T2-7		230	0.0042	10500	178	66	0.31	480	X012b	
IXTP 80N12T2	120	80	0.017	4740	80	90	0.46	325	X005a	X011b
IXTA 80N12T2		80	0.017	4740	80	90	0.46	325	X011b	





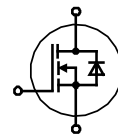

## TrenchT2 Power MOSFETs (SMPD Package)

Part Type	V <sub>DSS</sub> V	I <sub>D(cont)</sub> Chip T <sub>C</sub> = 25°C A	R <sub>DS(on)</sub> T <sub>C</sub> = 25°C Ω	C <sub>iss</sub> typ. pF	Q <sub>g</sub> typ. nC	t <sub>rr</sub> typ. ns	R <sub>thJC</sub> K/W	P <sub>D</sub> W	Fig. No.	Package style Outline drawings on pages O-30...O-55
➤ New										
➤ MMIX 1T600N04T2	40	600	0.0013	40000	590	100	0.18	830	X031a	X031a <b>SMPD-X</b> 
➤ MMIX 1T550N055T2	55	550	0.0013	40000	595	100	0.18	830	X031a	

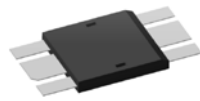
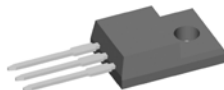

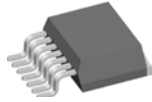
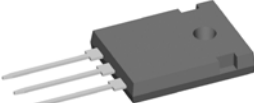
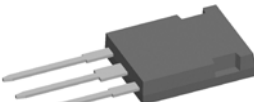

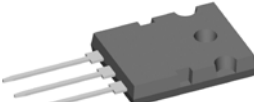
## TrenchT2 HiPerFETs (SMPD Package)

Part Type	V <sub>DSS</sub> V	I <sub>D(cont)</sub> Chip T <sub>C</sub> = 25°C A	R <sub>DS(on)</sub> T <sub>C</sub> = 25°C Ω	C <sub>iss</sub> typ. pF	Q <sub>g</sub> typ. nC	t <sub>rr</sub> typ. ns	R <sub>thJC</sub> K/W	P <sub>D</sub> W	Fig. No.
➤ New									
➤ MMIX 1F520N075T2	75	500	0.0016	41000	545	150	0.18	830	X031a

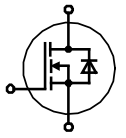

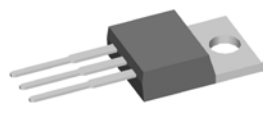
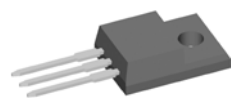

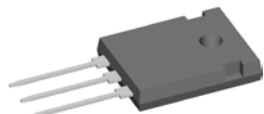
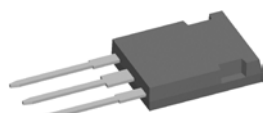
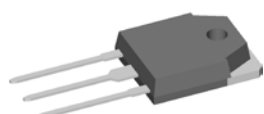

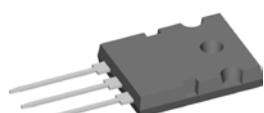

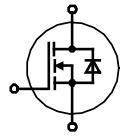

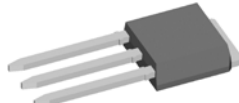
Part Type	V <sub>DSS</sub>	I <sub>D(cont)</sub> Chip T <sub>C</sub> = 25°C	R <sub>DS(on)</sub> T <sub>J</sub> = 25°C	C <sub>iss</sub> typ.	Q <sub>g</sub> typ.	t <sub>rr</sub> typ.	R <sub>thJC</sub>	P <sub>D</sub>	Fig. No.	Package style Outline drawings on pages O-30...O-55
➤ New	V	A	Ω	pF	nC	ns	K/W	W		
<b>IXFP 230N075T2</b>	75	230	0.0042	10500	178	59	0.31	480	X007a	D5 <b>DE 475</b>
<b>IXFH 230N075T2</b>		230	0.0042	10500	178	59	0.31	480	X014a	
<b>IXFA 230N075T2</b>		230	0.0042	10500	178	59	0.31	480	X011b	
<b>IXFA 230N075T2-7</b>		230	0.0042	10500	178	59	0.31	480	X012b	<b>TO-220FPAB</b>
<b>IXFH 340N075T2</b>		340	0.0032	19000	300	75	0.16	935	X014a	
<b>IXFT 340N075T2</b>		340	0.0032	19000	300	75	0.16	935	X019	
<b>IXFH 400N075T2</b>		400	0.0023	24000	420	77	0.15	1000	X014a	
<b>IXFT 400N075T2</b>		400	0.0023	24000	420	77	0.15	1000	X019	<b>TO-263AB</b>
<b>IXFZ 520N075T2</b>		465	0.0013	41000	545	na	0.25	600	D5	
<b>IXFN 520N075T2</b>		480	0.0019	41000	545	na	0.16	940	X027a	
<b>IXFX 520N075T2</b>		520	0.0022	41000	545	na	0.12	1250	X015a	
<b>IXFK 520N075T2</b>		520	0.0022	41000	545	na	0.12	1250	X020a	
<b>IXFP 130N10T2</b>	100	130	0.0091	6600	130	na	0.42	360	X007a	<b>TO-263AB</b>
<b>IXFA 130N10T2</b>		130	0.0091	6600	130	na	0.42	360	X011b	
<b>IXFP 180N10T2</b>		180	0.006	10500	185	66	0.31	480	X007a	
<b>IXFA 180N10T2</b>		180	0.006	10500	185	66	0.31	480	X011b	
<b>IXFH 320N10T2</b>		320	0.0035	25000	430	98	0.15	1000	X014a	<b>TO-247AD</b>
<b>IXFT 320N10T2</b>		320	0.0035	26000	430	98	0.15	1000	X019	
<b>IXFP 76N15T2</b>	150	76	0.02	5800	97	69	0.43	350	X007a	
<b>IXFA 76N15T2</b>		76	0.02	5800	97	69	0.43	350	X011b	
<b>IXFP 110N15T2</b>		110	0.013	8600	150	85	0.31	480	X007a	<b>PLUS247</b>
<b>IXFH 110N15T2</b>		110	0.013	8600	150	85	0.31	480	X014a	
<b>IXFA 110N15T2</b>		110	0.013	8600	150	85	0.31	480	X011b	
<b>IXFH 160N15T2</b>		160	0.009	15000	253	na	0.17	880	X014a	
<b>IXFX 240N15T2</b>		240	0.0052	32000	460	na	0.12	1250	X015a	<b>TO-268AA</b>
<b>IXFN 240N15T2</b>		240	0.0052	32000	460	na	0.18	830	X027a	
<b>IXFK 240N15T2</b>		240	0.0052	32000	460	na	0.12	1250	X020a	
<b>IXFN 360N15T2</b>		310	0.004	47500	715	na	0.14	1070	X027a	
<b>IXFX 360N15T2</b>		360	0.004	47500	715	na	0.09	1670	X015a	<b>TO-264</b>
<b>IXFK 360N15T2</b>		360	0.004	47500	715	na	0.09	1670	X020a	
<b>IXFX 220N17T2</b>	170	220	0.0063	31000	500	na	0.12	1250	X015a	
<b>IXFK 220N17T2</b>		220	0.0063	31000	500	na	0.12	1250	X020a	
<b>IXFN 320N17T2</b>		260	0.0052	45000	640	na	0.14	1070	X027a	<b>SOT-227B miniBLOC</b>
<b>IXFX 320N17T2</b>		320	0.0052	45000	640	na	0.09	1670	X015a	
<b>IXFK 320N17T2</b>		320	0.0052	45000	640	na	0.09	1670	X020a	
<b>IXFH 150N17T2</b>	175	150	0.012	14600	233	na	0.17	880	X014a	
<b>IXFT 150N17T2</b>		150	0.012	14600	233	na	0.17	880	X019	

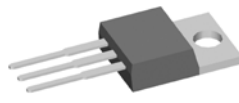
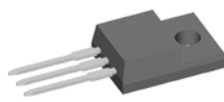
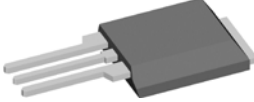
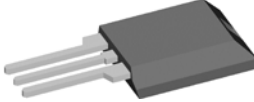

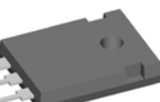
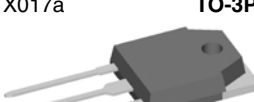

Part Type	V <sub>DSS</sub>	I <sub>D(cont)</sub> Chip T <sub>C</sub> = 25°C	R <sub>DS(on)</sub> T <sub>J</sub> = 25°C	C <sub>iss</sub> typ	Q <sub>g</sub> typ	t <sub>r</sub> typ	R <sub>th(jc)</sub>	P <sub>D</sub>	Fig. No.	Package style Outline drawings on pages O-30...O-55
➤ New	V	A	Ω	pF	nC	ns	K/W	W		
IXTP 75N10P	100	75	0.025	2250	74	120	0.42	360	X005a	X005a <b>TO-220AB</b> 
IXTA 75N10P		75	0.025	2250	74	120	0.42	360	X011b	
IXTQ 75N10P		75	0.025	2250	74	120	0.42	360	X017a	
IXTT 110N10P		110	0.015	3550	110	130	0.31	480	X019	
IXTQ 110N10P		110	0.015	3550	110	130	0.31	480	X017a	
<b>IXTR 200N10P</b>		<b>120</b>	<b>0.008</b>	<b>7600</b>	<b>235</b>	<b>100</b>	<b>0.50</b>	<b>300</b>	<b>X016a</b>	
IXTT 140N10P		140	0.011	4700	155	120	0.25	600	X019	X007a <b>TO-220FPAB</b> 
IXTQ 140N10P		140	0.011	4700	155	120	0.25	600	X017a	
IXTK 170N10P		170	0.009	6000	198	120	0.21	715	X020a	
IXTT 170N10P		170	0.009	6000	198	120	0.21	715	X019	
IXTQ 170N10P		170	0.009	6000	198	120	0.21	715	X017a	
IXTK 200N10P		200	0.0075	7600	240	100	0.18	800	X020a	
IXTP 62N15P	150	62	0.04	2250	70	150	0.42	350	X005a	X011b <b>TO-263AB</b> 
IXTA 62N15P		62	0.04	2250	70	150	0.42	350	X011b	
IXTQ 62N15P		62	0.04	2250	70	150	0.42	350	X017a	
IXTT 96N15P		96	0.024	3500	110	150	0.31	480	X019	
IXTQ 96N15P		96	0.024	3500	110	150	0.31	480	X017a	
IXTT 120N15P		120	0.016	4900	150	150	0.25	600	X019	X014a <b>TO-247AD</b> 
IXTQ120N15P		120	0.016	4900	150	150	0.25	600	X017a	
IXTK150N15P		150	0.013	5800	190	150	0.21	714	X020a	
IXTQ150N15P		150	0.013	5800	190	150	0.21	714	X017a	
IXTK 180N15P		180	0.01	7000	240	150	0.18	800	X020a	
IXTP 50N20PM	200	20	0.06	2720	70	150	1.66	90	X007a	X016a <b>ISOPLUS247™</b> 
IXTP 50N20P		50	0.06	2720	70	150	0.42	360	X005a	
IXTA 50N20P		50	0.06	2720	70	150	0.42	360	X011b	
IXTQ 50N20P		50	0.06	2720	70	150	0.42	360	X017a	
IXTT 74N20P		74	0.034	3300	107	160	0.31	480	X019	
IXTQ 74N20P		74	0.034	3300	107	160	0.31	480	X017a	X014a <b>TO-3P</b> 
IXTH 96N20P		96	0.024	4800	145	160	0.25	600	X014a	
IXTT 96N20P		96	0.024	4800	145	160	0.25	600	X019	
IXTQ 96N20P		96	0.024	4800	145	160	0.25	600	X017a	
IXTK 120N20P		120	0.022	6000	152	180	0.21	714	X020a	
IXTQ 120N20P		120	0.022	6000	152	180	0.21	714	X017a	X017a <b>TO-268AA</b> 
IXTK 140N20P		140	0.018	7500	240	180	0.18	800	X020a	
IXTP 42N25P		250	42	0.084	2300	70	200	0.42	300	
IXTA 42N25P	42		0.084	2300	70	200	0.42	300	X011b	
IXTQ 42N25P	42		0.084	2300	70	200	0.42	300	X017a	
IXTT 64N25P	64		0.049	3450	105	200	0.31	400	X019	
IXTQ 64N25P	64		0.049	3450	105	200	0.31	400	X017a	
IXTK 82N25P		82	0.035	4800	142	200	0.25	500	X020a	X020a <b>TO-264</b> 
IXTT 82N25P		82	0.035	4800	142	200	0.25	500	X019	
IXTQ 82N25P		82	0.035	4800	142	200	0.25	500	X017a	
IXTK 100N25P		100	0.027	6300	185	200	0.21	600	X020a	
IXTT 100N25P		100	0.027	6300	185	200	0.21	600	X019	
IXTQ 100N25P		100	0.027	6300	185	200	0.21	600	X017a	X020a
IXTK 120N25P		120	0.024	8700	185	200	0.18	700	X020a	



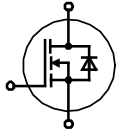

Part Type	V <sub>DSS</sub> V	I <sub>D(cont)</sub> Chip T <sub>C</sub> = 25°C A	R <sub>DS(on)</sub> T <sub>J</sub> = 25°C Ω	C <sub>iss</sub> typ pF	Q <sub>g</sub> typ nC	t <sub>rr</sub> typ ns	R <sub>thJC</sub> K/W	P <sub>D</sub> W	Fig. No.	Package style Outline drawings on pages O-30...O-55	
<b>IXTQ 69N30PM</b>	300	25	0.049	4960	156	250	1.38	90	X017c	X003 <b>TO-251AA</b> 	
<b>IXTP 36N30P</b>		36	0.11	2250	70	250	0.42	300	X005a		
<b>IXTA 36N30P</b>		36	0.11	2250	70	250	0.42	300	X011b		
<b>IXTQ 36N30P</b>		36	0.11	2250	70	250	0.42	300	X017a		
<b>IXTT 52N30P</b>		52	0.066	3490	110	250	0.31	400	X019		X004 <b>TO-252AA</b> 
<b>IXTQ 52N30P</b>		52	0.066	3490	110	250	0.31	400	X017a		
<b>IXTT 69N30P</b>		69	0.049	4960	156	330	0.25	500	X019		
<b>IXTQ 69N30P</b>		69	0.049	4960	156	330	0.25	500	X017a		
<b>IXTH 88N30P</b>		88	0.04	6300	180	250	0.21	600	X014a		X005a <b>TO-220AB</b> 
<b>IXTK 88N30P</b>		88	0.04	6300	180	250	0.21	600	X020a		
<b>IXTT 88N30P</b>		88	0.04	6300	180	250	0.21	600	X019		
<b>IXTQ 88N30P</b>		88	0.04	6300	180	250	0.21	600	X017a		
<b>IXTK 102N30P</b>		102	0.033	7500	224	250	0.18	700	X020a		X007a <b>TO-220FPAB</b> 
<b>IXTK 140N30P</b>		140	0.24	14800	185	250	0.12	1040	X020a		
<b>IXTP 1R6N50P</b>	500	1.6	6.5	140	3.9	400	2.90	43	X005a	X009a <b>PLUS220</b> 	
<b>IXTY 1R6N50P</b>		1.6	6.5	140	3.9	400	2.90	43	X004		
<b>IXTP 2R4N50P</b>		2.4	3.75	240	6.1	400	2.25	55	X005a		
<b>IXTY 2R4N50P</b>		2.4	3.75	240	6.1	400	2.25	55	X004		
<b>IXTA 3N50P</b>		3.6	2	409	9.3	400	1.80	70	X011b		X010a <b>ISOPLUS220™</b> 
<b>IXTP 3N50P</b>		3.6	2	409	9.3	400	1.80	70	X005a		
<b>IXTY 3N50P</b>		3.6	2	409	9.3	400	1.80	70	X004		
<b>IXTP 8N50PM</b>		4	0.88	1050	20	400	3.00	41	X007a		X011b <b>TO-263AB</b> 
<b>IXTA 5N50P</b>		5	1.4	620	12.6	400	1.40	89	X011b		
<b>IXTP 5N50P</b>		5	1.4	620	12.6	400	1.40	89	X005a		
<b>IXTU 5N50P</b>		5	1.4	620	12.6	400	1.40	89	X003		X014a <b>TO-247AD</b> 
<b>IXTY 5N50P</b>		5	1.4	620	12.6	400	1.40	89	X004		
<b>IXTA 6N50P</b>		6	1.1	740	14.6	400	1.25	100	X011b		X007a <b>TO-3P</b> 
<b>IXTP 6N50P</b>		6	1.1	740	14.6	400	1.25	100	X005a		
<b>IXTP 12N50PM</b>		6	0.5	1830	29	400	2.50	50	X007a		X017a <b>TO-3PFP</b> 
<b>IXTP 16N50PM</b>		7.5	0.42	2480	43	400	1.66	75	X007a		
<b>IXTP 8N50P</b>		8	0.8	1050	20	400	0.83	150	X005a		X017c <b>TO-268AA</b> 
<b>IXTP 22N50PM</b>		8	0.27	2880	50	400	2.90	43	X007a		
<b>IXTA 8N50P</b>		8	0.8	1050	20	400	0.83	150	X011b		X020a <b>TO-264</b> 
<b>IXTP 12N50P</b>		12	0.5	1830	29	300	0.62	200	X005a		
<b>IXTA 12N50P</b>		12	0.5	1830	29	300	0.62	200	X011b		
<b>IXTC 26N50P</b>			15	0.26	3600	65	400	0.95	130		X010a
<b>IXTP 16N50P</b>			16	0.4	2480	43	400	0.42	300		X005a
<b>IXTA 16N50P</b>			16	0.4	2480	43	400	0.42	300		X011b
<b>IXTQ 16N50P</b>			16	0.4	2480	43	400	0.42	300		X017a
<b>IXTV 22N50P</b>			22	0.27	2880	50	400	0.35	350		X009a
<b>IXTH 22N50P</b>			22	0.27	2880	50	400	0.35	350		X014a
<b>IXTQ 22N50P</b>			22	0.27	2880	50	400	0.35	350		X017a
<b>IXTV 26N50P</b>			26	0.23	3600	65	300	0.31	400		X009a
<b>IXTT 26N50P</b>			26	0.23	3600	65	300	0.31	400		X019
<b>IXTQ 26N50P</b>			26	0.23	3600	65	300	0.31	400		X017a
<b>IXTV 30N50P</b>			30	0.2	4150	70	400	0.27	460		X009a

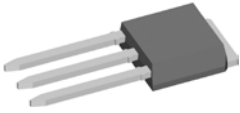
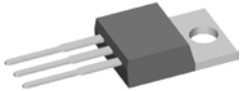



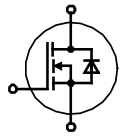

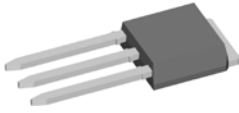
Part Type	V <sub>DSS</sub> V	I <sub>D(cont)</sub> Chip T <sub>C</sub> = 25°C A	R <sub>DS(on)</sub> T <sub>J</sub> = 25°C Ω	C <sub>iss</sub> typ pF	Q <sub>g</sub> typ nC	t <sub>rr</sub> typ ns	R <sub>thJC</sub> K/W	P <sub>D</sub> W	Fig. No.	Package style Outline drawings on pages O-30...O-55
IXTH 30N50P	500	30	0.2	4150	70	400	0.27	460	X014a	X003 <b>TO-251AA</b> 
IXTT 30N50P		30	0.2	4150	70	400	0.27	460	X019	
IXTQ 30N50P		30	0.2	4150	70	400	0.27	460	X017a	
IXTV 36N50P		36	0.17	4700	82	400	0.23	540	X009a	
IXTH 36N50P		36	0.17	4700	82	400	0.23	540	X014a	
IXTT 36N50P		36	0.17	4700	82	400	0.23	540	X019	
IXTQ 36N50P		36	0.17	4700	82	400	0.23	540	X017a	
IXTQ 44N50P		44	0.14	5440	98	400	0.19	650	X017a	
IXTP 1R4N60P	600	1.4	9	140	5.2	500	2.50	50	X005a	X005a <b>TO-220AB</b> 
IXTU 1R4N60P		1.4	9	140	5.2	500	2.50	50	X003	
IXTY 1R4N60P		1.4	9	140	5.2	500	2.50	50	X004	
IXTP 2N60P		2	5.1	240	7	400	2.25	55	X005a	
IXTY 2N60P		2	5.1	240	7	400	2.25	55	X004	
IXTA 3N60P		3	2.9	411	9.8	500	1.80	70	X011b	
IXTP 3N60P		3	2.9	411	9.8	500	1.80	70	X005a	
IXTY 3N60P		3	2.9	411	9.8	500	1.80	70	X004	
IXTA 4N60P		4	2	635	13	500	1.41	89	X011b	
IXTY 4N60P		4	2	635	13	500	1.41	89	X004	
IXTU 4N60P		4	2	635	13	500	1.41	89	X003	
IXTP 4N60P		4	2	635	13	500	1.41	89	X005a	
IXTP 7N60PM		4	1.1	1180	20	500	3.00	41	X007a	
IXTA 5N60P		5	1.7	750	14.2	500	1.25	100	X011b	
IXTP 5N60P		5	1.7	750	14.2	500	1.25	100	X005a	
IXTP 10N60PM		5	0.74	1610	32	500	2.50	50	X007a	
IXTP 14N60PM		7	0.55	2500	36	500	1.66	75	X007a	
IXTP 7N60P		7	1.1	1080	20	500	0.83	150	X005a	
IXTA 7N60P		7	1.1	1080	20	500	0.83	150	X011b	
IXTP 18N60PM		9	0.42	2500	50	500	1.39	90	X007a	
IXTP 10N60P		10	0.74	1720	32	500	0.62	200	X005a	
IXTA 10N60P		10	0.74	1720	32	500	0.62	200	X011b	
IXTP 14N60P		14	0.55	2500	36	500	0.42	300	X005a	
IXTA 14N60P		14	0.55	2500	36	500	0.42	300	X011b	
IXTQ 14N60P		14	0.55	2500	36	500	0.42	300	X017a	
IXTV 18N60P		18	0.42	2500	49	500	0.35	360	X009a	
IXTQ18N60P		18	0.42	2500	49	500	0.35	360	X017a	
IXTV 22N60P		22	0.35	3600	62	500	0.31	400	X009a	
IXTQ 22N60P		22	0.35	3600	62	500	0.31	400	X017a	
IXTV 26N60P		26	0.27	4150	72	500	0.27	460	X009a	
IXTH 26N60P		26	0.27	4150	72	500	0.27	460	X014a	
IXTT 26N60P		26	0.27	4150	72	500	0.27	460	X019	
IXTQ 26N60P		26	0.27	4150	72	500	0.27	460	X017a	
IXTV 30N60P		30	0.24	5050	82	500	0.23	540	X009a	
IXTH 30N60P	30	0.24	5050	82	500	0.23	540	X014a		
IXTT 30N60P	30	0.24	5050	82	500	0.23	540	X019		
IXTQ 30N60P	30	0.24	5050	82	500	0.23	540	X017a		
									X019 <b>TO-268AA</b> 	

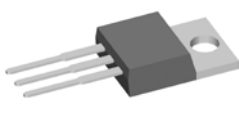

Part Type	V <sub>DSS</sub> V	I <sub>D(cont)</sub> Chip T <sub>C</sub> = 25°C A	R <sub>DS(on)</sub> T <sub>J</sub> = 25°C Ω	C <sub>iss</sub> typ pF	Q <sub>g</sub> typ nC	t <sub>rr</sub> typ ns	R <sub>thJC</sub> K/W	P <sub>D</sub> W	Fig. No.	Package style Outline drawings on pages O-30...O-55
<b>IXTA 1N80P</b>	800	1	14	250	9	700	3.00	42	X011b	<b>TO-251AA</b> 
<b>IXTP 1N80P</b>		1	14	250	9	700	3.00	42	X005a	
<b>IXTU 1N80P</b>		1	14	250	9	700	3.00	42	X003	
<b>IXTY 1N80P</b>		1	14	250	9	700	3.00	42	X004	
<b>IXTA 2N80P</b>		2	6	440	10.6	650	1.80	70	X011b	
<b>IXTP 2N80P</b>		2	6	440	10.6	650	1.80	70	X005a	
<b>IXTU 2N80P</b>		2	6	440	10.6	650	1.80	70	X003	
<b>IXTY 2N80P</b>		2	6	440	10.6	650	1.80	70	X004	
<b>IXTA 4N80P</b>		3.5	3	750	15	600	1.25	100	X011b	
<b>IXTP 4N80P</b>		3.5	3	750	15	600	1.25	100	X005a	
<b>IXTP 05N100P</b>	1000	0.5	30	196	8.1	750	2.50	50	X005a	<b>TO-252AA</b>   <b>TO-220AB</b> 
<b>IXTA 05N100P</b>		0.5	30	196	8.1	750	2.50	50	X011b	
<b>IXTP 08N100P</b>		0.8	20	240	11.3	750	3.00	42	X005a	
<b>IXTY 08N100P</b>		0.8	20	240	11.3	750	3.00	42	X004	
<b>IXTA 08N100P</b>		0.8	20	240	11.3	750	3.00	42	X011b	
<b>IXTP 1N100P</b>		1	15	331	15.5	750	2.50	50	X005a	
<b>IXTY 1N100P</b>		1	15	331	15.5	750	2.50	50	X004	
<b>IXTA 1N100P</b>		1	15	331	15.5	750	2.50	50	X011b	
<b>IXTP 1R4N100P</b>		1.4	11	450	17.8	750	2.00	63	X005a	
<b>IXTY 1R4N100P</b>		1.4	11	450	17.8	750	2.00	63	X004	
<b>IXTA 1R4N100P</b>		1.4	11	666	17.8	750	2.00	63	X011b	
<b>IXTP 2N100P</b>		2	7.5	655	24.3	800	1.45	86	X005a	
<b>IXTY 2N100P</b>		2	7.5	655	24.3	800	1.45	86	X004	
<b>IXTA 2N100P</b>		2	7.5	655	24.3	800	1.45	86	X011b	
<b>IXTP 3N100P</b>		3	4.8	1100	39	820	1.00	125	X005a	
<b>IXTH 3N100P</b>		3	4.8	1100	39	820	1.00	125	X014a	
<b>IXTA 3N100P</b>		3	4.8	1100	39	820	1.00	125	X011b	
<b>IXTP 02N120P</b>		1200	0.2	75	104	4.7	1600	3.80	33	
<b>IXTY 02N120P</b>	0.2		75	104	4.7	1600	3.80	33	X004	
<b>IXTP 06N120P</b>	0.6		34	236	13.3	900	3.00	42	X005a	
<b>IXTA 06N120P</b>	0.6		34	236	13.3	900	3.00	42	X011b	
<b>IXTP 08N120P</b>	0.8		25	333	14	900	2.50	50	X005a	
<b>IXTA 08N120P</b>	0.8		25	333	14	900	2.50	50	X011b	
<b>IXTP 1N120P</b>	1		20	445	17.6	900	2.00	63	X005a	
<b>IXTA 1N120P</b>	1		20	445	17.6	900	2.00	63	X011b	
<b>IXTP 1R4N120P</b>	1.4		13	666	24.8	900	1.45	86	X005a	
<b>IXTA 1R4N120P</b>	1.4		13	725	24.8	900	1.45	86	X011b	
<b>IXTP 2R4N120P</b>	2.4		7.5	1207	37	920	1.00	125	X005a	
<b>IXTH 2R4N120P</b>	2.4		7.5	1207	37	920	1.00	125	X014a	
<b>IXTA 2R4N120P</b>	2.4		7.5	1207	37	920	1.00	125	X011b	

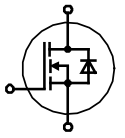
# Polar™ HiPerFETs with Fast Intrinsic Diode

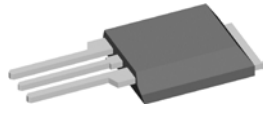
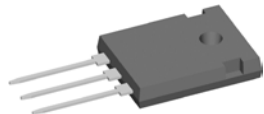

Part Type	V <sub>DSS</sub> V	I <sub>D(cont)</sub> Chip T <sub>C</sub> = 25°C A	R <sub>DS(on)</sub> T <sub>J</sub> = 25°C Ω	C <sub>iss</sub> typ pF	Q <sub>g</sub> typ nC	t <sub>rr</sub> typ ns	R <sub>thJC</sub> K/W	P <sub>D</sub> W	Fig. No.	Package style Outline drawings on pages O-30...O-55
<b>IXFC 110N10P</b>	100	60	0.017	3550	110	150	1.25	120	X010a	 <p><b>PLUS220</b></p> <p>X009a</p> <p>X014a</p> <p>X016a</p> <p>X014a</p> <p>X019</p> <p>X014a</p> <p>X020a</p> <p>X015a</p> <p>X027a</p> <p>X020a</p> <p>X014a</p> <p>X020a</p> <p>X027a</p> <p>X021a</p>
<b>IXFV 110N10P</b>		110	0.015	3550	110	150	0.31	480	X009a	
<b>IXFH 110N10P</b>		110	0.015	3550	110	150	0.31	480	X014a	
<b>IXFR 200N10P</b>		133	0.009	7600	235	150	0.50	300	X016a	
<b>IXFH 140N10P</b>		140	0.011	4700	155	150	0.25	600	X014a	
<b>IXFT 140N10P</b>		140	0.011	4700	155	150	0.25	600	X019	
<b>IXFH 170N10P</b>		170	0.009	6000	198	150	0.21	715	X014a	
<b>IXFK 170N10P</b>		170	0.009	6000	198	150	0.21	715	X020a	
<b>IXFX 200N10P</b>		200	0.0075	7600	235	150	0.18	830	X015a	
<b>IXFN 200N10P</b>		200	0.0075	7600	235	150	0.22	680	X027a	
<b>IXFK 200N10P</b>		200	0.0075	7600	235	150	0.18	830	X020a	
<b>IXFX 250N10P</b>		250	0.0065	16000	205	200	0.12	1250	X015a	
<b>IXFK 250N10P</b>		250	0.0065	16000	205	200	0.12	1250	X020a	
<b>IXFN 300N10P</b>		295	0.0055	23000	279	200	0.14	1070	X027a	
<b>IXFB 300N10P</b>		300	0.0055	23000	279	200	0.10	1500	X021a	
<b>IXFC 96N15P</b>	150	42	0.026	3500	110	200	1.25	120	X010a	 <p><b>TO-247AD</b></p> <p>X015a</p> <p>X014a</p> <p>X016a</p> <p>X014a</p> <p>X019</p> <p>X027a</p> <p>X014a</p> <p>X020a</p> <p>X015a</p> <p>X020a</p> <p>X015a</p> <p>X020a</p> <p>X019</p> <p>X014a</p> <p>X020a</p> <p>X020a</p> <p>X019</p> <p>X0268AA</p> <p>X020a</p> <p>X014a</p> <p>X019</p> <p>X027a</p> <p>X020a</p> <p>X021a</p> <p>X015a</p> <p>X020a</p> <p>X027a</p> <p>X021a</p> <p>X027a</p> <p>X020a</p>
<b>IXFV 96N15P</b>		96	0.024	3500	110	200	0.31	480	X009a	
<b>IXFH 96N15P</b>		96	0.024	3500	110	200	0.31	480	X014a	
<b>IXFR 180N15P</b>		100	0.013	7000	240	200	0.50	300	X016a	
<b>IXFH 120N15P</b>		120	0.016	4900	150	200	0.25	600	X014a	
<b>IXFT 120N15P</b>		120	0.016	4900	150	200	0.25	600	X019	
<b>IXFN 180N15P</b>		150	0.011	7000	240	200	0.22	680	X027a	
<b>IXFH 150N15P</b>		150	0.013	5800	190	200	0.21	714	X014a	
<b>IXFK 150N15P</b>		150	0.013	5800	190	200	0.21	714	X020a	
<b>IXFX 180N15P</b>		180	0.011	7000	240	200	0.18	830	X015a	
<b>IXFK 180N15P</b>		180	0.011	7000	240	200	0.18	830	X020a	
<b>IXFX 220N15P</b>		220	0.009	15400	162	200	0.12	1250	X015a	
<b>IXFK 220N15P</b>		220	0.009	15400	162	200	0.12	1250	X020a	
<b>IXFC 74N20P</b>	200	35	0.036	3300	107	200	1.25	120	X010a	
<b>IXFV 74N20P</b>		74	0.034	3300	107	200	0.31	480	X009a	
<b>IXFH 74N20P</b>		74	0.034	3300	107	200	0.31	480	X014a	
<b>IXFR 140N20P</b>		90	0.022	7500	240	200	0.50	300	X016a	
<b>IXFV 96N20P</b>		96	0.024	4800	145	200	0.25	600	X009a	
<b>IXFH 96N20P</b>		96	0.024	4800	145	200	0.25	600	X014a	
<b>IXFT 96N20P</b>		96	0.024	4800	145	200	0.25	600	X019	
<b>IXFN 140N20P</b>		115	0.018	7500	240	200	0.22	680	X027a	
<b>IXFH 120N20P</b>		120	0.022	6000	152	200	0.21	714	X014a	
<b>IXFK 120N20P</b>		120	0.022	6000	152	200	0.21	714	X020a	
<b>IXFK 140N20P</b>		140	0.018	7500	240	200	0.18	830	X020a	
<b>IXFX 170N20P</b>		170	0.014	11400	185	200	0.12	1250	X015a	
<b>IXFK 170N20P</b>		170	0.014	11400	185	200	0.12	1250	X020a	
<b>IXFN 210N20P</b>		188	0.0105	18600	255	200	0.14	1070	X027a	
<b>IXFB 210N20P</b>		210	0.0105	18600	255	200	0.10	1500	X021a	
<b>IXFH 100N25P</b>	250	100	0.027	6300	185	200	0.21	600	X014a	 <p><b>TO-264</b></p> <p>X020a</p> <p>X021a</p> <p><b>PLUS264</b></p> <p><b>SOT-227B miniBLOC</b></p>
<b>IXFX 120N25P</b>		120	0.024	8700	185	200	0.18	700	X015a	
<b>IXFK 120N25P</b>		120	0.024	8700	185	200	0.18	700	X020a	
<b>IXFC 52N30P</b>	300	24	0.075	3490	110	200	1.25	100	X010a	 <p><b>TO-264</b></p> <p>X020a</p> <p>X021a</p> <p><b>PLUS264</b></p>
<b>IXFV 52N30P</b>		52	0.066	3490	110	200	0.31	400	X009a	
<b>IXFH 52N30P</b>		52	0.066	3490	110	200	0.31	400	X014a	
<b>IXFR 102N30P</b>		60	0.036	7500	224	200	0.50	250	X016a	
<b>IXFH 69N30P</b>		69	0.049	4960	156	200	0.25	500	X014a	
<b>IXFT 69N30P</b>		69	0.049	4960	156	200	0.25	500	X019	

# Polar™ HiPerFETs with Fast Intrinsic Diode

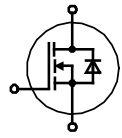

Part Type	V <sub>DSS</sub> V	I <sub>D(cont)</sub> Chip T <sub>C</sub> = 25°C A	R <sub>DS(on)</sub> T <sub>J</sub> = 25°C Ω	C <sub>iss</sub> typ pF	Q <sub>g</sub> typ nC	t <sub>rr</sub> typ ns	R <sub>thJC</sub> K/W	P <sub>D</sub> W	Fig. No.	Package style Outline drawings on pages O-30...O-55
<b>IXFR 140N30P</b>	300	70	0.026	14800	185	200	0.35	360	X016a	X005a <b>TO-220AB</b>
<b>IXFN 102N30P</b>		86	0.033	7500	224	200	0.22	570	X027a	X007a <b>TO-220FPAB</b>
<b>IXFH 88N30P</b>		88	0.04	6300	180	200	0.21	600	X014a	
<b>IXFK 88N30P</b>		88	0.04	6300	180	200	0.21	600	X020a	
<b>IXFT 88N30P</b>		88	0.04	6300	180	200	0.21	600	X019	
<b>IXFK 102N30P</b>		102	0.033	7500	224	200	0.18	700	X020a	
<b>IXFN 140N30P</b>		110	0.024	14800	185	200	0.18	700	X027a	
<b>IXFN 170N30P</b>		138	0.0018	20000	258	200	0.14	890	X027a	
<b>IXFX 140N30P</b>		140	0.024	14800	185	200	0.12	1040	X015a	
<b>IXFK 140N30P</b>		140	0.024	14800	185	200	0.12	1040	X020a	
<b>IXFB 170N30P</b>		170	0.018	20000	258	200	0.10	1250	X021a	
<b>IXFP 3N50PM</b>	500	2.7	2	409	9.3	200	3.50	36	X007a	X007a <b>TO-220FPAB</b>
<b>IXFP 5N50PM</b>		3.2	1.4	620	12.6	200	3.30	38	X007a	
<b>IXFP 8N50PM</b>		4.4	0.8	1050	20	200	3.00	42	X007a	
<b>IXFP12N50PM</b>		6	0.5	1830	29	300	2.50	50	X007a	
<b>IXFC 16N50P</b>		10	0.45	2480	43	200	1.00	125	X010a	X010a <b>ISOPLUS220™</b>
<b>IXFP 12N50P</b>		12	0.5	1830	29	200	0.62	200	X005a	X005a <b>TO-263AB</b>
<b>IXFA 12N50P</b>		12	0.5	1830	29	200	0.62	200	X011b	
<b>IXFC 26N50P</b>		15	0.26	3600	65	250	0.95	130	X010a	X011b <b>TO-263AB</b>
<b>IXFP 16N50P</b>		16	0.4	2480	43	200	0.42	300	X005a	X005a <b>TO-263AB</b>
<b>IXFH 16N50P</b>		16	0.4	2480	43	200	0.42	300	X014a	
<b>IXFA 16N50P</b>		16	0.4	2480	43	200	0.42	300	X011b	X011b <b>TO-263AB</b>
<b>IXFC 36N50P</b>		19	0.19	5500	93	250	0.75	156	X010a	X010a <b>ISOPLUS220™</b>
<b>IXFR 36N50P</b>		19	0.19	5500	93	200	0.75	156	X016a	
<b>IXFV 22N50P</b>		22	0.27	2880	50	200	0.35	350	X009a	X013 <b>PLUS220SMD</b>
<b>IXFH 22N50P</b>		22	0.27	2880	50	200	0.35	350	X014a	X013 <b>PLUS220SMD</b>
<b>IXFR 44N50P</b>		24	0.15	5440	98	200	0.60	208	X016a	
<b>IXFV 26N50P</b>		26	0.23	3600	60	200	0.31	400	X009a	X009a <b>TO-247AD</b>
<b>IXFH 26N50P</b>		26	0.23	3600	60	200	0.31	400	X014a	
<b>IXFV 30N50P</b>		30	0.2	4150	70	200	0.27	460	X009a	X014a <b>TO-247AD</b>
<b>IXFH 30N50P</b>		30	0.2	4150	70	200	0.27	460	X014a	
<b>IXFT 30N50P</b>		30	0.2	4150	70	200	0.27	460	X019	X019 <b>TO-268AA</b>
<b>IXFV 36N50P</b>		36	0.17	5500	93	200	0.23	540	X009a	
<b>IXFH 36N50P</b>		36	0.17	5500	93	200	0.23	540	X014a	X014a <b>TO-247AD</b>
<b>IXFT 36N50P</b>		36	0.17	5500	93	200	0.23	540	X019	
<b>IXFR 64N50P</b>		37	0.095	9700	150	200	0.42	300	X016a	X015a <b>PLUS247</b>
<b>IXFH 44N50P</b>		44	0.14	5440	98	200	0.19	650	X014a	X014a <b>TO-247AD</b>
<b>IXFK 44N50P</b>		44	0.14	5440	98	200	0.19	650	X020a	
<b>IXFT 44N50P</b>		44	0.14	5440	98	200	0.19	650	X019	X019 <b>TO-268AA</b>
<b>IXFR 80N50P</b>		45	0.072	12700	197	200	0.35	360	X016a	
<b>IXFN 64N50P</b>		50	0.085	9700	150	200	0.20	625	X027a	X016a <b>ISOPLUS247™</b>
<b>IXFX 64N50P</b>		64	0.085	9700	150	200	0.15	830	X015a	X015a <b>PLUS247</b>
<b>IXFK 64N50P</b>		64	0.085	9700	150	200	0.15	830	X020a	
<b>IXFN 80N50P</b>		66	0.065	12700	195	200	0.18	700	X027a	X027a <b>ISOPLUS247™</b>

X027a **SOT-227B miniBLOC**



X021a **PLUS264**

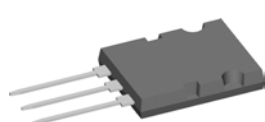

X020a **TO-264**

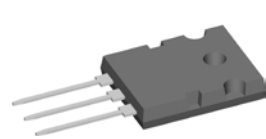

X019 **TO-268AA**

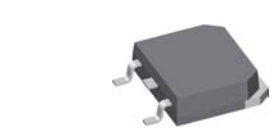

# Polar™ HiPerFETs with Fast Intrinsic Diode

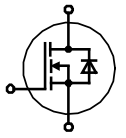

Part Type	V <sub>DSS</sub> V	I <sub>D(cont)</sub> Chip T <sub>C</sub> = 25°C A	R <sub>DS(on)</sub> T <sub>J</sub> = 25°C Ω	C <sub>iss</sub> typ pF	Q <sub>g</sub> typ nC	t <sub>rr</sub> typ ns	R <sub>thJC</sub> K/W	P <sub>D</sub> W	Fig. No.	Package style Outline drawings on pages O-30...O-55	
IXFL 100N50P	500	70	0.052	20000	240	200	0.20	625	X022a	X005a <b>TO-220AB</b>	
IXFX 80N50P		80	0.065	12700	197	200	0.12	1040	X015a		
IXFK 80N50P		80	0.065	12700	197	200	0.12	1040	X020a		
IXFN 100N50P		90	0.049	20000	240	200	0.12	1040	X027a		
IXFB 100N50P		100	0.049	20000	240	200	0.10	1250	X021a		
IXFC 14N60P	600	8	0.63	2500	36	200	1.00	125	X010a		X007a <b>TO-220FPAB</b>
IXFP 10N60P		10	0.74	1720	32	200	0.62	200	X005a		
IXFA 10N60P		10	0.74	1720	32	200	0.62	200	X011b		
IXFC 22N60P		12	0.36	4000	58	200	0.95	130	X010a	X009a <b>PLUS220</b>	
IXFP 14N60P		14	0.55	2500	36	200	0.42	300	X005a		
IXFH 14N60P		14	0.55	2500	36	200	0.42	300	X014a		
IXFA 14N60P		14	0.55	2500	36	200	0.42	300	X011b		
IXFC 30N60P		15	0.25	3820	85	200	0.75	166	X010a		
IXFR 30N60P		15	0.25	3820	85	200	0.75	166	X016a		
IXFV 18N60P		18	0.4	2500	50	200	0.35	360	X009a		
IXFH 18N60P		18	0.4	2500	50	200	0.35	360	X014a	X010a <b>ISOPLUS220™</b>	
IXFR 36N60P		20	0.2	5800	102	200	0.60	208	X016a		
IXFV 22N60P		22	0.35	3600	58	200	0.31	400	X009a		
IXFH 22N60P		22	0.35	3600	58	200	0.31	400	X014a		
IXFV 26N60P		26	0.27	4150	72	200	0.27	460	X009a		
IXFH 26N60P		26	0.27	4150	72	200	0.27	460	X014a		
IXFT 26N60P		26	0.27	4150	72	200	0.27	460	X019	X011b <b>TO-263AB</b>	
IXFV 30N60P		30	0.24	4000	82	200	0.25	500	X009a		
IXFH 30N60P		30	0.24	4000	82	200	0.25	500	X014a		
IXFT 30N60P		30	0.24	4000	82	200	0.25	500	X019		
IXFR 48N60P		32	0.15	8860	150	200	0.42	300	X016a	X013 <b>PLUS220SMD</b>	
IXFR 64N60P		36	0.105	12000	200	200	0.35	360	X016a		
IXFH 36N60P		36	0.19	5800	102	200	0.19	650	X014a		
IXFK 36N60P		36	0.19	5800	102	200	0.19	650	X020a		
IXFT 36N60P		36	0.19	5800	102	200	0.19	650	X019		
IXFN 48N60P		40	0.14	8860	150	200	0.20	625	X027a	X014a <b>TO-247AD</b>	
IXFX 48N60P		48	0.135	8860	150	200	0.15	830	X015a		
IXFK 48N60P		48	0.135	8860	150	200	0.15	830	X020a		
IXFN 64N60P		50	0.096	12000	200	200	0.18	700	X027a		
IXFL 82N60P		54	0.08	23000	240	200	0.20	625	X022a		
IXFX 64N60P		64	0.096	12000	200	200	0.12	1040	X015a	X015a <b>PLUS247</b>	
IXFK 64N60P		64	0.096	12000	200	200	0.12	1040	X020a		
IXFB 82N60P		82	0.075	23000	240	200	0.10	1250	X021a		
IXFN 82N60P		82	0.75	23000	240	200	0.12	1040	X027a		
IXFP 7N80PM	800	3.5	1.44	1890	32	250	2.50	50	X007a		
IXFC 10N80P		5	1.2	2300	40	250	1.25	100	X010a		
IXFC 12N80P		7	0.93	2800	51	250	1.05	120	X010a		
IXFP 7N80P		7	1.44	1800	32	250	0.62	200	X005a	X016a <b>ISOPLUS247™</b>	
IXFA 7N80P		7	1.44	1800	32	250	0.62	200	X011b		

X027a **SOT-227B miniBLOC**



X022a **ISOPLUS264™**

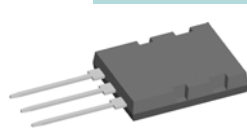

X021a **PLUS264**

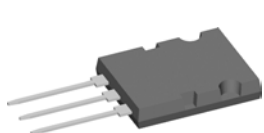

X020a **TO-264**

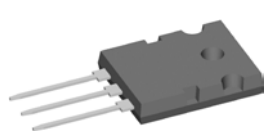



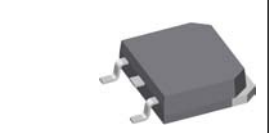

X019 **TO-268AA**

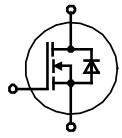

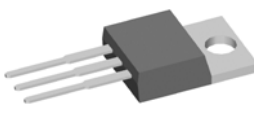
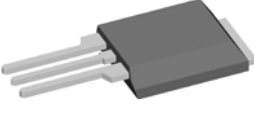
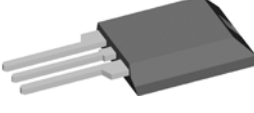
# Polar™ HiPerFETs with Fast Intrinsic Diode

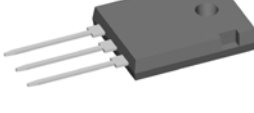
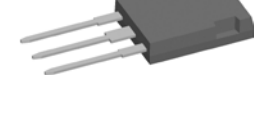
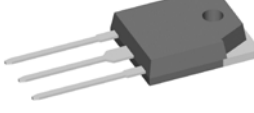

Part Type	V <sub>DSS</sub> V	I <sub>D(cont)</sub> Chip T <sub>C</sub> = 25°C A	R <sub>DS(on)</sub> T <sub>J</sub> = 25°C Ω	C <sub>iss</sub> typ pF	Q <sub>g</sub> typ nC	t <sub>rr</sub> typ ns	R <sub>thJC</sub> K/W	P <sub>D</sub> W	Fig. No.	Package style Outline drawings on pages O-30...O-55	
<b>IXFC 14N80P</b>	800	8	0.77	3900	61	250	0.95	130	X010a	X005a <b>TO-220AB</b> 	
<b>IXFC 16N80P</b>		9	0.65	4000	70	250	0.90	138	X010a		
<b>IXFC 20N80P</b>		10	0.57	4685	86	250	0.80	160	X010a		
<b>IXFR 20N80P</b>		10	0.57	4685	86	250	0.80	160	X016a		
<b>IXFP 10N80P</b>		10	1.1	2050	40	250	0.42	300	X005a	X009a <b>PLUS220</b> 	
<b>IXFH 10N80P</b>		10	1.1	2050	40	250	0.42	300	X014a		
<b>IXFA 10N80P</b>		10	1.1	2050	40	250	0.42	300	X011b		
<b>IXFQ 10N80P</b>		10	1.1	2050	40	250	0.42	300	X017a		
<b>IXFV 12N80P</b>		12	0.85	2800	51	250	0.35	360	X009a		
<b>IXFH 12N80P</b>		12	0.85	2800	51	250	0.35	360	X014a		
<b>IXFQ 12N80P</b>		12	0.85	2800	51	250	0.35	360	X017a		
<b>IXFR 24N80P</b>		13	0.42	7200	105	250	0.60	208	X016a		X010a <b>ISOPLUS220™</b> 
<b>IXFV 14N80P</b>		14	0.72	3900	61	250	0.31	400	X009a		
<b>IXFH 14N80P</b>		14	0.72	3900	61	250	0.31	400	X014a		
<b>IXFT 14N80P</b>		14	0.72	3900	61	250	0.31	400	X019		
<b>IXFQ 14N80P</b>		14	0.72	3900	61	250	0.31	400	X017a		
<b>IXFV 16N80P</b>	16	0.6	4000	70	250	0.27	460	X009a			
<b>IXFH 16N80P</b>	16	0.6	4000	70	250	0.27	460	X014a			
<b>IXFT 16N80P</b>	16	0.6	4000	70	250	0.27	460	X019			
<b>IXFR 32N80P</b>	20	0.29	8800	150	250	0.42	300	X016a	X011b <b>TO-263AB</b> 		
<b>IXFV 20N80P</b>	20	0.52	4685	86	250	0.25	500	X009a			
<b>IXFH 20N80P</b>	20	0.52	4685	86	250	0.25	500	X014a			
<b>IXFT 20N80P</b>	20	0.52	4685	86	250	0.25	500	X019			
<b>IXFH 24N80P</b>	24	0.4	5800	100	250	0.19	650	X014a			
<b>IXFK 24N80P</b>	24	0.4	7200	105	250	0.19	650	X020a			
<b>IXFT 24N80P</b>	24	0.4	5800	100	250	0.19	650	X019			
<b>IXFR 44N80P</b>	26	0.19	12000	200	250	0.35	360	X016a		X014a <b>TO-247AD</b> 	
<b>IXFN 32N80P</b>	29	0.27	8820	150	250	0.20	625	X027a			
<b>IXFX 32N80P</b>	32	0.27	8800	150	250	0.15	830	X015a			
<b>IXFK 32N80P</b>	32	0.27	8800	150	250	0.15	830	X020a			
<b>IXFN 44N80P</b>	36	0.19	12000	200	250	0.12	1200	X027a			
<b>IXFL 60N80P</b>	40	0.15	18000	250	250	0.20	625	X022a			
<b>IXFX 44N80P</b>	44	0.19	12000	198	250	0.12	1200	X015a			
<b>IXFK 44N80P</b>	44	0.19	12000	198	250	0.12	1200	X020a			
<b>IXFN 60N80P</b>	53	0.14	18000	250	250	0.12	1040	X027a			
<b>IXFB 60N80P</b>	60	0.14	18000	250	250	0.10	1250	X021a			
<b>IXFR 18N90P</b>	900	10.5	0.66	5230	97	300	0.62	200	X016a		X017a <b>TO-3P</b> 
<b>IXFV 12N90P</b>		12	0.9	3080	56	300	0.33	380	X009a		
<b>IXFH 12N90P</b>		12	0.9	3080	56	300	0.33	380	X014a		
<b>IXFR 24N90P</b>		13	0.46	7200	130	300	0.54	230	X016a	X017a <b>TO-3P</b> 	
<b>IXFV 18N90P</b>	18	0.6	5230	97	300	0.23	540	X009a			
<b>IXFH 18N90P</b>	18	0.6	5230	97	300	0.23	540	X014a			
<b>IXFT 18N90P</b>	18	0.6	5230	97	300	0.23	540	X019			
<b>IXFR 40N90P</b>		21	0.23	14000	230	300	0.42	300	X016a		
<b>IXFH 24N90P</b>		24	0.42	7200	130	300	0.19	660	X014a		
<b>IXFT 24N90P</b>		24	0.42	7200	130	300	0.19	660	X019	X027a <b>SOT-227B miniBLOC</b> 	
<b>IXFK 32N90P</b>		32	0.3	10600	215	300	0.13	960	X020a		

X019 **TO-268AA**



X020a **TO-264**

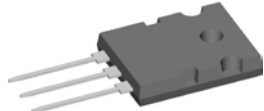

X021a **PLUS264**

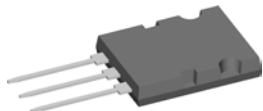

X022a **ISOPLUS264™**

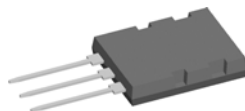

# Polar™ HiPerFETs with Fast Intrinsic Diode

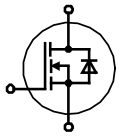

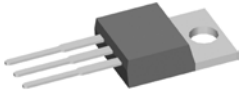
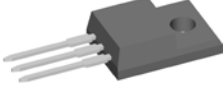
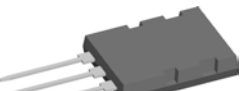
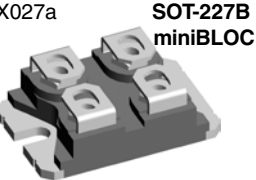
Part Type	V <sub>DSS</sub> V	I <sub>D(cont)</sub> Chip T <sub>C</sub> = 25°C A	R <sub>DS(on)</sub> T <sub>J</sub> = 25°C Ω	C <sub>iss</sub> typ pF	Q <sub>g</sub> typ nC	t <sub>rr</sub> typ ns	R <sub>thJC</sub> K/W	P <sub>D</sub> W	Fig. No.	Package style Outline drawings on pages O-30...O-55
<b>IXFX 32N90P</b>	900	32	0.3	10600	215	300	0.13	960	X015a	X005a <b>TO-220AB</b> 
<b>IXFN 40N90P</b>		33	0.21	14000	230	300	0.18	695	X027a	
<b>IXFX 40N90P</b>		40	0.21	14000	230	300	0.13	960	X015a	
<b>IXFK 40N90P</b>		40	0.21	14000	230	300	0.13	960	X020a	
<b>IXFN 52N90P</b>		43	0.16	19000	308	300	0.14	890	X027a	
<b>IXFB 52N90P</b>		52	0.16	19000	308	300	0.10	1250	X021a	
<b>IXFN 56N90P</b>		56	0.145	23000	375	300	0.125	1000	X027a	
<b>IXFP 05N100M</b>	1000	0.7	17	260	7.8	300	5.00	25	X007a	X007a <b>TO-220FPAB</b> 
<b>IXFP 4N100PM</b>		2.5	3.3	1456	26	300	2.20	57	X007a	
<b>IXFP 4N100P</b>		4	3.3	1456	26	300	0.83	150	X005a	
<b>IXFA 4N100P</b>		4	3.3	1456	26	300	0.83	150	X011b	
<b>IXFP 5N100P</b>		5	2.8	1830	33.4	200	0.50	250	X005a	
<b>IXFH 5N100P</b>		5	2.8	1830	33.4	200	0.50	250	X014a	
<b>IXFA 5N100P</b>		5	2.8	1830	33.4	200	0.50	250	X011b	
<b>IXFA 7N100P</b>		7	1.9	2590	47	300	0.42	300	X011b	
<b>IXFH 7N100P</b>		7	1.9	2590	47	300	0.42	300	X014a	
<b>IXFP 7N100P</b>		7	1.9	2590	47	300	0.42	300	X005a	
<b>IXFV 10N100P</b>		10	1.4	3030	58	300	0.33	380	X009a	
<b>IXFH 10N100P</b>		10	1.4	3030	56	300	0.33	380	X014a	
<b>IXFR20N100P</b>		11	0.64	7300	126	300	0.54	230	X016a	
<b>IXFV 12N100P</b>		12	1.05	4080	80	300	0.27	463	X009a	
<b>IXFH 12N100P</b>		12	1.05	4080	80	300	0.27	463	X014a	
<b>IXFR 26N100P</b>		15	0.43	11900	197	300	0.43	290	X016a	
<b>IXFV 15N100P</b>		15	0.76	5140	97	300	0.23	543	X009a	
<b>IXFH 15N100P</b>		15	0.76	5140	97	300	0.23	543	X014a	
<b>IXFR 32N100P</b>		18	0.34	14200	225	300	0.39	320	X016a	
<b>IXFH 20N100P</b>	20	0.57	7300	126	300	0.19	660	X014a		
<b>IXFT 20N100P</b>	20	0.57	7300	126	300	0.19	660	X019		
<b>IXFL 44N100P</b>	22	0.24	19000	305	300	0.35	357	X022e		
<b>IXFN 26N100P</b>	23	0.39	11900	197	300	0.21	595	X027a		
<b>IXFX 26N100P</b>	26	0.39	11900	197	300	0.16	780	X015a		
<b>IXFK 26N100P</b>	26	0.39	11900	197	300	0.16	780	X020a		
<b>IXFN 32N100P</b>	27	0.32	14200	225	300	0.18	690	X027a		
<b>IXFL38N100P</b>	29	0.23	24000	350	300	0.24	520	X022e		
<b>IXFX 32N100P</b>	32	0.32	14200	225	300	0.13	960	X015a		
<b>IXFK 32N100P</b>	32	0.32	14200	225	300	0.13	960	X020a		
<b>IXFN 44N100P</b>	37	0.22	19000	305	300	0.14	890	X027a		
<b>IXFN 38N100P</b>	38	0.21	24000	350	300	0.125	1000	X027a		
<b>IXFB 44N100P</b>	44	0.22	19000	305	300	0.10	1250	X021a		
<b>IXFL 40N110P</b>	1100	21	0.28	19000	310	300	0.35	357	X022e	X022e <b>ISOPLUS264/i5-pac</b> 
<b>IXFL 36N110P</b>		26	0.26	23000	350	300	0.24	520	X022e	
<b>IXFN 40N110P</b>		34	0.26	19000	310	300	0.14	890	X027a	
<b>IXFB 40N110P</b>		40	0.26	19000	310	300	0.10	1250	X021a	
<b>IXFP 6N120P</b>	1200	6	2.4	2830	92	300	0.50	250	X005a	X027a <b>SOT-227B miniBLOC</b> 
<b>IXFH 6N120P</b>		6	2.4	2830	92	300	0.50	250	X014a	
<b>IXFA 6N120P</b>		6	2.4	2830	92	300	0.50	250	X011b	
<b>IXFR 16N120P</b>		9	1.04	6900	120	300	0.54	230	X016a	
<b>IXFV 12N120P</b>		12	1.35	6500	103	300	0.23	543	X009a	
<b>IXFH 12N120P</b>		12	1.35	5400	103	300	0.23	543	X014a	
<b>IXFR 20N120P</b>		13	0.63	12900	193	300	0.43	290	X016a	
<b>IXFR 26N120P</b>		15	0.5	14000	225	300	0.39	320	X016a	
<b>IXFH 16N120P</b>		16	0.95	6900	120	300	0.19	660	X014a	

# Polar™ HiPerFETs with Fast Intrinsic Diode

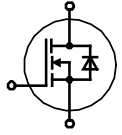

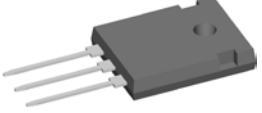
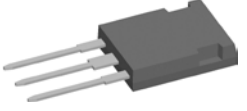
Part Type	V <sub>DSS</sub> V	I <sub>D(cont)</sub> Chip T <sub>C</sub> = 25°C A	R <sub>DS(on)</sub> T <sub>J</sub> = 25°C Ω	C <sub>iss</sub> typ pF	Q <sub>g</sub> typ nC	t <sub>rr</sub> typ ns	R <sub>thJC</sub> K/W	P <sub>D</sub> W	Fig. No.	Package style Outline drawings on pages O-30...O-55
IXFT 16N120P	1200	16	0.95	6900	120	300	0.19	660	X019	 X014a <b>TO-247AD</b>
IXFL 30N120P		18	0.38	19000	310	300	0.35	357	X022e	
IXFX 20N120P		20	0.57	11100	193	300	0.16	780	X015a	
IXFN 20N120P		20	0.57	11100	193	300	0.21	595	X027a	
IXFK 20N120P		20	0.57	11100	193	300	0.16	780	X020a	
IXFN 26N120P		23	0.46	14000	225	300	0.18	695	X027a	
IXFL 32N120P		24	0.34	21000	360	300	0.24	520	X022e	
IXFX 26N120P		26	0.46	14000	225	300	0.13	960	X015a	 X015a <b>PLUS247</b>
IXFK 26N120P		26	0.46	14000	225	300	0.13	960	X020a	
IXFB 30N120P		30	0.35	22500	310	300	0.10	1250	X021a	
IXFN 30N120P		30	0.35	19000	310	300	0.14	890	X027a	
IXFN 32N120P		32	0.31	21000	360	300	0.125	1000	X027a	

X019 **TO-268AA**



X021a **PLUS264**

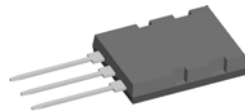

X020a **TO-264**

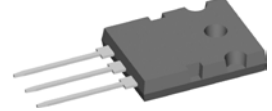

X022e **ISOPLUS264™ / i5-Pak**

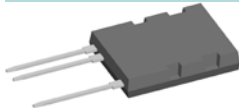





X027a **SOT-227B  
miniBLOC**



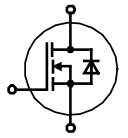

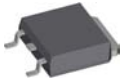
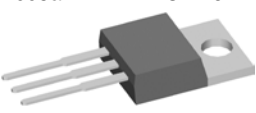
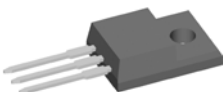

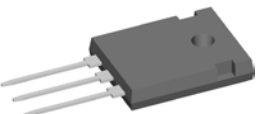
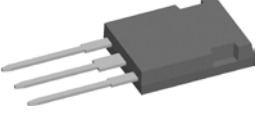
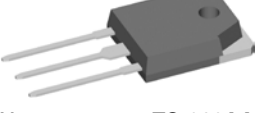
# PolarP2™ Power MOSFETs

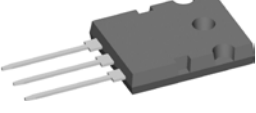
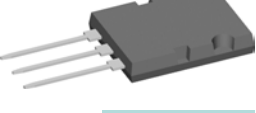
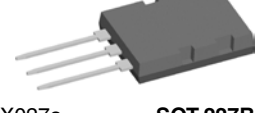

Part Type	V <sub>DSS</sub> V	I <sub>D(cont)</sub> Chip T <sub>C</sub> = 25°C A	R <sub>DS(on)</sub> T <sub>J</sub> = 25°C Ω	C <sub>iss</sub> typ. pF	Q <sub>g</sub> typ. nC	t <sub>rr</sub> typ. ns	R <sub>thJC</sub> K/W	P <sub>D</sub> W	Fig. No.	Package style Outline drawings on pages O-30...O-55
<b>PolarP2™ Standard Power MOSFETs</b>										
IXTH 450P2	500	16	0.33	2530	43	400	0.42	300	X014a	X004 <b>TO-252AA</b> 
IXTP 450P2		16	0.33	2530	43	400	0.42	300	X005a	X005a <b>TO-220AB</b> 
IXTQ 450P2		16	0.33	2530	43	400	0.42	300	X017a	
IXTA 460P2		24	0.27	2890	48	400	0.26	480	X011b	
IXTH 460P2		24	0.27	2890	48	400	0.26	480	X014a	
IXTP 460P2		24	0.27	2890	48	400	0.26	480	X005a	X007a <b>TO-220FPAB</b> 
IXTQ 460P2		24	0.27	2890	48	400	0.26	480	X017a	
IXTQ 470P2		42	0.145	5400	88	400	0.15	830	X017a	
IXTQ 480P2	52	0.12	6800	108	400	0.13	960	X017a		
<b>PolarP2™ HiPerFETs with Fast Intrinsic Diode</b>										
IXFQ 24N50P2	500	24	0.27	2890	48	200	0.26	480	X017a	X011b <b>TO-263AB</b> 
IXFH 42N50P2		42	0.145	5300	92	250	0.15	830	X014a	X014a <b>TO-247AD</b> 
IXFT 42N50P2		42	0.145	5300	92	250	0.15	830	X019	
IXFH 52N50P2		52	0.12	6800	113	250	0.13	960	X014a	X015a <b>PLUS247</b> 
IXFT 52N50P2		52	0.12	6800	113	250	0.13	960	X019	
IXFK 74N50P2		74	0.077	9900	165	250	0.089	1400	X020a	
IXFX 74N50P2		74	0.077	9900	165	250	0.089	1400	X015a	
IXFK 94N50P2		94	0.055	14200	228	250	0.096	1300	X020a	X017a <b>TO-3P</b> 
IXFX 94N50P2		94	0.055	14200	228	250	0.096	1300	X015a	
IXFB 120N50P2		120	0.043	19000	300	300	0.066	1890	X021a	X019 <b>TO-268AA</b> 

# PolarP3™ HiPerFETs

Part Type	V <sub>DSS</sub> V	I <sub>D(cont)</sub> Chip T <sub>C</sub> = 25°C A	R <sub>DS(on)</sub> T <sub>J</sub> = 25°C Ω	C <sub>iss</sub> typ. pF	Q <sub>g</sub> typ. nC	t <sub>rr</sub> typ. ns	R <sub>thJC</sub> K/W	P <sub>D</sub> W	Fig. No.	Package style Outline drawings on pages O-30...O-55
IXFH 94N30P3	300	94	0.036	5510	102	250	0.12	1040	X014a	X020a <b>TO-264</b> 
IXFQ 94N30P3		94	0.036	5510	102	250	0.12	1040	X017a	
IXFT 94N30P3		94	0.036	5510	102	250	0.12	1040	X019	
IXFL 210N30P3		108	0.016	16200	268	250	0.24	520	X022a	X021a <b>PLUS264</b> 
IXFK 120N30P3		120	0.027	8630	150	250	0.11	1130	X020a	
IXFX 120N30P3		120	0.027	8630	150	250	0.11	1130	X015a	
IXFK 150N30P3		150	0.019	12100	197	250	0.096	1300	X020a	
IXFX 150N30P3		150	0.019	12100	197	250	0.096	1300	X015a	X022a <b>ISOPLUS264™</b> 
IXFN 210N30P3	500	192	0.0145	16200	268	250	0.083	1500	X027a	X027a <b>SOT-227B miniBLOC</b> 
IXFB 210N30P3		210	0.0145	16200	268	250	0.066	1890	X021a	
IXFA 5N50P3		5	1.65	370	6.9	250	1.10	114	X011b	
IXFP 5N50P3		5	1.65	370	6.9	250	1.10	114	X005a	
IXFY 5N50P3		5	1.65	370	6.9	250	1.10	114	X004	
IXFA 8N50P3		8	0.8	705	13	250	0.69	180	X011b	
IXFP 20N50P3M	8	0.3	1800	36	250	2.15	58	X007a		
IXFP 8N50P3	8	0.8	705	13	250	0.69	180	X005a		
IXFA 16N50P3	16	0.36	1515	29	250	0.38	330	X011b		
IXFH 16N50P3	16	0.36	1515	29	250	0.38	330	X014a		

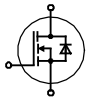

Part Type	V <sub>DSS</sub> V	I <sub>D(cont)</sub> Chip T <sub>C</sub> = 25°C A	R <sub>DS(on)</sub> T <sub>J</sub> = 25°C Ω	C <sub>iss</sub> typ. pF	Q <sub>g</sub> typ. nC	t <sub>rr</sub> typ. ns	R <sub>thJC</sub> K/W	P <sub>D</sub> W	Fig. No.	Package style Outline drawings on pages O-30...O-55	
<b>IXFP 16N50P3</b>	500	16	0.36	1515	29	250	0.38	330	X005a	X004 <b>TO-252AA</b>	
<b>IXFA 20N50P3</b>		20	0.3	1800	36	250	0.36	380	X011b		
<b>IXFH 20N50P3</b>		20	0.3	1800	36	250	0.36	380	X014a		
<b>IXFP 20N50P3</b>		20	0.3	1800	36	250	0.36	380	X005a	X005a <b>TO-220AB</b>	
<b>IXFQ 20N50P3</b>		20	0.3	1800	36	250	0.36	380	X017a		
<b>IXFA 26N50P3</b>		26	0.23	2220	42	250	0.25	500	X011b	X011b <b>TO-263AB</b>	
<b>IXFH 26N50P3</b>		26	0.23	2220	42	250	0.25	500	X014a		
<b>IXFP 26N50P3</b>		26	0.23	2220	42	250	0.25	500	X005a		
<b>IXFQ 26N50P3</b>		26	0.23	2220	42	250	0.25	500	X017a		
<b>IXFH 34N50P3</b>		34	0.17	3260	60	250	0.18	695	X014a	X014a <b>TO-247AD</b>	
<b>IXFQ 34N50P3</b>		34	0.17	3260	60	250	0.18	695	X017a		
<b>IXFH 50N50P3</b>		50	0.12	4335	85	250	0.13	960	X014a	X014a <b>TO-247AD</b>	
<b>IXFQ 50N50P3</b>		50	0.12	4335	85	250	0.13	960	X017a		
<b>IXFT 50N50P3</b>		50	0.12	4335	85	250	0.13	960	X019	X015a <b>PLUS247</b>	
<b>IXFH 60N50P3</b>		60	0.1	6250	96	250	0.12	1040	X014a		
<b>IXFQ 60N50P3</b>		60	0.1	6250	96	250	0.12	1040	X017a	X015a <b>PLUS247</b>	
<b>IXFT 60N50P3</b>		60	0.1	6250	96	250	0.12	1040	X019		
<b>IXFL 132N50P3</b>			63	0.043	18600	250	250	0.24	520	X022a	X016a <b>ISOPLUS247™</b>
<b>IXFK 78N50P3</b>			78	0.068	9900	147	250	0.11	1130	X020a	
<b>IXFX 78N50P3</b>		78	0.068	9900	147	250	0.11	1130	X015a	X016a <b>ISOPLUS247™</b>	
<b>IXFK 98N50P3</b>		98	0.05	13100	197	250	0.096	1300	X020a		
<b>IXFX 98N50P3</b>		98	0.05	13100	197	250	0.096	1300	X015a	X017a <b>TO-3P</b>	
<b>IXFN 132N50P3</b>		112	0.039	18600	250	250	0.083	1500	X027a		
<b>IXFB 132N50P3</b>		132	0.039	18600	250	250	0.066	1890	X021a		
<b>IXFA 4N60P3</b>	600	4	2.2	365	6.9	250	1.10	114	X011b	X017a <b>TO-3P</b>	
<b>IXFP 4N60P3</b>		4	2.2	365	6.9	250	1.10	114	X005a		
<b>IXFY 4N60P3</b>		4	2.2	365	6.9	250	1.10	114	X004		
<b>IXFA 7N60P3</b>		7	1.15	705	13.3	250	0.69	180	X011b	X019 <b>TO-268AA</b>	
<b>IXFP 7N60P3</b>		7	1.15	705	13.3	250	0.69	180	X005a		
<b>IXFA 14N60P3</b>		14	0.54	1480	25	250	0.38	327	X011b	X020a <b>TO-264</b>	
<b>IXFH 14N60P3</b>		14	0.54	1480	25	250	0.38	327	X014a		
<b>IXFP 14N60P3</b>		14	0.54	1480	25	250	0.38	327	X005a	X021a <b>PLUS264</b>	
<b>IXFA 16N60P3</b>		16	0.44	1830	36	250	0.36	347	X011b		
<b>IXFH 16N60P3</b>		16	0.44	1830	36	250	0.36	347	X014a	X022a <b>ISOPLUS264™</b>	
<b>IXFP 16N60P3</b>		16	0.44	1830	36	250	0.36	347	X005a		
<b>IXFA 22N60P3</b>		22	0.36	2600	38	250	0.25	500	X011b	X027a <b>SOT-227B miniBLOC</b>	
<b>IXFH 22N60P3</b>		22	0.36	2600	38	250	0.25	500	X014a		
<b>IXFP 22N60P3</b>		22	0.36	2600	38	250	0.25	500	X005a		
<b>IXFQ 22N60P3</b>		22	0.36	2600	38	250	0.25	500	X017a		
<b>IXFH 28N60P3</b>		28	0.26	3560	50	250	0.18	695	X014a	X021a <b>PLUS264</b>	
<b>IXFQ 28N60P3</b>		28	0.26	3560	50	250	0.18	695	X017a		
<b>IXFH 42N60P3</b>		42	0.185	5150	78	250	0.15	830	X014a	X022a <b>ISOPLUS264™</b>	
<b>IXFR 80N60P3</b>		48	0.076	13100	190	250	0.23	540	X016a		
<b>IXFH 50N60P3</b>		50	0.145	6300	94	250	0.12	1040	X014a	X027a <b>SOT-227B miniBLOC</b>	
<b>IXFQ 50N60P3</b>		50	0.145	6300	94	250	0.12	1040	X017a		
<b>IXFT 50N60P3</b>		50	0.145	6300	94	250	0.12	1040	X019		
<b>IXFK 64N60P3</b>		64	0.095	9900	145	250	0.11	1130	X020a	X021a <b>PLUS264</b>	
<b>IXFX 64N60P3</b>		64	0.095	9900	145	250	0.11	1130	X015a		
<b>IXFK 80N60P3</b>		80	0.07	13100	190	250	0.096	1300	X020a	X027a <b>SOT-227B miniBLOC</b>	
<b>IXFX 80N60P3</b>		80	0.07	13100	190	250	0.096	1300	X015a		
<b>IXFN 110N60P3</b>		90	0.056	18000	245	250	0.083	1500	X027a		
<b>IXFB 110N60P3</b>		110	0.056	18000	245	250	0.066	1890	X021a		

# Legacy (Standard) Power MOSFETs

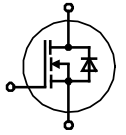

Part Type	V <sub>DSS</sub> V	I <sub>D(cont)</sub> Chip T <sub>C</sub> = 25°C A	R <sub>DS(on)</sub> T <sub>J</sub> = 25°C Ω	C <sub>iss</sub> typ. pF	Q <sub>g</sub> typ. nC	t <sub>rr</sub> typ. ns	R <sub>thJC</sub> K/W	P <sub>D</sub> W	Fig. No.
<b>IXTU 01N100</b>	1000	0.1	80	60	8	1500	3	25	X003
<b>IXTY 01N100</b>		0.1	80	60	8	1500	3	25	X004
<b>IXTP 05N100M</b>		0.7	17	260	7.8	710	5	25	X007a
<b>IXTP 05N100</b>		0.75	17	260	7.8	710	3.1	40	X005a
<b>IXTU 05N100</b>		0.75	17	260	7.8	710	3.1	40	X003
<b>IXTY 05N100</b>		0.75	17	260	7.8	710	3.1	40	X004
<b>IXTA 05N100</b>		0.75	17	260	7.8	710	3.1	40	X011b
<b>IXTP 1N100</b>		1.5	11	480	23	710	2.3	54	X005a
<b>IXTA 1N100</b>		1.5	11	480	23	710	2.3	54	X011b
<b>IXTP 2N100</b>		2	7	825	18	800	1.25	100	X005a
<b>IXTA 2N100</b>		2	7	825	18	800	1.25	100	X011b
<b>IXTX 24N100</b>		24	0.4	8700	267	850	0.22	568	X015a
<b>IXTP 3N120</b>	1200	3	4.5	1050	39	700	0.62	200	X005a
<b>IXTH 3N120</b>		3	4.5	1050	39	700	0.8	100	X014a
<b>IXTA 3N120</b>		3	4.5	1050	39	700	0.62	200	X011b
<b>IXTH 6N120</b>		6	2.4	1950	56	850	0.42	300	X014a
<b>IXTT 6N120</b>		6	2.4	1950	56	850	0.42	300	X019
<b>IXTH 3N150</b>	1500	3	7.3	1375	38.6	900	0.5	250	X014a
<b>IXTH 4N150</b>		4	6	1576	44.5	900	0.45	280	X014a
<b>IXTH 6N150</b>		6	3.5	2230	67	1500	0.23	540	X014a

Outline drawings on pages O-30...O-55

X003 **TO-251AA**

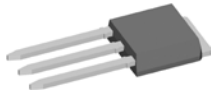

X004 **TO-252AA**



X005a **TO-220AB**

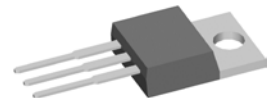

X007a **TO-220FPAB**

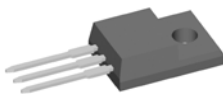

X011b **TO-263AB**



X014a **TO-247AD**

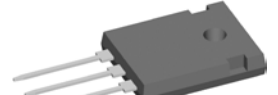

X015a **PLUS247**

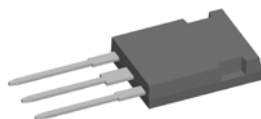



X019 **TO-268AA**

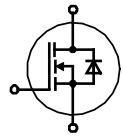

# Extended FBSOA Linear Power MOSFETs

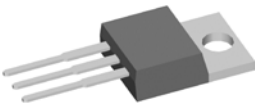

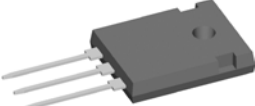
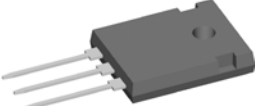
Part Type	V <sub>DSS</sub>	I <sub>D(cont)</sub> Chip T <sub>C</sub> = 25°C	R <sub>DS(on)</sub> T <sub>J</sub> = 25°C	C <sub>iss</sub> typ.	Q <sub>g</sub> typ.	t <sub>rr</sub>	R <sub>thJC</sub>	P <sub>D</sub>	Fig. No.	Package style
➤ New	V	A	Ω	pF	nC	ns	K/W	W		Outline drawings on pages O-30...O-55
IXTH 75N10L2	100	75	0.021	8100	215	180	0.31	400	X014a	X005a <b>TO-220AB</b> 
IXTT 75N10L2		75	0.021	8100	215	180	0.31	400	X019	
IXTH 110N10L2		110	0.018	10500	260	230	0.21	600	X014a	
IXTT 110N10L2		110	0.018	10500	260	230	0.21	600	X019	
IXTN 200N10L2		178	0.011	23000	540	245	0.15	830	X027a	
IXTX 200N10L2		200	0.011	23000	540	245	0.12	1040	X015a	
IXTK 200N10L2		200	0.011	23000	540	245	0.12	1040	X020a	
IXTH 60N20L2	200	60	0.045	10500	255	330	0.23	540	X014a	X011b <b>TO-263AB</b> 
IXTT 60N20L2		60	0.045	10500	255	330	0.23	540	X019	
IXTQ 60N20L2		60	0.045	10500	255	330	0.23	540	X017a	
IXTN 110N20L2		100	0.024	23000	500	420	0.17	735	X027a	
IXTX 110N20L2		110	0.024	23000	500	420	0.13	960	X015a	
IXTK 110N20L2		110	0.024	23000	500	420	0.13	960	X020a	
IXTX 90N25L2	250	90	0.033	23000	640	266	0.13	960	X015a	
IXTN 90N25L2		90	0.033	23000	640	266	0.17	735	X027a	
IXTK 90N25L2		90	0.033	23000	640	266	0.13	960	X020a	
➤ IXTA 15N50L2	500	15	0.48	4080	123	570	0.42	300	X011b	X014a <b>TO-247AD</b> 
IXTP 15N50L2		15	0.48	4080	123	570	0.42	300	X005a	
IXTH 15N50L2		15	0.48	4080	123	570	0.42	300	X014a	
IXTH 30N50L2		30	0.2	8100	240	500	0.31	400	X014a	
IXTT 30N50L2		30	0.2	8100	240	500	0.31	400	X019	
IXTQ 30N50L2		30	0.2	8100	240	500	0.31	400	X017a	
IXTH 40N50L2		40	0.17	10400	320	500	0.23	540	X014a	
IXTT 40N50L2		40	0.17	10400	320	500	0.23	540	X019	
IXTQ 40N50L2		40	0.17	10400	320	500	0.23	540	X017a	
IXTN 60N50L2		53	0.1	24000	610	980	0.17	735	X027a	
IXTX 60N50L2		60	0.1	24000	610	980	0.13	960	X015a	
IXTK 60N50L2		60	0.1	24000	610	980	0.13	960	X020a	
IXTH 30N60L2	600	30	0.24	10700	335	710	0.23	540	X014a	
IXTT 30N60L2		30	0.24	10700	335	710	0.23	540	X019	
IXTQ 30N60L2		30	0.24	10700	335	710	0.23	540	X017a	

X027a **SOT-227B miniBLOC**



X019 **TO-268AB**



X017a **TO-3P**

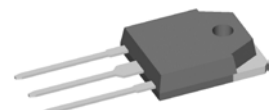

# Depletion-Mode MOSFETs

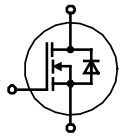

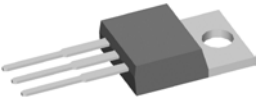
Part Type	V <sub>DSS</sub>	I <sub>D(cont)</sub> Chip T <sub>C</sub> = 25°C	R <sub>DS(on)</sub> T <sub>J</sub> = 25°C	V <sub>GS(off)</sub> max.	C <sub>iss</sub> typ.	C <sub>rss</sub> typ.	Q <sub>g</sub> typ.	P <sub>D</sub>	Fig. No.	Package style	
➤ New	V	A	Ω	V	pF	pF	nC	W		Outline drawings on pages O-30...O-55	
➤ IXTH 16N10D2	100	16	0.064	-4	5700	940	225	695	X014a	X004	TO-252AA 
IXTT 16N10D2		16	0.064	-4	5700	940	225	695	X019		
IXTH 16N20D2	200	16	0.073	-4	5500	607	208	695	X014a		
IXTT 16N20D2		16	0.073	-4	5500	607	208	695	X019		
IXTP 08N50D2	500	0.8	4.6	-4	312	11	12.7	60	X005a	X005a	TO-220AB 
IXTY 08N50D2		0.8	4.6	-4	312	11	12.7	60	X004		
IXTA 08N50D2		0.8	4.6	-4	312	11	12.7	60	X011b		
IXTP 1R6N50D2		1.6	2.3	-4	645	16.5	23.7	100	X005a		
IXTY 1R6N50D2		1.6	2.3	-4	645	16.5	23.7	100	X004		
IXTA 1R6N50D2		1.6	2.3	-4	645	16.5	23.7	100	X011b		
IXTP 3N50D2		3	1.5	-4	1070	24	40	125	X005a		
IXTA 3N50D2		3	1.5	-4	1070	24	40	125	X011b		
IXTP 6N50D2		6	0.5	-4	2800	64	96	300	X005a		
IXTH 6N50D2		6	0.5	-4	2800	64	96	300	X014a		
IXTA 6N50D2		6	0.5	-4	2800	64	96	300	X011b		
IXTH 16N50D2		16	0.24	-4	5250	130	199	695	X014a		
IXTT 16N50D2		16	0.24	-4	5250	130	199	695	X019		
IXTP 08N100D2	1000	0.8	21	-4	325	6.5	14.6	60	X005a		
IXTY 08N100D2		0.8	21	-4	325	6.5	14.6	60	X004		
IXTA 08N100D2		0.8	21	-4	325	6.5	14.6	60	X011b		
IXTP 1R6N100D2		1.6	10	-4.5	645	11	27	100	X005a		
IXTY 1R6N100D2		1.6	10	-4.5	645	11	27	100	X004		
IXTA 1R6N100D2		1.6	10	-4.5	645	11	27	100	X011b		
IXTP 3N100D2		3	5.5	-4.5	1020	17	37.5	125	X005a		
IXTA 3N100D2		3	5.5	-4.5	1020	17	37.5	125	X011b		
➤ IXTA 3N100D2HV		3	6	-4.5	1020	17	37.5	125	X011c		
IXTP 6N100D2		6	2.2	-4.5	2650	41	95	300	X005a		
IXTH 6N100D2		6	2.2	-4.5	2650	41	95	300	X014a		
IXTA 6N100D2		6	2.2	-4.5	2650	41	95	300	X011b		
➤ IXTT 10N100D2		10	1.5	-4.5	5320	70	200	695	X019		
➤ IXTH 10N100D2		10	1.5	-4.5	5320	70	200	695	X014a		
➤ IXTT 2N170D2	1700	2	6.5	-4	3650	80	110	568	X019		
➤ IXTH 2N170D2		2	6.5	-4	3650	80	110	568	X014a		

X019

TO-268AA



X014a

TO-247AD

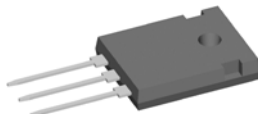







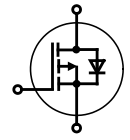

X011c

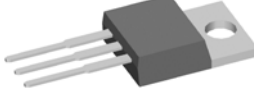
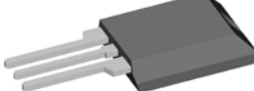
TO-263AB

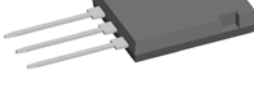
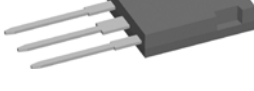
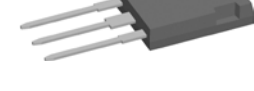
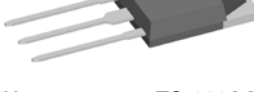

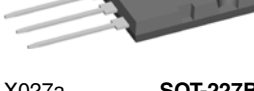





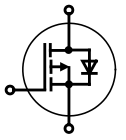

# PolarP™ P-Channel Power MOSFETs

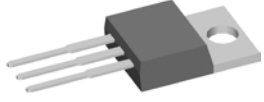

Part Type	V <sub>DSS</sub> V	I <sub>D(cont)</sub> Chip T <sub>C</sub> = 25°C A	R <sub>DS(on)</sub> T <sub>J</sub> = 25°C Ω	C <sub>iss</sub> typ. pF	Q <sub>g</sub> typ. nC	t <sub>rr</sub> typ. ns	R <sub>thJC</sub> K/W	P <sub>D</sub> W	Fig. No.	Package style Outline drawings on pages O-30...O-55
<b>IXTX 32P60P</b>	-600	-32	0.35	11100	196	480	0.14	890	X015a	X005a <b>TO-220AB</b> 
<b>IXTN 32P60P</b>		-32	0.35	11100	196	480	0.14	890	X027a	
<b>IXTK 32P60P</b>		-32	0.35	11100	196	480	0.14	890	X020a	
<b>IXTR 32P60P</b>		-18	0.385	11100	196	480	0.4	310	X016a	
<b>IXTH 16P60P</b>	-600	-16	0.72	5120	92	440	0.27	460	X005a	X010a <b>ISOPLUS220™</b> 
<b>IXTT 16P60P</b>		-16	0.72	5120	92	440	0.27	460	X019	
<b>IXTR 16P60P</b>		-10	0.79	5120	92	440	0.66	190	X016a	
<b>IXTX 40P50P</b>	-500	-40	0.23	11500	205	477	0.14	890	X015a	X011b <b>TO-263AB</b> 
<b>IXTN 40P50P</b>		-40	0.23	11500	205	477	0.14	890	X027a	
<b>IXTK 40P50P</b>		-40	0.23	11500	205	477	0.14	890	X020a	
<b>IXTR 40P50P</b>		-22	0.26	11500	205	477	0.4	312	X016a	
<b>IXTH 20P50P</b>	-500	-20	0.45	5120	103	406	0.27	460	X014a	X014a <b>TO-247AD</b> 
<b>IXTT 20P50P</b>		-20	0.45	5120	103	406	0.27	460	X019	
<b>IXTR 20P50P</b>		-13	0.49	5120	103	406	0.66	190	X016a	
<b>IXTP 10P50P</b>	-500	-10	1.00	2670	50	414	0.5	300	X005a	X015a <b>PLUS247</b> 
<b>IXTH 10P50P</b>		-10	1.00	2670	50	414	0.5	300	X005a	
<b>IXTA 10P50P</b>		-10	1.00	2670	50	414	0.5	300	X011b	
<b>IXTQ 10P50P</b>		-10	1.00	2670	50	414	0.5	300	X017a	
<b>IXTX 90P20P</b>	-200	-90	0.044	12000	205	315	0.14	890	X015a	X016a <b>ISOPLUS247™</b> 
<b>IXTN 90P20P</b>		-90	0.044	12000	205	315	0.14	890	X027a	
<b>IXTK 90P20P</b>		-90	0.044	12000	205	315	0.14	890	X020a	
<b>IXTR 90P20P</b>		-53	0.048	12000	205	315	0.4	312	X016a	
<b>IXTH 48P20P</b>	-200	-48	0.085	5400	103	260	0.27	462	X014a	X017a <b>TO-3P</b> 
<b>IXTT 48P20P</b>		-48	0.085	5400	103	260	0.27	462	X019	
<b>IXTR 48P20P</b>		-30	0.093	5400	103	260	0.66	190	X016a	
<b>IXTP 26P20P</b>	-200	-26	0.17	2740	56	240	0.42	300	X005a	X019 <b>TO-268AA</b> 
<b>IXTH 26P20P</b>		-26	0.17	2740	56	240	0.42	300	X014a	
<b>IXTA 26P20P</b>		-26	0.17	2740	56	240	0.42	300	X011b	
<b>IXTQ 26P20P</b>		-26	0.17	2740	56	240	0.42	300	X017a	
<b>IXTP 36P15P</b>	-150	-36	0.11	3100	55	228	0.42	300	X005a	X020a <b>TO-264</b> 
<b>IXTH 36P15P</b>		-36	0.11	3100	55	228	0.42	300	X014a	
<b>IXTA 36P15P</b>		-36	0.11	3100	55	228	0.42	300	X011b	
<b>IXTQ 36P15P</b>		-36	0.11	3100	55	228	0.42	300	X017a	
<b>IXTC 36P15P</b>	-150	-22	0.12	2950	55	150	1	150	X010a	X027a <b>SOT-227B miniBLOC</b> 
<b>IXTR 36P15P</b>		-22	0.12	2950	55	150	1	150	X016a	
<b>IXTX 170P10P</b>	-100	-170	0.012	12600	240	176	0.14	890	X015a	X027a <b>SOT-227B miniBLOC</b> 
<b>IXTN 170P10P</b>		-170	0.012	12600	240	176	0.14	890	X027a	
<b>IXTK 170P10P</b>		-170	0.012	12600	240	176	0.14	890	X020a	
<b>IXTR 170P10P</b>		-108	0.013	12600	240	176	0.4	312	X016a	
<b>IXTH 90P10P</b>	-100	-90	0.025	5800	120	144	0.27	462	X014a	X027a <b>SOT-227B miniBLOC</b> 
<b>IXTT 90P10P</b>		-90	0.025	5800	120	144	0.27	462	X019	
<b>IXTR 90P10P</b>		-57	0.027	5800	120	144	0.66	190	X016a	
<b>IXTP 52P10P</b>	-100	-52	0.05	2845	60	120	0.42	300	X005a	X027a <b>SOT-227B miniBLOC</b> 
<b>IXTH 52P10P</b>		-52	0.05	2845	60	120	0.42	300	X014a	
<b>IXTA 52P10P</b>		-52	0.05	2845	60	120	0.42	300	X011b	
<b>IXTQ 52P10P</b>		-52	0.05	2845	60	120	0.42	300	X017a	

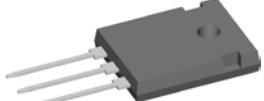
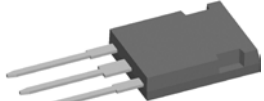
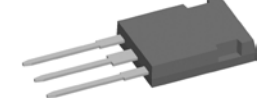
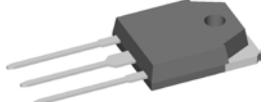

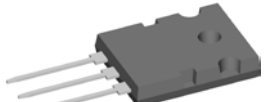
# TrenchP™ P-Channel MOSFETs

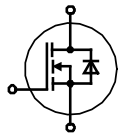

Part Type	V <sub>DSS</sub>	I <sub>D(cont)</sub> Chip T <sub>C</sub> = 25°C	R <sub>DS(on)</sub> T <sub>J</sub> = 25°C	C <sub>iss</sub> typ.	Q <sub>g</sub> typ.	t <sub>rr</sub> typ. (*max)	R <sub>thJC</sub>	P <sub>D</sub>	Fig. No.	Package style Outline drawings on pages O-30...O-55	
➤ New	V	A	Ω	pF	nC	ns	K/W	W			
IXTK 120P20T	-200	-120	0.03	73000	740	*300	0.12	1040	X020a	X004	<b>TO-252AA</b> 
IXTX 120P20T		-120	0.03	73000	740	*301	0.12	1040	X015a		
IXTN 120P20T		-106	0.03	73000	740	*302	0.15	830	X027a		
<b>IXTR 120P20T</b>		<b>-90</b>	<b>0.032</b>	<b>73000</b>	<b>740</b>	<b>*303</b>	<b>0.21</b>	<b>595</b>	<b>X016a</b>		
IXTH 68P20T		-68	0.055	33400	380	245	0.22	568	X014a	X005a	<b>TO-220AB</b> 
IXTT 68P20T		-68	0.055	33400	380	245	0.22	568	X019		
<b>IXTR 68P20T</b>		<b>-44</b>	<b>0.064</b>	<b>33400</b>	<b>380</b>	<b>245</b>	<b>0.46</b>	<b>270</b>	<b>X016a</b>		
IXTA 32P20T		-32	0.13	14500	185	190	0.42	300	X011b	X011b	<b>TO-263AB</b> 
IXTP 32P20T		-32	0.13	14500	185	190	0.42	300	X005a		
IXTH 32P20T		-32	0.13	14500	185	190	0.42	300	X014a		
IXTQ 32P20T		-32	0.13	14500	185	190	0.42	300	X017a		
IXTP 44P15T	-150	-44	0.065	13400	175	140	0.42	298	X005a	X014a	<b>TO-247AD</b> 
IXTH 44P15T		-44	0.065	13400	175	140	0.42	298	X014a		
IXTA 44P15T		-44	0.065	13400	175	140	0.42	298	X011b		
IXTQ 44P15T		-44	0.065	13400	175	140	0.42	298	X017a		
IXTP 15P15T		-15	0.24	3650	48	116	0.83	150	X005a	X004	<b>PLUS247</b> 
IXTY 15P15T		-15	0.24	3650	48	116	0.83	150	X004		
IXTA 15P15T		-15	0.24	3650	48	116	0.83	150	X011b		
IXTP 10P15T		-10	0.35	2210	36	120	1.5	83	X005a		
IXTY 10P15T		-10	0.35	2210	36	120	1.5	83	X004	X015a	<b>PLUS247</b>
IXTA 10P15T		-10	0.35	2210	36	120	1.5	83	X011b		
IXTK 210P10T	-100	-210	0.0075	69500	740	*200	0.12	1040	X020a	X016a	<b>ISOPLUS247™</b> 
IXTN 210P10T		-210	0.0075	69500	740	*201	0.15	830	X027a		
IXTX 210P10T		-210	0.0075	69500	740	*202	0.12	1040	X015a		
<b>IXTR 210P10T</b>		<b>-158</b>	<b>0.008</b>	<b>69500</b>	<b>740</b>	<b>*203</b>	<b>0.32</b>	<b>390</b>	<b>X016a</b>		
IXTH 140P10T		-140	0.012	31400	400	130	0.22	568	X014a	X016a	<b>ISOPLUS247™</b>
IXTT 140P10T		-140	0.012	31400	400	130	0.22	568	X019		
<b>IXTR 140P10T</b>		<b>-90</b>	<b>0.013</b>	<b>31400</b>	<b>400</b>	<b>130</b>	<b>0.46</b>	<b>270</b>	<b>X016a</b>		
IXTP 76P10T		-76	0.025	13700	197	70	0.42	298	X005a	X017a	<b>TO-3P</b> 
IXTH 76P10T		-76	0.025	13700	197	70	0.42	298	X014a		
IXTA 76P10T		-76	0.025	13700	197	70	0.42	298	X011b		
IXTP 26P10T		-26	0.09	3820	52	70	0.83	150	X005a		
IXTY 26P10T		-26	0.09	3820	52	70	0.83	150	X004	X004	<b>TO-268AA</b> 
IXTA 26P10T		-26	0.09	3820	52	70	0.83	150	X011b		
IXTP 18P10T		-18	0.12	2100	39	62	1.5	83	X005a		
IXTY 18P10T		-18	0.12	2100	39	62	1.5	83	X004		
IXTA 18P10T		-18	0.12	2100	39	62	1.5	83	X011b	X019	<b>TO-268AA</b>
IXTP 96P085T	-85	-96	0.013	13100	180	55	0.42	298	X005a	X020a	<b>TO-264</b> 
IXTH 96P085T		-96	0.013	13100	180	55	0.42	298	X014a		
IXTA 96P085T		-96	0.013	13100	180	55	0.42	298	X011b		
IXTP 24P085T		-24	0.065	2090	41	40	1.5	83	X005a		
IXTA 24P085T		-24	0.065	2090	41	40	1.5	83	X011b		
IXTP 120P065T	-65	-120	0.01	13200	185	53	0.42	298	X005a	X005a	
IXTH 120P065T		-120	0.01	13200	185	53	0.42	298	X014a		
IXTA 120P065T		-120	0.01	13200	185	53	0.42	298	X011b		
IXTP 28P065T		-28	0.045	2030	46	31	1.5	83	X005a		
IXTA 28P065T		-28	0.045	2030	46	31	1.5	83	X011b		
IXTP 140P05T	-50	-140	0.009	13500	200	53	0.42	298	X005a	X027a	<b>SOT-227B miniBLOC</b> 
IXTH 140P05T		-140	0.009	13500	200	53	0.42	298	X014a		
IXTA 140P05T		-140	0.009	13500	200	53	0.42	298	X011b		
IXTP 48P05T		-48	0.03	3660	53	30	0.83	150	X005a		
IXTY 48P05T		-48	0.03	3660	53	30	0.83	150	X004	X004	<b>SOT-227B miniBLOC</b>
IXTA 48P05T		-48	0.03	3660	53	30	0.83	150	X011b		
IXTP 32P05T		-32	0.039	1975	46	26	1.5	83	X005a		
IXTY 32P05T		-32	0.039	1975	46	26	1.5	83	X004		
IXTA 32P05T		-32	0.039	1975	46	26	1.5	83	X011b		

# Q3-Class HiPerFET™ Power MOSFETs

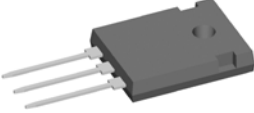
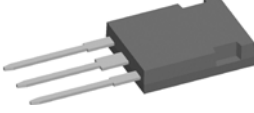
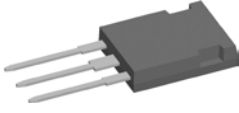
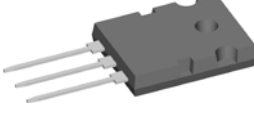
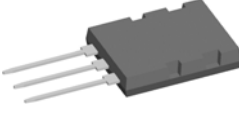

Part Type	V <sub>DSS</sub>	I <sub>D(cont)</sub> Chip T <sub>C</sub> = 25°C	R <sub>DS(on)</sub> T <sub>J</sub> = 25°C	C <sub>iss</sub> typ.	Q <sub>g</sub> typ.	t <sub>rr</sub> typ.	R <sub>thJC</sub>	P <sub>D</sub>	Fig. No.	Package style Outline drawings on pages O-30...O-55
➤ New	V	A	Ω	pF	nC	ns	K/W	W		
IXFH 70N20Q3	200	70	0.04	3150	67	250	0.18	690	X014a	 <b>TO-247AD</b>
IXFT 70N20Q3		70	0.04	3150	67	250	0.18	690	X019	
IXFH 50N30Q3		50	0.08	3160	65	250	0.18	690	X014a	
IXFT 50N30Q3		50	0.08	3160	65	250	0.18	690	X019	
IXFT 70N30Q3		70	0.054	4735	98	250	0.15	830	X019	
IXFH 70N30Q3		70	0.054	4735	98	250	0.15	830	X014a	
IXFR 44N50Q3	500	25	0.154	4800	93	250	0.41	300	X016a	 <b>PLUS247</b>
IXFT 30N50Q3		30	0.2	3200	62	250	0.18	690	X019	
IXFH 30N50Q3		30	0.2	3200	62	250	0.18	690	X014a	
IXFH 44N50Q3		44	0.14	4800	93	250	0.15	830	X014a	
IXFT 44N50Q3		44	0.14	4800	93	250	0.15	830	X019	
IXFR 64N50Q3	600	45	0.094	6950	145	250	0.25	500	X016a	 <b>ISOPLUS247™</b>
IXFR 80N50Q3		50	0.072	10000	200	250	0.22	570	X016a	
IXFN 80N50Q3		63	0.065	10000	200	250	0.16	780	X027a	
IXFK 64N50Q3		64	0.085	6950	145	250	0.125	1000	X020a	
IXFX 64N50Q3		64	0.085	6950	145	250	0.125	1000	X015a	
IXFX 80N50Q3		80	0.065	10000	200	250	0.10	1250	X015a	
IXFK 80N50Q3		80	0.065	10000	200	250	0.10	1250	X020a	
IXFN 100N50Q3		82	0.049	13800	255	250	0.13	960	X027a	
IXFB 100N50Q3		100	0.049	13800	255	250	0.08	1560	X021a	
IXFR 48N60Q3		600	32	0.154	7020	140	300	0.25	500	
IXFR 64N60Q3	42		0.104	9930	190	300	0.22	568	X016a	
IXFK 48N60Q3	48		0.14	7020	140	300	0.125	1000	X020a	
IXFX 48N60Q3	48		0.14	7020	140	300	0.125	1000	X015a	
IXFK 64N60Q3	64		0.095	9930	190	300	0.10	1250	X020a	
IXFX 64N60Q3	64		0.095	9930	190	300	0.10	1250	X015a	
IXFN 82N60Q3	66		0.075	13500	275	300	0.13	960	X027a	
IXFB 82N60Q3	82		0.075	13500	275	300	0.08	1560	X021a	
IXFR 32N80Q3	800	24	0.3	6940	140	300	0.25	500	X016a	 <b>TO-264</b>
IXFK 32N80Q3		32	0.27	6940	140	300	0.125	1000	X020a	
IXFX 32N80Q3		32	0.27	6940	140	300	0.125	1000	X015a	
IXFN 44N80Q3		37	0.19	10950	185	300	0.16	780	X027a	
IXFX 44N80Q3		44	0.19	10950	185	300	0.10	1250	X015a	
IXFK 44N80Q3		44	0.19	10950	185	300	0.10	1250	X020a	
IXFN 62N80Q3		49	0.14	13600	270	300	0.13	960	X027a	
IXFB 62N80Q3	62	0.14	13600	270	300	0.08	1560	X021a		
IXFR 15N100Q3	1000	10	1.2	3250	64	250	0.31	400	X016a	 <b>PLUS264</b>
IXFT 15N100Q3		15	1.05	3250	64	250	0.18	690	X019	
IXFH 15N100Q3		15	1.05	3250	64	250	0.18	690	X014a	
IXFH 18N100Q3		18	0.66	4890	90	300	0.15	830	X014a	
IXFT 18N100Q3	18	0.66	4890	90	300	0.15	830	X019		
IXFR 24N100Q3	1000	18	0.49	7200	140	300	0.25	500	X016a	 <b>SOT-227B miniBLOC</b>
IXFR 32N100Q3		23	0.35	10900	195	300	0.22	570	X016a	
IXFK 24N100Q3		24	0.44	7200	140	300	0.125	1000	X020a	
IXFX 24N100Q3		24	0.44	7200	140	300	0.125	1000	X015a	
IXFN 32N100Q3		28	0.32	10900	195	300	0.16	780	X027a	
IXFK 32N100Q3		32	0.32	10900	195	250	0.10	1250	X020a	
IXFX 32N100Q3		32	0.32	10900	195	250	0.10	1250	X015a	
IXFN 44N100Q3		38	0.22	13600	264	300	0.13	960	X027a	
IXFB 44N100Q3		44	0.22	13600	264	300	0.08	1560	X021a	



# Very High Voltage Power MOSFETs (2.5 - 4 kV)

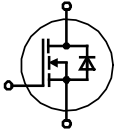

Part Type	V <sub>DSS</sub>	I <sub>D(cont)</sub> Chip T <sub>C</sub> = 25°C	R <sub>DS(on)</sub> T <sub>J</sub> = 25°C	C <sub>iss</sub> typ.	Q <sub>g</sub> typ.	t <sub>rr</sub> typ.	R <sub>thJC</sub>	P <sub>D</sub>	Fig. No.
➤ New	V	A	Ω	pF	nC	ns	K/W	W	
IXTA 02N250	2500	0.2	450	116	7.4	1500	1.50	83	X011b
IXTH 02N250		0.2	450	116	7.4	1500	1.50	83	X014a
IXTF 1N250		1.0	40	1660	41	2500	1.13	110	X024c
IXTH 1N250		1.5	40	1660	41	2500	0.50	250	X014a
IXTT 1N250HV		1.5	40	1660	41	2500	0.50	250	X019a
IXTK 5N250		5.0	8.8	8560	200	1200	0.13	960	X020a
IXTN 5N250		5.0	8.8	8560	200	1200	0.18	700	X027a
IXTX 5N250		5.0	8.8	8560	200	1200	0.13	960	X015a
IXTT 02N450HV	4500	0.2	750	256	10.4	1600	1.10	113	X019a
IXTA 02N450HV		0.2	750	256	10.4	1600	1.10	113	X011c
IXTF 02N450		0.2	750	256	10.4	1600	1.60	78	X024c
IXTF 1N450		0.9	85	1730	40	1750	0.77	165	X024c
IXTT 1N450HV		1.0	85	1730	40	1750	0.24	520	X019a
IXTL 2N450		2.0	23	6900	156	1750	0.56	220	X022e

Outline drawings  
on pages O-30...O-55

X011b

TO-263



X011c

TO-263



X020a

TO-264

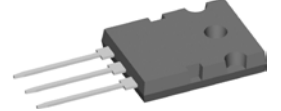

X014a

TO-247AD

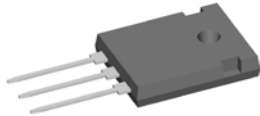

X015a

PLUS247

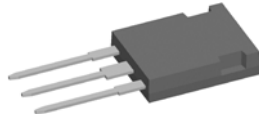

X019

TO-268AA



X022e **ISOPLUS264™ / i5-Pak**

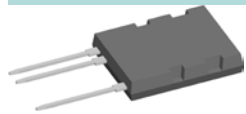

X024c **ISOPLUS i4-PAC™**

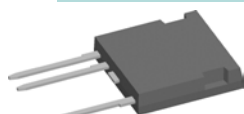

X027a

**SOT-227B  
miniBLOC**



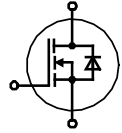

## K Series - CoolMOS™

Part Type	V <sub>DSS</sub>	I <sub>D25</sub> T <sub>C</sub> = 25°C	R <sub>DS(on)</sub> T <sub>J</sub> = 25°C	Q <sub>g</sub>	R <sub>thJC</sub>	V <sub>ISOL</sub> RMS	Fig. No.	Package style Outline drawings on pages O-30...O-55
○ Not for new design				typ.				
➤ New	V	A	Ω	nC	K/W	V		
<b>C3 Series</b>								X005a <b>TO-220AB</b>
<b>IXKC 20N60C</b>	600	14	0.19	80	1.00	2500	X010a	
○ IXKC 40N60C		24	0.096	160	0.50	2500	X010a	
<b>IXKR 40N60C</b>		38	0.07	250	0.45	2500	X016a	
<b>IXKN 40N60C</b>		40	0.07	250	0.43	2500	X027a	
<b>IXKH 47N60C</b>		47	0.07	250	0.30	-	X014a	
<b>IXKN 75N60C</b>		75	0.036	500	0.22	2500	X027a	
<b>IXKK 85N60C</b>		85	0.036	540	0.18	-	X020a	
<b>IXKC 13N80C</b>	800	13	0.29	85	0.96	2500	X010a	
○ IXKC 25N80C		20	0.15	180	0.90	2500	X010a	
<b>IXKR 25N80C</b>		25	0.15	170	0.50	2500	X016a	
<b>IXKN 45N80C</b>		44	0.074	335	0.33	2500	X027a	
<b>C5 Series</b>								
<b>IXKP 10N60C5</b>	600	10	0.385	17	1.15	-	X005a	
○ IXKP 13N60C5M		6.5	0.3	22	3.85	-	X007a	
○ IXKP 20N60C5		20	0.2	32	0.60	-	X005a	
○ IXKH 20N60C5		20	0.2	32	0.60	-	X014a	
<b>IXKC 15N60C5</b>		15	0.165	40	1.10	2500	X010a	
○ IXKP 24N60C5		24	0.165	40	0.50	-	X005a	
○ IXKP 24N60C5M		8.5	0.165	40	3.65	-	X007a	
○ IXKH 24N60C5		24	0.165	40	0.50	-	X014a	
○ IXKH 30N60C5		30	0.125	53	0.40	-	X014a	
<b>IXKH 35N60C5</b>		35	0.1	60	0.35	-	X014a	
<b>IXKR 47N60C5</b>		47	0.045	150	0.45	2500	X016a	
<b>IXKH 70N60C5</b>		70	0.045	150	0.20	-	X014a	
<b>IXKT 70N60C5</b>		66	0.045	150	0.23	-	X019	
<p><b>CoolMOS™ Configurations in i4-PAC™</b></p> <p>MKE...R...DCG... IXKF FDM FMD LKK</p>								
<p><b>CoolMOS™ Configurations in ISOPLUS264™ Package</b></p> <p>LKK 47-06C5</p>								X022c <b>ISOPLUS264</b>
<b>Part Type</b>	V <sub>DSS</sub>	I <sub>D25</sub> T <sub>C</sub> = 25°C	R <sub>DS(on) max.</sub> T <sub>J</sub> = 25°C	Q <sub>g</sub>	R <sub>thJC</sub>		Fig. No.	
◇ under development				typ.		<b>Config.</b>		
➤ New	V	A	Ω	nC	K/W			
<b>IXKF 40N60SCD1</b>	600	38	0.07	250	0.45	single	X024c	
➤ IXKF 40N60SCH1		41	0.07	250	0.45	single		
◇ IXKF 40N60SCC1 <sup>1)</sup>		41	0.07	250	0.45	single		
<b>MKE 11R600DCGFC<sup>1)</sup></b>	600	15	0.165	40	1.1	boost	X024a	
<b>FMD 15-06KC5</b>		15	0.165	40	1.1	boost		
<b>FMD 40-06KC</b>		38	0.07	250	0.45	boost		
<b>FMD 47-06KC5</b>		47	0.045	150	0.45	boost		
<b>FDM 15-06KC5</b>	600	15	0.165	40	1.1	buck	X027a	
<b>FDM 47-06KC5</b>		47	0.045	150	0.45	buck		
<sup>1)</sup> with SiC Boost Diode								
<b>Configuration in ISOPLUS264™ Package</b>								
<b>LKK 47-06C5</b>	600	2 x 47	0.045	150	0.45	dual	X022c	



# MOSFET Modules

## Trench MOSFET Technology

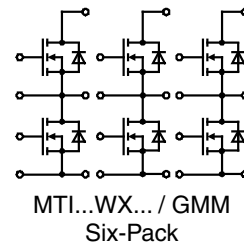
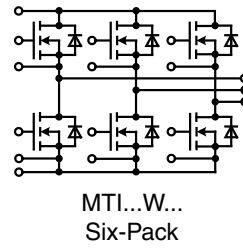
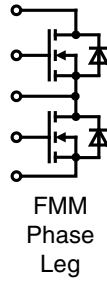
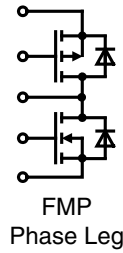
- very low  $R_{DSon}$
- fast body diode

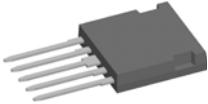

MMIX1T.../  
MMIX1F...  
MTC with  
Temp. Sensor

Part Type	$V_{DSS}$	$I_{D25}$ $T_C = 25^\circ C$	$I_{D90}$ $T_C = 90^\circ C$	$R_{DSon}$ typ. $T_J = 25^\circ C$	$C_{iss}$ typ	$Q_g$ typ	$R_{thJC}$ K/W	Fig. No.	Package style Outline drawings on pages O-30...O-55
◇ under development									
➤ new	V	A	A	mΩ	nF	nC			
<b>Single high current Switch</b>									
MMIX 1T600N04T2	40	600	440	1.3	40	590	0.18	X031a	X024a <b>ISOPLUS i4-PAC™</b>
MMIX 1T550N055T2	55	550	405	1.3	40	595	0.18		
MMIX 1F520N075T2	75	500	370	1.6	41	545	0.18		
<b>Single high current Switch with NTC</b>									
◇ MTC 960X55TGD	55	2x 640	2x 480	1.1	2x 40	2x 595	0.16	X026d	
◇ MTC 840X75TGD	75	2x 550	2x 420	1.3	2x 40	2x 545	0.16		
<b>Phase Leg Configuration</b>									
FMM 150-0075X2F	75	120	87	5.8	10.5	178	0.88	X024a	X031a <b>SMPD-X</b>
➤ FMP 76-010T ①	±100	-54 / 62	-	24 / 11	40	20	0,95 / 1.4		
➤ FMM 60-02TF	200	33	-	40	46	42	1.0		
➤ FMM 50-025TF	550	30	-	50	25	25	1.0		
① high side switch: p-channel; low side switch: n-channel									
<b>Six-Pack Configuration</b>									
➤ MTI 200WX75GD	75	265	200	1.1	10.8	155	0.85	X026d	
➤ MTI 85W100GC	100	110	83	3.2	6.3	90	1.45	X026c	
➤ MTI 145WX100GD	100	190	145	1.7	11	155	0.85	X026d	
GMM 3x60-015X2	150	50	38	19	5.8	97	1.00		

X026d **ISOPLUS-DIL™**

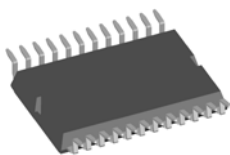

X026c **ISOPLUS-DIL™**

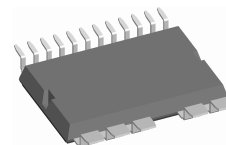

# MOSFET Modules

## HiPerFET and Polar MOSFET Technology

- low  $R_{DSon}$
- fast body diode
- rugged

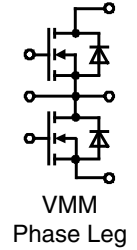
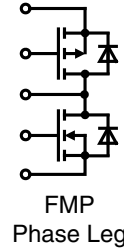
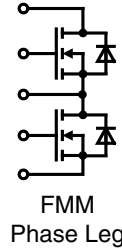
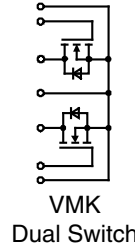
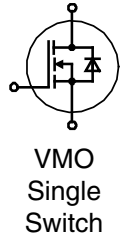

Suffix „F“ = HiPerFET™ Technology with Fast Intrinsic Diode

Part Type	$V_{DSS}$	$I_{D25}$ $T_C = 25^\circ C$	$I_{D80}$ $T_C = 80^\circ C$	$R_{DSon}$ typ. $T_J = 25^\circ C$	$t_r$	$t_f$	$R_{thJC}$	NTC	Fig. No.	Package style Outline drawings on pages O-30...O-55	
○ Not for new design											
➤ New	V	A	A	mΩ	ns	ns	K/W				
<b>Single Switch Modules</b>											
○ VMO 550-01F	100	590	contact factory						X128d	X024a <b>ISOPLUS i4-PAC™</b> 	
○ VMO 650-01F		690							X128d		
○ VMO 1200-01F		1245	930	1.35	200	500	0.039		X130d		
○ VMO 580-02F	200	580	contact factory							X130d	
○ VMO 60-05F	500	60	contact factory							X125f	
<b>Dual Switch Modules – Common Source Configuration</b>											
○ VMK 90-02T2	200	84	contact factory							X125a	X125a <b>TO-240AA</b> 
<b>MOSFET Modules – Phase Leg Configuration</b>											
FMM 75-01F	100	75	50 / 90°C	21	60	60	0.50		X024a	X125f <b>TO-240AA</b> 	
○ VMM 650-01F		680	contact factory						•	X130e	X125g <b>TO-240AA</b> 
➤ FMP 36-015P ①	±150	-22 / 36	*	110 / 40	31	15	1.0 / 1.0		X024a		
➤ FMP 26-02P ①	±200	-17 / 26	*	170 / 60	33	21	1.0 / 1.0		X024a		
○ VMM 45-02F		45	contact factory							X125g	
○ VMM 300-03F	300	290	contact factory							X128a	
➤ FMM 22-05PF	500	13	-	270	25	21	0.95		X024a		
➤ FMM 22-06PF	600	12	-	350	20	23	0.95		X024a		
○ VMM 90-09F	900	85	65	76	140	180	0.08	•	X130e	X125g <b>TO-240AA</b> 	
➤ VMM 90-09P	900	94	70	62	*	*	0.08	•	X130e		

① high side switch: p-channel; low side switch: n-channel \* in progress



# MOSFET Modules

## CoolMOS™ MOSFET Technology

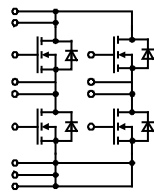

VKM  
H-Bridge

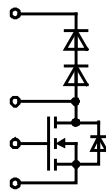

FMD  
Boost

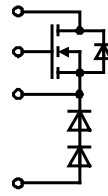

FDM  
Buck

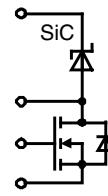

MKE...R..DCG..  
SiC boost

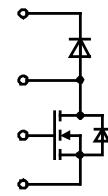

MPA...R...  
boost

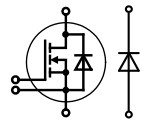

MKE...RK...  
buck/boost

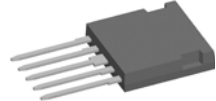
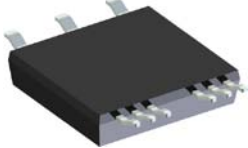
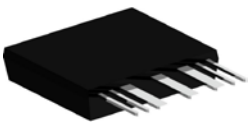
Part Type ○ Not for new design ◇ Under development ➤ New	V <sub>DSS</sub> V	I <sub>D25</sub> T <sub>C</sub> = 25°C A	I <sub>D80</sub> T <sub>C</sub> = 90°C A	R <sub>DSon</sub> typ. T <sub>J</sub> = 25°C mΩ	t <sub>r</sub> ns	t <sub>f</sub> ns	R <sub>thJC</sub> K/W	Fig. No.	Package style Outline drawings on pages O-30...O-55
<b>MOSFET Modules – H Bridge Configuration</b>									
VKM 40-06P1*	600	38		70	10	95	0.45	X102	
<b>MOSFET Modules – Boost Configuration</b>									
○ FMD 21-05QC	500	21	15	180	16	30	1.50	X024a	X024a <b>ISOPLUS i4-PAC™</b> 
FMD 40-06KC *	600	38	25	60	30	10	0.45	X030a	X030a <b>SMPD-B</b> 
FMD 15-06KC5 *		15	11	150	5	5	1.10		
FMD 47-06KC5 *		47	32	40	20	10	0.45		
➤ MPA 22R600DHGFC		17	13	220	in progress		0.70		
➤ MKE 11R600DCGFC <sup>1)</sup>		15	11	150	6	4	1.10		
MKE 38RK600DFELB		50	38 / 80°C	40	20	10	0.45	X030a	
◇ MKG 40RK600LB		52	40	37	in progress				
◇ MKG 40RK600DCGLB <sup>1)</sup>		52	40	37	in progress				
◇ MCB 21RK1200DCGLC <sup>1)</sup>	1200	30	21	80	in progress			X030b	X030b <b>SMPD-B</b> 
<b>MOSFET Modules – Buck Configuration</b>									
FDM 15-06KC5 *	600	15	11	150	5	5	1.10	X024a	
FDM 47-06KC5 *		47	32	40	20	10	0.45		

<sup>1)</sup> with SiC Boost Diode

\* CoolMOS™ is a trademark of Infineon Technologies

X102 **ECO-PAC2**



## Module with HiPerFET™ H-Bridge and Single Phase Mains Rectifier Bridge

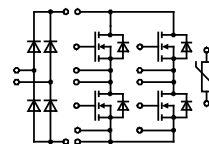

X104 **V2-Pack**

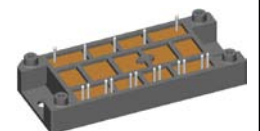

Type ➤ New	V <sub>DSS</sub> V	I <sub>D</sub> T <sub>C</sub> = 25°C A	I <sub>D</sub> T <sub>C</sub> = 80°C A	R <sub>DSon, max</sub> T <sub>C</sub> = 25°C mΩ	V <sub>DRM</sub> Rectifier V	I <sub>DAVM</sub> A	@ T <sub>C</sub> °C	Fig. No.
VBH 40-05B	500	40	30	116	1200	33	80	X104

# Rectifier Bridges for Power Factor Correction

## Power Stage for Boost Converters (Power Factor Correction)

### 1-phase PFC

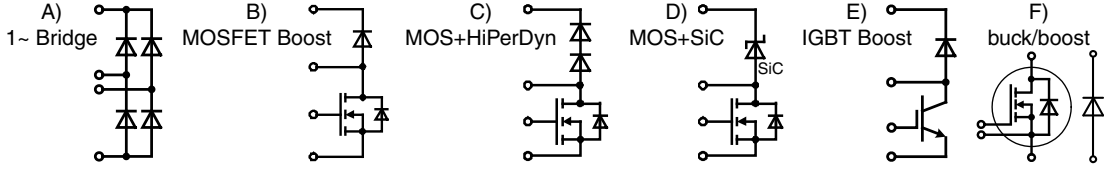

Type	Circuit	V <sub>DSS</sub> max	I <sub>D</sub> T <sub>C</sub> = 25°C	R <sub>DS(on)</sub> max	V <sub>RRM</sub> Boost Diode	V <sub>RRM</sub> Rectifier	Fig. No.	Package style
○ Not for new design ◇ Under development ➤ New		V	A	Ω	V	V		Outline drawings on pages O-30...O-55
<b>MOSFET</b>								
○ FMD 21-05QC	C	500	21	0.220	600	-	X024a	X024a <b>ISOPLUS i4-PAC</b> 
➤ MPA 22R600DHGFC	B	600	17	0.240	-	-		
MKE 11R600DCGFC	D, CoolMOS™	-	15	0.165	-	-		
FMD 15-06KC5	C, CoolMOS™	-	15	0.165	-	-		
MKE 38RK600DFELB	B, CoolMOS™	-	50	0,045	-	-	X030a	
◇ MKG 40RK600LB	F, CoolMOS™ C6	-	52	0,037	-	-		
◇ MKG 40RK600DCGLB	F, CoolMOS™ C6 + SiC	-	52	0,037	-	-		
◇ MCB 21RK1200DCGLC	F, SiC MOSFET/diode	1200	30	0,080	1200	-	X030b	
FMD 40-06KC	C, CoolMOS™	600	38	0.070	600	-	X024a	
FMD 47-06KC5	C, CoolMOS™	-	47	0.045	-	-		
○ VUM 24-05N	A + B	500	35	0.120	600	800	X105b	X030a <b>SMPD-B</b> 
○ VUM 33-05N		500	47					
➤ VUM 33-06PH		600	50					

Type	Circuit	V <sub>CES</sub> max	I <sub>C</sub> T <sub>C</sub> = 25°C	V <sub>CEsat</sub> @ I <sub>C</sub>		V <sub>RRM</sub> Rectifier	Fig. No.
		V	A	V	A	V	
<b>IGBT</b>							
FID 60-06D	E	600	65	1.6	30	-	X024a

Type	Circuit	V <sub>RRM</sub> V	I <sub>DAV</sub> A	@ T <sub>C</sub> °C	Fig. No.
<b>Rectifier</b>					
FBO 16-12N *	A	1200	22	90	X024a
FBO 40-12N *			40	90	
DLA 100B1200LB **			124	80	X030a

\* Recommended in combination with FMD and FID  
\*\* Recommended in combination with MKE and MKG

CoolMOS™ is a trademark of Infineon Technologies

### 3-phase PFC

#### “Vienna Rectifier” circuit

- wide input voltage range
- sinusoidal mains input currents in phase with mains
- boost converter operation:
  - input: 3~ AC mains without neutral conductor
  - output: stabilized DC link with center point
- one module used per phase

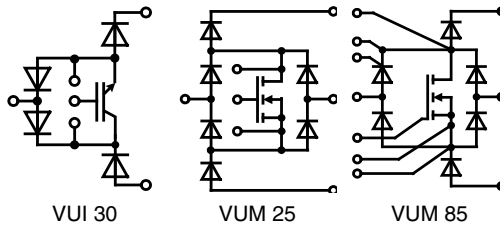

X104 **V2-Pack**



Type	PN / kW	Configuration	Fig. No.
	3 ~ 400V, T <sub>C</sub> = 80°C		
VUM 25-05E ①	10	Vienna rectifier current	X103
VUM 85-05A ①	30	Vienna rectifier current	X104
VUI 30-12N1 ①	15	IGBT stage for buck @ boost PWM converter	X103

X105b **V1-B-Pack**

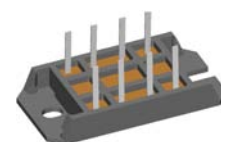

① contact factory

## Diodes for High Switching Frequencies

### Fast Recovery Epitaxial Diodes (HiPerFRED, FRED) and FRD (SONIC)

Power switches (IGBT, MOSFET, BJT, GTO) for applications in electronics are only as good as their associated free-wheeling diodes. At increasing switching frequencies, the proper functioning and efficiency of the power switch, aside from conduction losses, is determined by the turn-off behavior of the diode (characterized by  $Q_r$ ,  $I_{RM}$  and  $t_{rr}$  - Fig. 1). With optimized ultra-fast switching diodes, the development engineer has various possibilities: either higher pulse rate or higher current load or smaller heatsink or more conservative operation due to „cooler“ chips.

The reverse current characteristic following the peak reverse current  $I_{RM}$  is another very important property. The slope of the decaying reverse current  $di_r/dt$  results from design parameters (technology and diffusion of the diode chips). In a circuit this current slope, in conjunction with parasitic inductances (e.g. connecting leads), causes over-voltage spikes and high frequency in-

terference voltages. The higher the  $di_r/dt$  („hard recovery“ or „snap-off“ behavior) the higher is the resulting additional stress for both the diode and the paralleled switch. A slow decay of the reverse current („soft recovery“ behavior), is the most desirable characteristic, and this is designed into all diodes. The wide range of available blocking voltages makes it possible to apply these diodes as output rectifiers in switch-mode power supplies (SMPS) as well as protective and free-wheeling diodes for power switches in inverters.

## Diodes for General Purpose Applications

### Rectifier Diodes

Diodes of the DS-series (anode on stud) and of the DSI-series (cathode on stud) are mainly used for rectifying 50 or 60 Hz mains currents. Discrete diodes in plastic and metal housings and also different diode bridges are available for standard line voltages (from 110 V to 690 V AC).

### Avalanche Diodes

Avalanche diodes or surge-voltage-proof rectifier diodes of the series DSA (anode on stud) and DSAI (cathode on stud) differ from standard diodes of the series DS and DSI in the following manner: the operation in avalanche breakdown above the normal reverse blocking voltage ( $V_{RRM}$ ) can be tolerated as long as the power is within the specified maximum permissible non-repetitive reverse surge dissipation  $P_{RSM}$  at the specified pulse width. In order to have technologically good control of the avalanche breakdown, it is important to ensure homogeneous doping of the middle zone of the silicon chip and suitable junction termination and passivation at the edges where PN-junctions are exposed to the surface (high field strength at the edge). Because of this ruggedness against periodically occurring short-term voltage surges in the blocking direction, the user frequently can do without protective overvoltage networks. In addition, if avalanche diodes are put in series for high voltage applications, the sharp avalanche breakdown of the blocking characteristic ensures static and dynamic voltage distribution uniformly across each device. Thus, in general, none of the series diodes will be overstressed by reverse voltages which are substantially above the avalanche voltage. All high voltage rectifier modules manufactured in quantity are assembled with avalanche diodes.

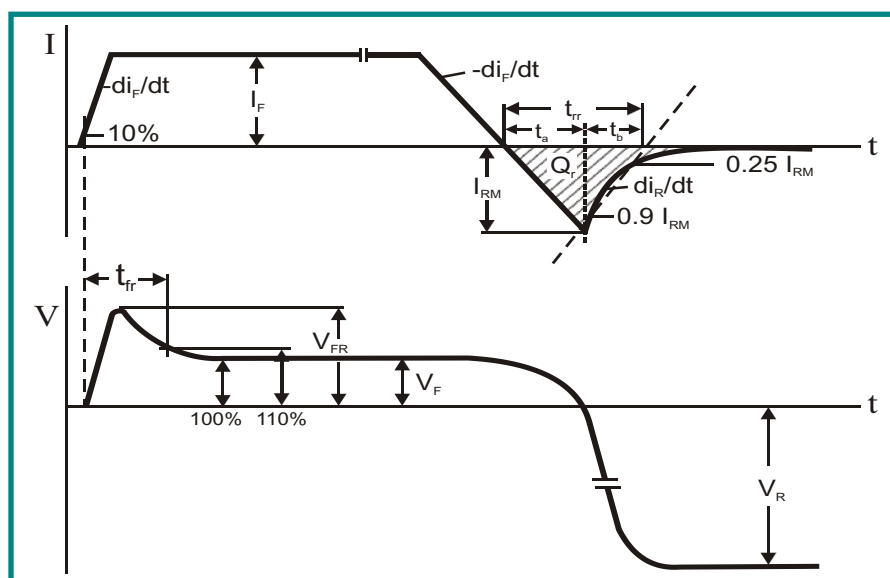
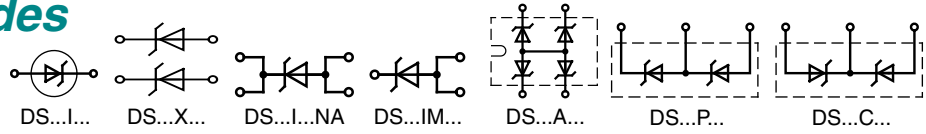

Fig. 1: Current and voltage during turn-on and turn-off switching of fast diodes

# Schottky Gen<sup>2</sup> Diodes

$I_{FAV} = 10 - 300 \text{ A}$



Type	$V_{RRM}$	$I_{FAV}$	@ $T_C$	$V_F$	@ $I_F$	$T_{VJM}$	$R_{thJC}$	Fig. No.	Package style Outline drawings on pages O-30...O-55
➤ New	V	A	°C	V	A	°C	K/W		
<b>DSB 20I15PA</b> <b>DSB 40C15PB</b>	15	20 2x 20	130 130	0.39 0.39	20 20	150 150	1.75 1.75	X005b X005a	X005a <b>TO-220AB</b> 
<b>DSB 30C30PB</b> <b>DSB 60C30PB</b> <b>DSB 60C30HB</b>	30	2x 15 2x 30 2x 30	130 130 125	0.44 0.49 0.47	15 30 30	150 150 150	1.75 0.85 0.95	X005a X005a X014a	X005a <b>TO-220AC</b> 
<b>DSB 10I45PM</b> <b>DSA 20C45PB</b> <b>DSA 15I45PA</b> <b>DSA 15IM45IB</b> <b>DSB 15IM45IB</b> <b>DSA 30C45PB</b>	45	10 2x 10 15 15 15 2x 15	115 155 155 155 125 155	0.52 0.62 0.63 0.63 0.55 0.63	10 10 15 15 15 15	150 175 175 175 150 175	4.50 2.40 1.75 1.75 1.75 1.75	X007b X005a X005b X008a X008a X005a	X005b <b>TO-220ABFP</b> 
➤ <b>DSA 30C45PC</b> <b>DSB 30C45PB</b> <b>DSA 30C45HB</b> <b>DSB 30C45HB</b> <b>DSA 60C45PB</b> <b>DSB 60C45PB</b> <b>DSA 60C45HB</b> <b>DSB 60C45HB</b> <b>DSA 80C45HB</b> <b>DSB 80C45HB</b> <b>DSA 300I45NA</b>		2x 15 2x 15 2x 15 2x 15 2x 30 2x 30 2x 30 2x 30 2x 40 2x 40 300	155 125 155 125 150 125 150 125 150 120 95	0.63 0.55 0.62 0.54 0.67 0.60 0.66 0.58 0.69 0.59 0.70	15 15 15 15 30 30 30 30 40 40 300	175 150 175 150 175 150 175 150 175 150 150	1.75 1.75 1.75 1.75 0.85 0.85 0.95 0.95 0.70 0.70 0.20	X011b X005a X014a X014a X005a X005a X014a X014a X014a X014a X027a	X007a <b>TO-220ACFP</b> 
➤ <b>DSB 10P60PN</b> <b>DSA 20C60PN</b> <b>DSB 20C60PN</b> <b>DSA 30C60PB</b> <b>DSB 30C60PB</b> <b>DSA 60C60PB</b> <b>DSB 60C60PB</b> <b>DSA 60C60HB</b> <b>DSB 60C60HB</b>	2x 60 60	10 2x 10 2x 10 2x 15 2x 15 2x 30 2x 30 2x 30 2x 30 2x 30	110 140 110 150 125 150 125 150 125 125	0.62 0.70 0.62 0.72 0.64 0.77 0.69 0.75 0.67	10 10 10 15 15 30 30 30 30 30	150 175 150 175 150 175 150 175 150 150	4.50 4.50 4.50 1.75 1.75 0.85 0.85 0.95 0.95	X007a X007a X007a X005a X005a X005a X005a X014a X014a	X007a <b>TO-247AD</b> 
<b>DSA 10I100PM</b> <b>DSA 20C100PB</b> <b>DSA 20C100PN</b> <b>DSA 30C100PB</b> <b>DSA 30C100PN</b> <b>DSA 30C100HB</b> <b>DSA 30C100QB</b> <b>DSA 50C100HB</b> <b>DSA 50C100QB</b> <b>DSA 30I100PA</b> <b>DSA 60C100PB</b> <b>DSA 70C100HB</b> <b>DSA 80C100PB</b>	100	10 2x 10 2x 10 2x 15 2x 15 2x 15 2x 15 2x 25 2x 25 30 2x 30 2x 35 2x 40	135 155 135 150 120 150 150 155 155 150 150 150 150	0.71 0.71 0.71 0.73 0.73 0.72 0.72 0.72 0.72 0.78 0.78 0.74 0.80	10 10 10 15 15 15 15 25 25 30 30 35 40	175 175 175 175 175 175 175 175 175 175 175 175 175	4.50 2.40 4.50 1.75 4.25 1.75 1.75 0.95 0.95 0.85 0.85 0.70 0.60	X007b X005a X007a X005a X007a X014a X017a X014a X017a X005b X005a X014a X005a	X011b <b>TO-263AB</b> 
➤ <b>DSA 320A100NB</b> ① <b>DSA 300I100NA</b>		4x 80 300	85 90	0.77 0.79	80 300	150 150	0.80 0.20	X027b X027a	X017a <b>TO-3P</b> 
									X027a/b <b>SOT-227B miniBLOC</b> 



① Non isolated base plate

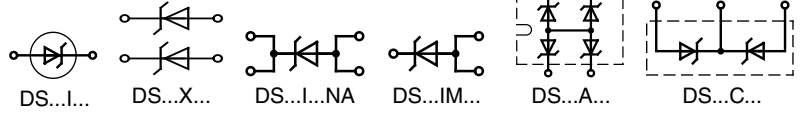

# Schottky Gen<sup>2</sup> Diodes

$I_{FAV} = 5 - 300 \text{ A}$

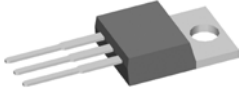
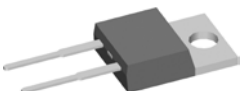
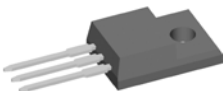

Type	$V_{RRM}$	$I_{FAV}$ d = 0.5	@ $T_C$	$V_F$ $T_{VJ} = 125^\circ\text{C}$	@ $I_F$	$T_{VJM}$	$R_{thJC}$	Fig. No.	Package style Outline drawings on pages O-30...O-55	
➤ New	V	A	°C	V	A	°C	K/W			
DSA 10C150PB	150	2x 5	155	0.71	5	175	4.80	X005a	X004 <b>TO-252AA</b> 	
DSA 20C150PB		2x 10	155	0.73	10	175	2.40	X005a		
DSA 20C150PN		2x 10	135	0.73	10	175	4.50	X007a		
DSA 30C150PB		2x 15	150	0.75	15	175	1.75	X005a		
DSA 30C150HB		2x 15	150	0.74	15	175	1.75	X014a		
DSA 50C150HB		2x 25	155	0.74	25	175	0.95	X014a		
DSA 30I150PA		30	150	0.80	30	175	0.85	X005b		X005a <b>TO-220AB</b> 
DSA 60C150PB		2x 30	150	0.80	30	175	0.85	X005a		
DSA 70C150HB		2x 35	150	0.77	35	175	0.70	X014a		
DSA 120C150QB		2x 60	150	0.80	60	175	0.40	X017a		
DSA 120X150LB		2x 60	150	0.80	60	175	0.80	X030a		
➤ DSA 600A150NB ①	4x 150	115	0.93	150	150	0.30	X027b	X005b <b>TO-220AC</b> 		
DSA 240X150NA	2x 120	95	0.85	120	150	0.40	X027a			
DSA 15IM200UC	200	15	145	0.78	15	175	2.00	X004	X007a <b>TO-220ABFP</b> 	
DSA 30C200IB		2x 15	150	0.78	15	175	1.75	X008a		
DSA 30C200PB		2x 15	150	0.78	15	175	1.75	X005a		
DSA 70C200HB		2x 35	150	0.79	35	175	0.70	X014a		
DSA 90C200HB		2x 45	145	0.86	45	175	0.55	X014a		
DSA 90C200HR		2x 45	140	0.79	45	175	0.70	X016c		
➤ DSA 120X200LB		2x 60	150	0.87	60	175	0.80	X030a		
➤ DSA 240X200LB		2x 120	150	0.87	120	175	0.40	X030a		
DSA 240X200NA		2x 120	90	0.87	120	150	0.40	X027a		X008a <b>TO-262AA (I<sup>2</sup>-PAK)</b> 
DSA 300I200NA		300	80	0.88	300	150	0.20	X027a		

① Non isolated base plate

X017a **TO-3P**

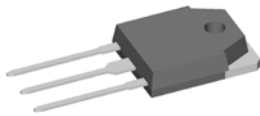

X016c **ISO247**

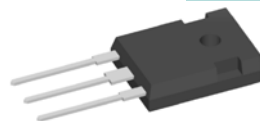

X014a **TO-247AD**

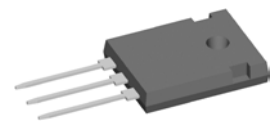

X030a **SMPD-B**



X027a/b **SOT-227B  
miniBLOC**



# Schottky Diodes

$$I_{FAV} = 6 - 2 \times 200 \text{ A}$$

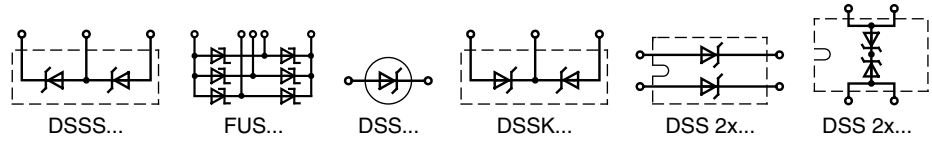

Type	$V_{RRM}$ V	$I_{FAV}$ A d = 0.5	@ $T_C$ °C	$V_F$ V $T_{VJ} = 125^\circ\text{C}$	@ $I_F$ A	$T_{VJM}$ °C	$R_{thJC}$ K/W	Fig. No.	Package style Outline drawings on pages O-30...O-55
DSS 40-0008D DSSK 80-0008D DSS 2x200-0008D ①	8	40 2x 40 2x 200	130 130 90	0.28 0.28 0.28	40 40 100	150 150 150	0.80 0.80 0.40	X014a X014a X027b	X004 <b>TO-252AA</b> 
DSS 20-0015B DSSK 40-0015B DSSK 70-0015B	15	20 2x 20 2x 35	135 135 130	0.33 0.32 0.35	20 20 35	150 150 150	1.40 1.40 1.10	X005b X014a X014a	
DSS 6-0025BS DSS 25-0025B DSSK 18-0025BS DSSK 38-0025B DSSK 38-0025BS DSSK 48-0025B DSSK 50-0025B DSSK 80-0025B	25	6 25 2x 10 2x 20 2x 20 2x 25 2x 25 2x 40	140 125 140 130 130 130 125 130	0.30 0.45 0.37 0.40 0.40 0.35 0.43 0.39	6 25 10 20 20 20 25 40	150 150 150 150 150 150 150 150	3.00 1.40 1.70 1.40 1.40 1.20 1.40 0.80	X004 X005b X011b X005a X011b X005a X014a X014a	X005a <b>TO-220AB</b>  X005b <b>TO-220AC</b> 
DSSK 48-003B DSSK 48-003BS DSSK 70-003B DSSK 80-003B	30	2x 25 2x 25 2x 35 2x 40	130 130 125 130	0.35 0.35 0.39 0.39	20 20 35 40	150 150 150 150	1.20 1.20 1.10 0.80	X005a X011b X014a X014a	
DSS 6-0045AS DSS 10-0045B DSS 16-0045A DSS 16-0045AS DSS 25-0045A DSS 60-0045B DSSK 20-0045B DSSK 28-0045BS DSSK 60-0045A DSSK 60-0045B DSSK 80-0045B DSS 2x61-0045A DSS 2x81-0045B DSS 2x121-0045B DSS 2x160-0045A ① FUS 45-0045B	45	6 10 16 16 25 60 2x 10 2x 15 2x 30 2x 30 2x 40 2x 60 2x 80 2x 120 2x 160 45	165 135 160 160 155 105 135 135 150 125 125 110 85 100 90 90	0.50 0.46 0.56 0.56 0.56 0.57 0.46 0.43 0.58 0.45 0.46 0.65 0.63 0.59 0.72 0.54	6 10 16 16 25 60 10 15 30 30 40 60 80 120 160 15	175 150 175 175 175 150 150 150 175 150 150 150 150 150 150 150	3.00 1.70 1.40 1.40 1.10 0.80 1.70 1.40 1.10 1.10 0.80 0.80 0.80 0.40 0.40 3.10	X004 X005b X005b X011b X005b X014b X005a X011b X014a X014a X014a X027a X027a X027a X027b X024a	X010b <b>ISOPLUS220™</b>  X011b <b>TO-263AB</b>  X014a <b>TO-247AD</b> 
DSS 10-006A DSSK 28-006BS DSSK 40-006B DSSK 80-006B DSSK 80-006BR	60	10 2x 15 2x 20 2x 40 2x 40	160 135 135 120 120	0.65 0.52 0.46 0.51 0.51	10 15 20 40 40	175 150 150 150 150	1.70 1.40 1.10 0.80 0.80	X005b X011b X014a X014a X016a	X014b <b>TO-247AD</b> 
DSSK 40-008B DSSS 35-008AR DSSK 70-008A DSSK 70-008AR DSS 2x111-008A	80	2x 20 2x 80 2x 35 2x 35 2x 110	130 150 150 150 105	0.52 0.68 0.64 0.64 0.72	20 35 35 35 100	150 175 175 175 150	1.10 0.80 0.80 0.80 0.40	X014a X016a X014a X016a X027a	X016a <b>ISOPLUS247™</b> 
DSS 10-01A DSS 10-01AS DSS 16-01A DSS 16-01AS DSS 20-01AC DSSS 30-01AR DSSK 16-01A DSSK 16-01AS DSSK 28-01AS DSSK 30-01A DSSK 50-01A DSS 2x41-01A DSS 2x61-01A DSS 2x160-01A ①	100	10 10 16 16 20 2x 100 2x 8 2x 8 2x 15 2x 15 2x 25 2x 40 2x 60 2x 160	160 160 155 155 140 155 165 165 160 160 155 110 105 80	0.66 0.66 0.65 0.65 0.80 0.63 0.63 0.64 0.63 0.64 0.74 0.74 0.81	10 10 16 16 20 30 8 8 15 15 25 40 60 160	175 175 175 175 175 175 175 175 175 175 175 150 150 150	1.70 1.70 1.40 1.40 1.70 0.80 1.70 1.70 1.40 1.40 1.10 1.10 0.80 0.40	X005b X011b X005b X011b X010b X016a X005a X011b X011b X014a X014a X027a X027a X027b	X024a <b>ISOPLUS i4-PAC™</b>  X027a/b <b>SOT-227B/UI miniBLOC</b> 

① non isolated base plate

# Schottky Diodes

$I_{FAV} = 6 - 2x 100 A$

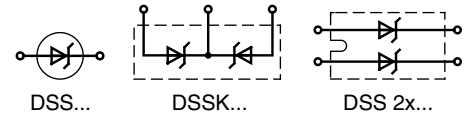

Type	$V_{RRM}$ V	$I_{FAV}$ d = 0.5 A	@ $T_C$ °C	$V_F$ $T_{VJ} = 125^\circ C$ V	@ $I_F$ A	$T_{VJM}$ °C	$R_{thJC}$ K/W	Fig. No.	Package style Outline drawings on pages O-30...O-55
DSS 6-015AS	150	6	160	0.62	6	175	3.00	X004	X004 <b>TO-252AA</b> 
DSSK 20-015A		2x 10	165	0.61	10	175	1.40	X005a	
DSSK 50-015A		2x 25	150	0.68	25	175	1.10	X014a	
DSSK 60-015A		2x 30	155	0.66	30	175	0.80	X014a	
DSSK 60-015AR		2x 30	155	0.66	30	175	0.80	X016a	
DSS 2x101-015A		2x 100	110	0.77	100	150	0.40	X027a	
DSSK 10-018A	180	2x 5	165	0.60	5	175	1.70	X005a	X005a <b>TO-220AB</b> 
DSSK 30-018A		2x 15	150	0.74	15	175	1.70	X014a	
DSSK 60-02A	200	2x 30	155	0.70	30	175	0.80	X014a	
DSSK 60-02AR		2x 30	155	0.70	30	175	0.80	X016a	
DSS 2x101-02A		2x 100	105	0.84	100	150	0.40	X027a	

# Silicon Carbide Schottky Diodes

No reverse recovery

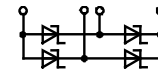

Type	$V_{RRM}$ V	$I_{FAV}$ d = 0.5 A	@ $T_C$ °C	$V_F$ typ., $T_{VJ} = 125^\circ C$ V	@ $I_F$ A	$C_J$ pF	$R_{thJC}$ K/W	Fig. No.
➤ New								
FBS 10-06SC	600	3.0	90	1.70	4.0	9	8.00	X024a
FBS 16-06SC		5.0	90	1.50	6.0	21	5.60	X014a
FBS 10-12SC	1200	4.5	80	2.61	5.0	33	7.00	

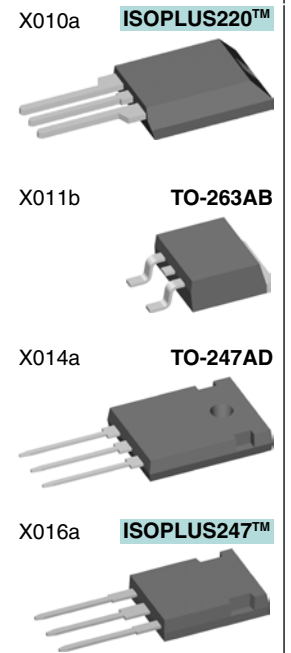

# HiPerDyn™ FRED

Series connected diodes for high switching frequencies; packages isolated ( $2500 V_{RMS}$ )

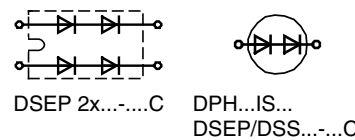

Type	$V_{RRM}$ V	$I_{FAV}$ d = 0.5 A	@ $T_C$ °C	$V_F$ $I_F = I_{FAV}$ V	@ $T_{VJ}$ °C	$t_{rr}$ typ. $T_{VJ} = 25^\circ C$ ns	$I_{RM}$ typ. A	@ -di/dt A/μs	$T_{VJM}$ °C	$R_{thJC}$ K/W	Fig. No.
➤ New											
DSS 17-06CR *	600	17	95	2.71	125	45	2.0	100	175	1.40	X016b
DPH 30IS600HI		30	140	1.89	150	35	3.0	200	175	0.55	
DSEP 15-12CR	1200	15	135	2.67	150	15	10.0	600	175	1.00	X024a
DSEP 30-12CR		30	120	3.18	150	15	5.5	600	175	0.60	
DSEP 2x25-12C	1200	2x 25	90	2.95	150	15	5.5	600	150	0.60	X027a

\* series connected Schottky Diodes

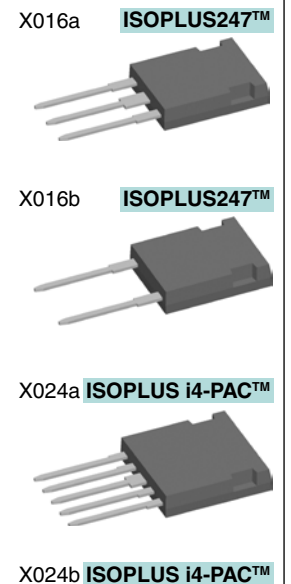

# Dual Ultrafast Diodes

Series connected diodes for high switching frequencies with middle connection; packages isolated ( $2500 V_{RMS}$ )

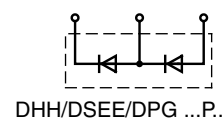

DPG 30P300PJ	2x 300	30	135	0.99	150	35	3.0	200	175	1.05	X010a
DPG 10P400PJ	2x 400	10	145	1.03	150	45	4.0	200	175	2.50	
DSEE 15-12CC	2x 600	15	100	1.50	125	35	4.0	100	175	1.60	X014a
DSEE 29-12CC		30	90	1.75	125	30	4.0	100	175	0.90	
DSEE 30-12A ①		30	90	1.78	125	30	4.0	100	175	0.90	X014a
DSEE 55-24N1F	2x 1200	60	110	1.56	150	75	35	600	175	0.60	X024b
DHH 55-36N1F	2x 1800	60	50	2.06	125	230	60	800	150	0.60	

① Non isolated base plate

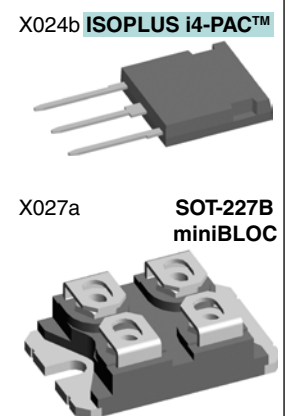

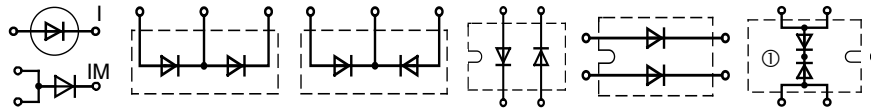

$I_{FAV} = 10 - 2x 200 A$

Type	$V_{RRM}$	$I_{FAV}$	@ $T_C$	$I_{FSM}$	$V_F$	@ $I_F$	$t_{rr}$	$I_{RM}$	$-di/dt$	$T_{VJM}$	$R_{thJC}$	Fig. No.	Package style
➤ New	V	A	d = 0.5 °C	10 ms 45°C A	$T_{VJ} = 150°C$ V	A	ns	typ. $T_{VJ} = 25°C$ A	A/ $\mu$ s	°C	K/W		Outline drawings on pages O-30...O-55
DPG 10I200PA	200	10	145	140	0.98	10	35	3.0	200	175	2.30	X005b	X004 <b>TO-252AA</b>  X007b X005a <b>TO-220AB</b>  X007a X005b <b>TO-220AC</b>  X007a <b>TO-220ABFP</b>  X007b <b>TO-220ACFP</b>  X010a <b>ISOPLUS220™</b>  X011b <b>TO-263AB</b>  X014a <b>TO-247AD</b>  X014b <b>TO-247AD</b>  X016a <b>ISOPLUS247™</b>  X016b <b>ISOPLUS247™</b>  X017a <b>TO-3P</b>  X027a/b <b>SOT-227B/UI miniBLOC</b> 
DPG 10I200PM		10	125	140	0.98	10	35	3.0	200	175	4.40	X007b	
DPG 20C200PB		2x 10	145	140	0.98	10	35	3.0	200	175	2.30	X005a	
DPG 20C200PN		2x 10	125	140	0.98	10	35	3.0	200	175	4.40	X007a	
DPG 15I200PA		15	140	240	1.01	15	35	3.0	200	175	1.70	X005b	
DPG 30C200PB		2x 15	140	240	1.01	15	35	3.0	200	175	1.70	X005a	
DPG 30C200PC		2x 15	140	240	1.01	15	35	3.0	130	175	1.70	X011b	
DPG 30C200HB		2x 15	140	240	1.00	15	35	3.0	200	175	1.70	X014a	
DPF 60C200HB		2x 30	130	400	0.98	30	35	4.0	200	175	0.95	X014a	
DPF 60C200HJ		2x 30	130	560	0.88	30	35	4.0	200	175	1.05	X016a	
DPG 60C200HB		2x 30	135	360	1.06	30	35	3.0	200	175	0.95	X014a	
DPG 60C200QB		2x 30	135	360	1.06	30	35	3.0	200	175	0.95	X017a	
DPF 80C200HB		2x 40	140	560	0.95	40	35	4.0	200	175	0.70	X014a	
➤ DPF 60I200HA		60	135	650	0.98	60	35	4.0	200	175	0.55	X014b	
➤ DPF 120X200NA		2x 60	120	1200	0.90	60	35	4.0	200	175	0.60	X027a	
DPF 240X200NA		2x 120	120	1800	0.90	120	35	4.0	200	175	0.45	X027a	
DPG 10I300PA		300	10	145	140	0.98	10	35	3.0	200	175	2.30	
DPG 10IM300UC	10		150	140	0.98	10	35	3.0	200	175	2.30	X004	
DPG 20C300PB	2x 10		145	140	0.98	10	35	3.0	200	175	2.30	X005a	
DPG 20C300PN	2x 10		125	140	0.98	10	35	3.0	200	175	4.40	X007a	
DPG 15I300PA	15		140	240	1.01	15	35	3.0	200	175	1.70	X005b	
DPG 30C300PB	2x 15		140	240	1.01	15	35	3.0	200	175	1.70	X005a	
DPG 30C300PC	2x 15		140	240	1.01	15	35	3.0	200	175	1.70	X011b	
DPG 30C300HB	2x 15		140	240	1.00	15	35	3.0	200	175	1.70	X014a	
DPF 30I300PA	30		145	390	0.98	30	55	6.0	200	175	0.85	X005b	
DPG 30I300HA	30		135	360	1.06	30	35	3.0	200	175	0.95	X014b	
DPG 30I300PA	30		140	360	1.08	30	35	3.0	200	175	0.85	X005b	
DPG 30IM300PC	30		140	360	1.08	30	35	3.0	200	175	0.85	X011b	
DPG 30P300PJ	2x 300		30	135	450	0.99	30	35	3.0	200	175	1.05	X010a
DPF 60C300HB	2x 30		140	400	0.97	30	55	6.0	200	175	0.95	X014a	
DPG 60C300HB	2x 30		135	360	1.06	30	35	3.0	200	175	0.95	X014a	
DPG 60C300HJ	2x 30		135	450	0.96	30	35	3.0	200	175	1.05	X016a	
DPG 60C300PC	2x 30		140	360	1.08	30	35	3.0	200	175	0.85	X011b	
DPG 60C300QB	2x 30	135	360	1.06	30	35	3.0	200	175	0.95	X017a		
DPG 80C300HB	2x 40	135	450	1.07	40	35	3.0	200	175	0.70	X014a		
DPG 60I300HA	60	125	450	1.10	60	35	3.5	200	175	0.55	X014b		
DPG 60IM300PC	60	135	450	1.14	60	35	3.5	200	175	0.45	X011b		
DPG 120C300QB	2x 60	125	450	1.10	60	35	3.5	200	175	0.55	X017a		
DPG 10I400PA	400	10	145	150	1.03	10	45	4.0	200	175	2.30	X005b	
DPG 10I400PM		10	120	150	1.03	10	45	4.0	200	175	4.40	X007b	
DPG 10P400PJ		2x 400	10	145	130	1.03	10	45	4.0	200	175	2.50	X010a
DPG 20C400PB		2x 10	145	150	1.03	10	45	4.0	200	175	2.30	X005a	
DPG 20C400PC		2x 10	145	150	1.03	10	45	4.0	200	175	2.30	X011b	
DPG 20C400PN		2x 10	120	150	1.03	10	45	4.0	200	175	4.40	X007a	
DPG 15I400PM		15	90	190	1.14	15	45	4.0	200	175	4.20	X007b	
DPG 30C400PB		2x 15	140	190	1.14	15	45	4.0	200	175	1.70	X005a	
DPG 30C400HB		2x 15	140	190	1.13	15	45	4.0	200	175	1.70	X014a	
DPG 30I400HA		30	135	360	1.13	30	45	4.0	200	175	0.95	X014b	
➤ DPF 60XA400NA		2x 30	130	400	1.00	30	60	6.0	200	175	1.15	X027a	
DPG 60C400HB		2x 30	135	360	1.13	30	45	4.0	200	175	0.95	X014a	
DPG 60C400QB		2x 30	135	360	1.13	30	45	4.0	200	175	0.95	X017a	
DPG 80C400HB		2x 40	135	400	1.14	40	45	4.0	200	175	0.70	X014a	
DPG 60I400HA		60	120	450	1.22	60	45	4.0	200	175	0.55	X014b	
DPF 60IM400HB		60	130	600	1.09	60	60	6.0	200	175	0.55	X014a	
DPG 60IM400QB		60	120	450	1.22	60	45	4.0	200	175	0.55	X017a	
➤ DPF 120X400NA	2x 60	120	530	0.95	60	60	6.0	200	175	0.60	X027a		
DPF 240X400NA	2x 120	120	1100	0.95	120	60	6.0	200	175	0.45	X027a		
➤ DPF 400C400NB ①	2x 200	130	1600	0.90	200	60	6.0	200	175	0.20	X027b		
DPH 30IS600HI	600	30	140	450	1.89	30	35	3.0	200	175	0.55	X016b	

① Non isolated base plate

# HiPerFRED™ Diodes

$I_{FAV} = 8 - 2x 120 A$

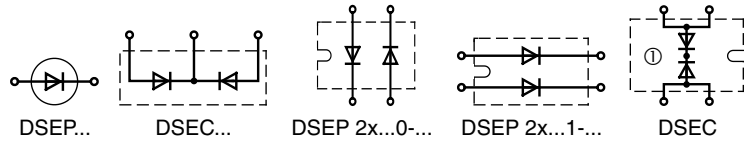

Type	$V_{RRM}$	$I_{FAV}$	$T_C$	$I_{FSM}$	$V_F$	@ $I_F$	$t_{rr}$	$I_{RM}$	$-di/dt$	$T_{VJM}$	$R_{thJC}$	Fig. No.	Package style	
➤ New	V	A	°C	10 ms 45°C	V	A	ns	typ. A	typ. A/μs	°C	K/W		Outline drawings on pages O-30...O-55	
DSEP 40-03AS	300	40	125	340	1.18	40	35	3.5	200	175	0.85	X011b	X004 TO-252AA	
DSEP 6-06AS	600	6	150	40	1.34	6	20	3.5	100	175	2.80	X004	X005a TO-220AB	
DSEP 6-06BS		6	140	40	1.77	6	15	2.0	100	175	2.80	X004		
DSEP 8-06A	1200	10	145	50	1.42	10	35	3.5	100	175	2.50	X005b	X005b TO-220AC	
DSEP 8-06B		10	130	50	1.85	10	30	2.0	100	175	2.50	X005b		
DSEP 15-06A		15	140	110	1.35	15	35	4.0	100	175	1.60	X005b		
➤ DSEP 15-06AS		15	140	110	1.35	15	35	4.0	100	175	1.60	X011b		
DSEP 15-06B		15	130	110	1.59	15	25	2.0	100	175	1.60	X005b		
➤ DSEP 15-06BS		15	130	110	1.59	15	25	2.0	100	175	1.60	X011b		
DSEP 29-06A		30	135	250	1.26	30	35	5.5	100	175	0.90	X005b		
DSEP 29-06AS		30	135	250	1.26	30	35	5.5	100	175	0.90	X011b		
DSEP 29-06B		30	120	250	1.63	30	30	3.0	100	175	0.90	X005b		
DSEP 30-06A		30	135	250	1.25	30	35	5.5	100	175	0.90	X014b		
DSEP 30-06B	30	120	250	1.61	30	30	3.0	100	175	0.90	X014b			
DSEP 30-06BR		30	100	250	1.61	30	30	3.0	100	175	1.10	X016b	X010a ISOPLUS220™	
DSEP 60-06A		60	110	600	1.39	60	35	5.5	100	175	0.65	X014b		
DSEP 60-06AT		60	110	600	1.39	60	35	5.5	100	175	0.65	X019		
DSEP 8-12A	1200	10	130	40	1.96	10	40	4.0	100	175	2.50	X005b	X011b TO-263AB	
DSEP 12-12A		15	130	90	1.87	15	40	4.5	100	175	1.60	X005b		
➤ DSEP 12-12AZ		15	130	90	1.87	15	40	4.5	100	175	1.60	X011c		
DSEP 12-12B		15	130	90	2.06	15	35	3.0	100	175	1.60	X005b		
➤ DSEP 12-12BZ		15	130	90	2.06	15	35	3.0	100	175	1.60	X011c		
DSEP 29-12A		30	120	200	1.81	30	40	8.5	100	175	0.90	X005b		
DSEP 30-12A		30	115	200	1.79	30	40	8.5	100	175	0.90	X014b		
DSEP 30-12AR			30	100	200	1.79	30	40	8.5	100	175	1.10		X016b
DSEP 60-12A			60	85	500	1.81	60	40	7.0	100	175	0.65		X014b
DSEP 60-12AR			60	60	500	1.81	60	40	7.0	100	175	0.80		X016b
DSEC 16-06A	600	2x 10	145	50	1.42	10	35	3.5	100	175	2.50	X005a	X014b TO-247AD	
DSEC 16-06AC		2x 8	85	50	1.20	10	35	3.5	100	175	3.00	X010a		
DSEC 29-06AC		2x 15	140	110	1.34	15	35	4.0	100	175	1.60	X010a	X014b TO-247AD	
DSEC 30-06A		2x 15	140	110	1.34	15	35	4.0	100	175	1.60	X014a		
DSEC 30-06B		2x 15	130	110	1.58	15	25	2.0	100	175	1.60	X014a	X016b ISOPLUS247™	
DSEC 59-06BC		2x 30	105	200	1.56	30	30	4.0	100	175	1.10	X010a		
DSEC 60-06A		2x 30	135	250	1.25	30	35	5.5	100	175	0.90	X014a	X019 TO-268AA	
DSEC 60-06B		2x 30	120	250	1.61	30	30	3.0	100	175	0.90	X014a		
DSEC 16-12A	1200	2x 10	130	40	1.96	10	40	4.0	100	175	2.50	X005a	X020a TO-264	
DSEC 16-12AS		2x 10	130	40	1.96	10	40	4.0	100	175	2.50	X011b		
DSEC 30-12A		2x 15	115	90	1.86	15	40	4.5	100	175	1.60	X014a		
DSEC 60-12A		2x 30	115	200	1.79	30	40	8.5	100	175	0.90	X014a		
DSEC 120-12AK		2x 60	85	500	1.81	60	40	7.0	100	175	0.65	X020a		
DSEP 2x31-03A	300	2x 30	110	300	0.90	30	30	4.5	100	150	1.15	X027a	X020a TO-264	
DSEP 2x61-03A		2x 60	75	600	1.26	60	30	4.0	100	150	0.85	X027a/b		
DSEP 2x91-03A		2x 90	70	1000	1.10	90	30	4.5	100	150	0.60	X027a/b		
DSEP 2x31-06A	600	2x 30	95	250	1.23	30	35	5.5	100	150	1.15	X027a/b	X027a/b SOT-227B/UI miniBLOC	
DSEP 2x31-06B		2x 30	75	250	1.59	30	30	3.0	100	150	1.15	X027a/b		
DSEP 2x61-06A		2x 60	65	600	1.48	60	35	5.5	100	150	0.85	X027a/b		
DSEP 2x91-06A		2x 90	55	1000	1.39	90	35	8.0	100	150	0.60	X027a/b		
DSEP 2x31-12A	1200	2x 30	70	200	1.77	30	40	8.5	100	150	1.15	X027a/b	X027a/b SOT-227B/UI miniBLOC	
DSEP 2x60-12A		2x 60	80	800	1.52	60	40	8.0	100	150	0.60	X027a/b		
DSEP 2x61-12A		2x 60	80	800	1.52	60	40	8.0	100	150	0.60	X027a/b		
DSEP 2x101-04A	400	2x 100	45	1000	1.22	125	30	5.5	100	150	0.60	X027b	X027b	
DSEC 240-04A ①		2x 120	75	2000	1.00	120	30	5.5	100	150	0.45	X027b		
DSEC 240-06A ①	600	2x 120	75	2000	1.26	120	35	8.0	100	150	0.40	X027b		
➤ DPG 60B600LB		60	110	250	0.84	19.6	30	3.0	100	175	1.10	X030a		

① Non isolated base plate

# SONIC-FRD™ Diodes

$I_{FAV} = 5 - 2x 60 A$  • ultrasoft and fast recovery  
• very low temperature dependence

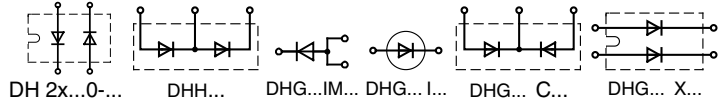

Type	$V_{RRM}$	$I_{FAV}$	@ $T_C$	$I_{FSM}$	$V_F$	@ $I_F$	$t_{rr}$	$I_{RM}$	$-di/dt$	$T_{VJM}$	$R_{thJC}$	Fig. No.	Package style
➤ New	V	A	°C	A	V	A	ns	A	A/ $\mu$ s	°C	K/W		
DHG 5I600PA	600	5	105	40	2.17	5	35	2	100	150	3.15	X005b	
DHG 5I600PM		5	85	40	2.17	5		2	100		4.20	X007b	
DHG 10C600PB		2x 5	105	40	2.17	5		2	100		3.15	X005a	
DHG 10I600PA		10	95	80	2.18	10		4	200		1.80	X005b	
DHG 10I600PM		10	25	80	2.18	10		4	200		4.00	X007b	
DHG 20C600PB		2x 10	95	80	2.18	10		4	200		1.80	X005a	
DHG 20C600QB		2x 10	95	80	2.17	10		4	200		1.80	X017a	
DHG 20I600PA		20	100	150	2.21	20		8	400		0.80	X005b	
DHG 20I600HA		20	95	150	2.19	20		8	400		0.90	X014b	
DHG 40C600PB		2x 20	100	150	2.21	20		8	400		0.80	X005a	
DHG 40C600HB		2x 20	95	150	2.19	20		8	400		0.90	X014a	
DHG 50X600NA		2x 25	70	200	2.03	25		12	600		1.20	X027a	
DHG 30I600PA		30	95	200	2.24	30		12	600		0.60	X005b	
DHG 30IM600PC		30	95	200	2.22	30		12	600		0.60	X011b	
DHG 30I600HA		30	85	200	2.21	30		12	600		0.70	X014b	
DHG 60C600HB		2x 30	85	200	2.21	30		12	600		0.70	X014a	
DHG 100X600NA	2x 50	80	430	2.00	50	20	1200	0.60	X027a				
DHG 60I600HA	60	95	430	2.10	60	24	1200	0.30	X014b	X011b	<b>TO-263AB</b>		
DHG 10I1200PA	1200	10	95	65	2.13	10	75	8	350	150	1.80	X005b	
DHG 10I1200PM		10	30	65	2.13	10		8	350		4.00	X007b	
DHG 20C1200PB		2x 10	95	65	2.13	10		8	350		1.80	X005a	
DHG 20I1200PA		20	105	135	2.16	20		19	750		0.80	X005b	
DHG 20I1200HA		20	95	135	2.14	20		19	750		0.90	X014b	
DHG 40C1200HB		2x 20	95	135	2.14	20		19	750		0.90	X014a	
DHG 50X1200NA		2x 25	70	180	2.00	25		25	1000		1.20	X027a	
DHG 30I1200HA		30	90	180	2.16	30		25	1000		0.70	X014b	
DHG 100X1200NA		2x 50	65	430	2.05	50		50	2500		0.60	X027a	
DHG 60I1200HA		60	95	430	2.22	60		50	2500		0.30	X014b	
DHG 10I1800PA	1800	10	85	65	2.30	10	150	8	200	150	2.15	X005b	
DH 20-18A		20	80	150	2.94	20		16	300		0.90	X014b	
DH 40-18A		40	85	350	2.69	40		33	400		0.45	X014b	
DH 60-14A		60	100	700	2.05	60		60	800		0.30	X014b	
DH 60-16A		60	100	700	2.05	60		60	800		0.30	X014b	
DH 60-18A		60	100	700	2.05	60		60	800		0.30	X014b	
DHG 55-36N1F		2x 1800	60	50	700	2.05		60	60		800	0.60	
DH 2x60-18A	1800	2x 60	55	700	2.02	60	60	800	0.60	X027a			
➤ DH 2x61-16A	1600	2x 60	55	700	2.02	60	60	800	0.60	X027a			
DH 2x61-18A	1800	2x 60	55	700	2.02	60	60	800	0.60	X027a			

X027a **SOT-227B miniBLOC**



X024b **ISOPLUS i4-PAC™**

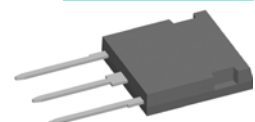

# FRED Diodes

Fast Recovery Epitaxial Diodes



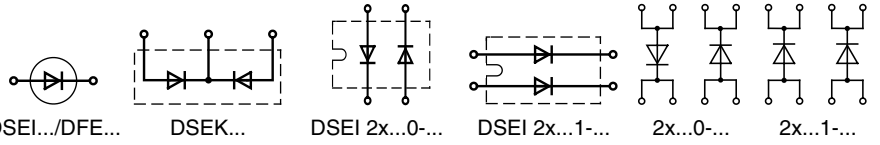



$I_{FAV} = 8 - 2x 165 A$



Type	$V_{RRM}$	$I_{FAV}$		$I_{FRMS}$	$I_{FSM}$	$V_F$		$t_{rr}$	$-di/dt$		$R_{thJC}$	Fig. No.	Package style	
		@ $T_C$				@ $I_F$			typ.					
		d = 0.5			10 ms 45°C	$T_{VJ} = 150°C$		typ.	$T_{VJ} = 100°C$				Outline drawings on pages O-30...O-55	
➤ New	V	A	°C	A	A	V	A	ns	A	A/μs	K/W			
DSEI 8-06A	600	8	115	16	100	1.30	8	35	2.5	64	2.50	X005b	X005b	<b>TO-220AC</b>
DSEI 8-06AS	600	8	115	16	100	1.30	8	35	2.5	64	2.50	X011b		
DFE 10I600PM	600	10	100	16	100	1.30	10	35	2.5	64	4.20	X007b	X007b	<b>TO-220ACFP</b>
DSEI 12-06A	600	14	100	25	100	1.50	16	35	4.0	100	2.00	X005b		
➤ DSEI 12-06AS	600	14	100	25	100	1.50	16	35	4.0	100	2.00	X011b	X005b	
DSEI 12-10A	1000	12	100	25	75	2.10	12	50	6.5	100	1.60	X005b		
DSEI 12-12A	1200	11	100	25	75	2.20	12	50	6.5	100	1.60		X011c	
➤ DSEI 12-12AZ	1200	11	100	25	75	2.20	12	50	6.5	100	1.60	X011c		
DSEI 20-12A	1200	17	85	70	130	1.87	12	40	7.0	100	1.60	X005b	X011b	<b>TO-263AB</b>
DSEI 19-06AS	600	20	65	25	100	1.50	16	35	4.0	100	2.00	X011b		
DSEI 36-06AS	600	37	85	70	300	1.40	37	35	10.0	240	1.00	X011b		
DSEI 30-06A	600	37	85	70	300	1.40	37	35	10.0	240	1.00	X014b	X011c	<b>TO-263AB</b>
DSEI 30-10A	1000	30	85	70	200	2.00	36	35	16.0	240	0.90	X014b		
DSEI 30-10AR	1000	30	85	70	200	2.00	36	35	16.0	240	0.90	X016b		
DSEI 30-12A	1200	26	85	70	200	2.20	30	40	16.0	240	0.90	X014b		
DSEI 60-02A	200	69	85	98	600	0.88	60	35	8.0	200	0.75	X014b	X014a	<b>TO-247AD</b>
DSEI 60-06A	600	60	70	100	550	1.50	70	35	19.0	480	0.75	X014b		
DSEI 60-10A	1000	60	60	100	500	1.80	60	35	32.0	480	0.66	X014b		
DSEI 60-12A	1200	52	60	100	500	2.00	60	40	32.0	480	0.66	X014b		
DSEI 120-06A	600	126	70	100	600	1.12	70	35	17.0	200	0.35	X014b	X014b	<b>TO-247AD</b>
DSEI 120-12A	1200	109	60	100	600	1.55	70	40	25.0	200	0.35	X014b		
DSEK 60-02A	200	2x 34	115	50	325	0.85	30	35	4.0	100	1.00	X014a	X014a	
DSEK 60-02AR	200	2x 34	115	50	325	0.85	30	35	4.0	100	1.00	X016a		
DSEK 60-06A	600	2x 30	85	50	300	1.40	37	35	10.0	240	1.00	X014a	X016a	<b>ISOPLUS247™</b>
DSEK 60-12A	1200	2x 26	85	50	200	2.20	30	40	16.0	240	0.90	X014a		
DSEI 2x30-04C	400	2x 30	85	70	300	1.40	30	35	10.0	240	1.25	X027a	X016a	
DSEI 2x30-06C	600	2x 30	85	70	300	1.40	30	35	10.0	240	1.25	X027a		
DSEI 2x30-10B	1000	2x 30	50	70	200	2.00	30	35	16.0	240	1.25	X027a		
DSEI 2x30-12B	1200	2x 28	50	70	200	2.20	30	40	16.0	240	1.25	X027a		
DSEI 2x31-06P	600	2x 30	85	70	300	1.40	30	35	10.0	240	1.25	X101	X027a	<b>SOT-227B minibLOC</b>
DSEI 2x31-12P	1200	2x 28	50	70	200	2.20	30	40	16.0	240	1.25	X027a		
DSEI 2x31-04C	400	2x 30	85	70	300	1.40	30	35	10.0	240	1.25	X027a		
DSEI 2x31-06C	600	2x 30	85	70	300	1.40	30	35	10.0	240	1.25	X027a		
DSEI 2x31-10B	1000	2x 30	50	70	200	2.00	30	35	16.0	240	1.25	X027a		
DSEI 2x31-12B	1200	2x 28	50	70	200	2.20	30	40	16.0	240	1.25	X027a		
DSEI 2x61-06P	600	2x 60	70	100	550	1.50	60	35	19.0	480	0.70	X101	X101	<b>ECO-PAC 1</b>
DSEI 2x61-12P	1200	2x 52	50	100	450	2.15	60	40	32.0	540	0.70	X101		
DSEI 2x61-02A	200	2x 71	85	100	950	0.88	60	35	8.0	200	0.80	X027a		
➤ DSEI 2x60-04C	400	2x 60	70	100	550	1.50	60	35	19.0	480	0.70	X027a		
DSEI 2x61-04C	400	2x 60	70	100	550	1.50	60	35	19.0	480	0.70	X027a		
DSEI 2x61-06C	600	2x 60	70	100	550	1.50	60	35	19.0	480	0.70	X027a		
DSEI 2x61-10B	1000	2x 60	50	100	500	1.80	60	35	32.0	480	0.70	X027a		
DSEI 2x61-12B	1200	2x 52	50	100	450	2.15	60	40	32.0	480	0.70	X027a		
DSEI 2x121-02A	200	2x 123	70	150	1200	0.95	120	35	12.0	200	0.50	X027a	See data sheet for pin arrangement	
DSEI 2x101-06P	600	2x 96	70	150	1200	1.17	100	40	19.0	200	0.50	X102	X102	<b>ECO-PAC 2</b>
DSEI 2x101-12P	1200	2x 91	50	130	900	1.61	100	40	24.0	200	0.50	X102		
DSEI 2x101-06A	600	2x 96	70	150	1200	1.17	100	35	19.0	200	0.50	X027a		
DSEI 2x101-12A	1200	2x 91	50	130	900	1.61	100	40	24.0	200	0.50	X027a		
DSEI 2x161-02P	200	2x 165	70	270	1200	1.05	200	35	20.0	200	0.29	X102	X102	
DSEI 2x161-06P	600	2x 147	70	270	1200	1.40	200	35	45.0	200	0.29	X102		
DSEI 2x161-12P	1200	2x 128	70	270	1200	1.75	200	40	48.0	200	0.29	X102		

# FRED & HiPerFRED™ Modules

$I_{FAV} = 75 - 582 \text{ A}$

Type	$V_{RRM}$	$I_{FAV}$	@ $T_C$	$I_{FRMS}$	$I_{FSM}$	$V_F$	@ $I_F$	$t_{rr}$	$I_{RM}$	$-di/dt$	$R_{thJC}$	$P_{tot}$	Fig. No.	Package style	
	V	A	°C	A	A	V	A	ns	A	A/ $\mu$ s	K/W	W		Outline drawings on pages O-30...O-55	
<b>FRED</b>															
MEO 550-02DA	200	582	75	822	4800	1.08	520	150	15	200	0.071	1750	X126d	X125e <b>TO-240</b> 	
MEO 500-06DA	600	514	75	726	4800	1.41	520	250	132	800	0.071	1750			
MEO 450-12DA	1200	453	75	640	4800	1.76	520	450	165	800	0.071	1750			
MEK 75-12DA	1200	2x 75	75	107	1200	1.85	100	250	33	200	0.45	280	X125e	X125e <b>TO-240</b> 	
MEA 75-12DA	1200	2x 75													
MEE 75-12DA	2x 1200	75													
MEK 95-06DA	600	2x 95	75	142	1200	1.36	100	250	21	200	0.45	280	X125e	X125e <b>TO-240</b> 	
MEA 95-06DA	600	2x 95													
MEE 95-06DA	2x 600	95													
MEK 250-12DA	1200	2x 260	75	367	2400	1.54	260	450	83	400	0.143	875	X126c	X126c <b>Y4</b> 	
MEA 250-12DA	1200	2x 260													
MEE 250-12DA	2x 1200	260													
MEK 300-06DA	600	2x 304	75	430	2400	1.19	260	250	66	400	0.143	875	X126c	X126c <b>Y4</b> 	
MEA 300-06DA	600	2x 304													
MEE 300-06DA	2x 600	304													
MEK 350-02DA	200	2x 356	75	503	2400	0.92	260	150	15	200	0.143	875	X126d	X126d <b>Y4</b> 	
<b>HiPerFRED™</b>															
MEK 150-04DA	400	2x 150	100	200	1200	1.40*	300	300	11	100	0.35	360	X125e		
MEK 600-04DA	400	2x 575	80	800	3000	1.10	400	220	80	900	0.11	1100	X126c		
MPK 95-06DA	600	2x 95	110	200	1200	1.40	100	35	5.5	100	0.575	215	X125e		

\*  $T_{VJM} = 150^\circ\text{C}$

Diode connections for Fig. X125 (TO-240)

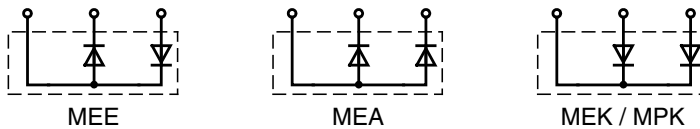

Diode connections for Fig. X126 (Y4: 34 mm package)

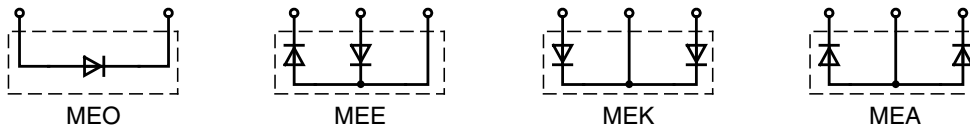

## SemiFast Diodes

$I_{FAV} = 60 \text{ A}$

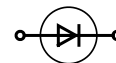

DSDI...

Type	$V_{RRM}$	$I_{FAV}$	@ $T_C$	$I_{FRMS}$	$I_{FSM}$	$V_F$	@ $I_F$	$t_{rr}$	$I_{RM}$	$-di/dt$	$R_{thJC}$	Fig. No.
	V	A	°C	A	A	V	A	ns	A	A/ $\mu$ s	K/W	
DSDI 60-14A	1400	63	60	100	500	4.1	70	300	60	500	0.4	X014b
DSDI 60-16A	1600											
DSDI 60-18A	1800											

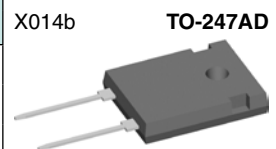



# Rectifier Diodes

$I_{FAV} = 2 - 150 \text{ A}$ ,  
Std. (DS../DL/MA..) & Avalanche (DSA..)

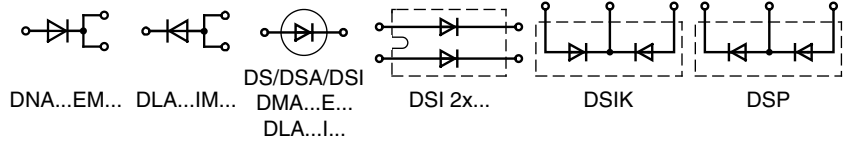

Type	$V_{RRM}$	$I_{FAV}$	@ $T_C$	$P_{RSM}$	$I_{FRMS}$	$I_{FSM}$ 10 ms 45°C	$V_{F0}$	$r_F$	$T_{VJM}$	$R_{thJC}$	$R_{thCH}$	Fig. No.	Package style Outline drawings on pages O-30...O-55
➤ New	V	A	°C	kW	A	A	V	mΩ	°C	K/W	K/W		
DSA 1-12D DSA 1-16D DSA 1-18D	1200 1600 1800	2.3	$T_{amb}$ 45	1.6	7	110	0.80	67.0	150	$R_{thJA}$ 80		X201	X201
DLA 5P800UC	2x 800	5	140	-	10	40	0.74	44.0	175	5.50	0.50	X004	X004
DSP 8-08S DSP 8-12S DSP 8-08A DSP 8-12A DSP 8-08AS DSP 8-12AS	2x 800 2x 1200 2x 800 2x 1200 2x 800 2x 1200	11	100	-	17	100	0.80	40.0	180	3.50	0.60	X011b	X004 TO-252AA
DSP 8-12AC	2x 1200	11	100	-	17	100	0.80	41.0	150	1.80	0.60	X010a	X005a TO-220AB
DSP 25-12A DSP 25-16A DSP 25-12AT DSP 25-16AT	2x 1200 2x 1600 2x 1200 2x 1600	25	135	-	40	300	0.86	13.0	175	0.90	0.25	X014a	X008b TO-262AA (I <sup>2</sup> -PAK)
DSP 25-16AR	2x 1600	28	100	-	43	300	0.80	15.0	180	1.50	0.40	X016a	
DSP 45-12A ➤ DSP 45-12AZ DSP 45-16A ➤ DSP 45-16AZ	2x 1200 2x 1600	45	130	-	70	480	0.85	9.0	175	0.55	0.25	X014a	X005b TO-220AC
DSP 45-16AR	2x 1600	43	100	-	70	480	0.80	11.0	150	0.70	0.20	X016a	
DLA 10IM800UC	800	10	100	-	16	80	0.80	22.0	175	3.15	0.50	X004	
DMA 10I1600PA	1600	10	150	-	25	120	0.82	37.0	175	1.50	0.50	X005b	
➤ DMA 10P1600PZ	1600	10	150	-	25	120	0.82	37.0	175	1.50	0.50	X011c	
DLA 20IM800PC	800	20	100	-	31	200	0.80	19.0	175	1.80	0.25	X011b	X010a ISOPLUS220™
DSI 30-08A DSI 30-12A DSI 30-16A	800 1200 1600	30	125	-	35	300	0.85	13.0	150	1.00	0.50	X005b	
DSI 30-08AS DSI 30-12AS DSI 30-16AS	800 1200 1600	30	100	-	35	300	0.85	13.0	150	1.00	0.50	X011b	X010b ISOPLUS220™
DSI 30-08AC	800	30	95	-	35	200	0.80	15.0	150	1.10	0.60	X010b	
DMA 30E1800HA	1800	30	140	-	70	370	0.88	12.1	175	0.70	0.25	X014b	
DNA 30E2200FE	2200	30	100	-	70	370	0.88	12.2	175	1.35	0.20	X024e	
➤ DNA 30ER2200IY DNA 30E2200PA ➤ DNA 30E2200PZ ➤ DNA 30EM2200PZ	2200	30	140	-	35	370	0.88	12.9	175	0.70	0.50	X008b X005b	X011a TO-263AA
DLA 40IM800PC	800	40	130	-	35	300	0.81	8.0	175	0.80	0.25	X011b	
DSI 45-08A DSI 45-12A DSI 45-16A	800 1200 1600	45	130	-	70	480	0.85	9.0	175	0.55	0.25	X014b	X011b TO-263AB
DSI 45-16AR	1600	48	105	-	70	475	0.80	8.0	150	0.55	0.20	X016b	
DSIK 45-16AR	1600	2x 45	100	-	70	475	0.80	8.0	150	0.65	0.20	X016a	
DSI 2x55-12A DSI 2x55-16A	1200 1600	2x 56	80	-	120	650	0.80	8.0	150	0.65	0.10	X027a	X011c TO-263AB
DLA 60I1200HA	1200	60	150	-	70	850	0.77	4.2	175	0.30	0.25	X014b	
DMA 150E1600NA	1600	150	90	-	150	3000	0.83	2.0	150	0.25	0.10	X027a	

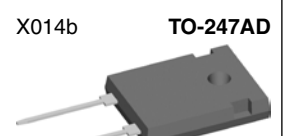
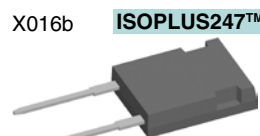
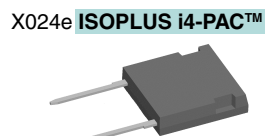
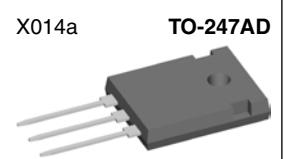
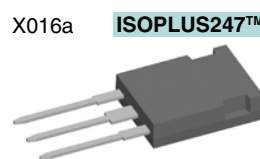
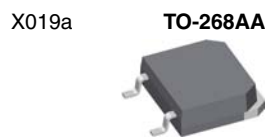
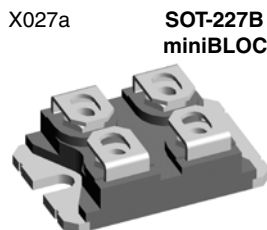

# Rectifier Diodes

$I_{FAV} = 3 - 110 \text{ A}$ , Standard Diodes (DS..), Avalanche Diodes (DSA..)

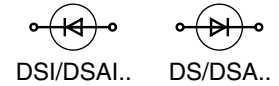

Type	$V_{RRM}$	$I_{FAV}$	@ $T_C$	$P_{RSM}$	$I_{FRMS}$	$I_{FSM}$ 10 ms 45°C	$V_{F0}$	$r_F$	$T_{VJM}$	$R_{thJC}$	$R_{thCH}$	Symbol	Fig. No.	Package style					
➤ New	V	A	°C	kW	A	A	V	mΩ	°C	K/W	K/W			Outline drawings on pages O-30...O-55					
DS 2-08A DS 2-12A	800 1200	3.6	$T_{amb}$ 45	-	7	120	0.85	43.0	180	$R_{thJA}$ 30			X200	X200 <b>Metal-can</b> 					
DSA 2-12A DSA 2-16A DSA 2-18A	1200 1600 1800			2.5	7	120	0.85	43.0	180										
DSA 9-12F DSA 9-16F DSA 9-18F	1200 1600 1800			11	100	4.5	18	250	0.85		15.0				180	2.00	1.00	X204 	X204 <b>DO-203AA (DO-4) M5</b> 
DS 17-08A DS 17-12A	800 1200			25	125	-	40	370	0.85		8.0				180	1.50	0.60		
DSA 17-12A DSA 17-16A DSA 17-18A	1200 1600 1800	25	125																
DSI 17-08A DSI 17-12A	800 1200	25	125	-	40	370	0.85	8.0	180	1.50	0.60	X205 	X205 <b>DO-203AA (DO-4) 10-32 UNF</b> 						
DSAI 17-12A DSAI 17-16A DSAI 17-18A	1200 1600 1800	25	100	7	40	370	0.85	8.0	180	1.50	0.60								
DS 35-08A DS 35-12A	800 1200	49	100	-	80	650	0.85	4.5	180	1.05	0.20			X206a 	X206a <b>DO-203AB (DO-5)</b> 				
DSA 35-12A DSA 35-16A DSA 35-18A	1200 1600 1800	49	100	11	80	650	0.85	4.5	180	1.05	0.20								
DSI 35-08A DSI 35-12A	800 1200	49	100	-	80	650	0.85	4.5	180	1.05	0.20	X206a 	X206a <b>DO-203AB (DO-5)</b> 						
DSAI 35-12A DSAI 35-16A DSAI 35-18A	1200 1600 1800	49	100	11	80	650	0.85	4.5	180	1.05	0.20								
DS 75-08B DS 75-12B	800 1200	110	100	-	160	1400	0.75	2.0	180	0.50	0.40			X207 	X207 <b>DO-203AB (DO-5)</b> 				
DSA 75-12B DSA 75-16B DSA 75-18B	1200 1600 1800	110	100	20	160	1400	0.75	2.0	180	0.50	0.40								
DSI 75-08B DSI 75-12B	800 1200	110	100	-	160	1400	0.75	2.0	180	0.50	0.40	X207 	X207 <b>DO-203AB (DO-5)</b> 						
DSAI 75-12B DSAI 75-16B DSAI 75-18B	1200 1600 1800	110	100	20	160	1400	0.75	2.0	180	0.50	0.40								

X209 **TO-208AC (TO-48)**

# Phase Control Thyristors

$I_{TAV} = 25 - 63 \text{ A}$



Type	$V_{RRM}$ $V_{DRM}$	$I_{TAV}$ $T_C = 85^\circ\text{C}$	$I_{T(RMS)}$	$I_{TSM}$ 45°C 10 ms	$(dv/dt)_{cr}$	$V_{TO}$	$r_T$	$T_{VJM}$	$R_{thJC}$	$R_{thCH}$	Fig. No.
	V	A	A	A	V/μs	V	mΩ	°C	K/W	K/W	
CS 23-08io2 CS 23-12io2 CS 23-16io2	800 1200 1600	25	50	450	1000	1.00	10.0	125	1.00	0.60	X209 
CS 35-08io4 CS 35-12io4 CS 35-14io4	800 1200 1400	63	120	1200	1000	0.85	3.5	125	0.40	0.20	

## Phase Control Thyristors

Thyristors are very rugged devices. Compared to all other controlled semiconductor components, they feature the highest current capacity per chip area especially at high voltage. They are mainly used as control devices in 50 and 60 Hz AC mains equipment. Principal applications are static converter circuits for speed control of DC-drives, or switching and control functions for temperature, lighting, soft-start, etc. in single-phase and three-phase AC switch configurations. Phase control thyristors are designed for optimal forward conduction and reverse blocking characteristics, due to only moderate requirements for turn-on and turn-off parameters.

## Phase Control Thyristors

$I_{TAV} = 5 - 100 \text{ A}$

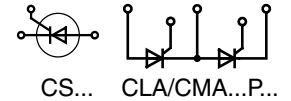

Type	$V_{RRM}$ $V_{DRM}$	$I_{TAV}$	@ $T_C$	$I_{T(RMS)}$	$I_{TSM}$ 45°C 10 ms	$(dv/dt)_{cr}$	$V_{TO}$	$r_T$	$T_{VJM}$	$R_{thJC}$	$R_{thCH}$	Fig. No.	Package style
➤ New	V	A	°C	A	A	V/μs	V	mΩ	°C	K/W	K/W		Outline drawings on pages O-30...O-55
CLA 5E1200UC	1200	5	125	8	50	500	0.90	85.0	150	2.50	0.50	X004	X005a TO-220AB
CNA 10E2500FB	2500	10	100	16	120	2500	0.97	30.0	125	1.50	0.15	X024c	
CS 19-08ho1	800	19	85	29	160	500	0.85	27.0	125	1.00	0.25	X005a	X011b
CS 19-12ho1	1200												
CS 19-08ho1S	800												
CS 19-12ho1S	1200												
CS 20-12io1	1200	19	85	30	200	1000	1.10	40.0	125	0.62	0.20	X014a	X007a TO-220ABFP
CS 20-14io1	1400												
CS 20-16io1	1600												
CS 20-22moF1	2200	18	85	28	200	2500	0.97	17.0	125	0.92	0.15	X024c	
CS 20-25mo1F	2500												
CS 20-25moT1	2500	18	85	28	200	2500	0.97	17.0	125	0.80	0.15	X019	
CS 22-08io1M	800	22	85	35	300	500	0.90	18.0	150	2.50	0.50	X007a	X011b TO-263AB
CS 22-12io1M	1200												
CLA 30E1200PB	1200	30	115	35	300	500	0.86	13.2	150	0.65	0.50	X005a	X011b
CLA 30E1200PC	1200												
CLA 30E1200HB	1200	30	120	70	300	500	0.86	12.5	150	0.55	0.25	X014a	
➤ CLB 30I1200HB *													X011c TO-263AB
CMA 30E1600PB	1600	30	115	50	260	500	0.92	18.0	150	0.75	0.50	X005a	X011c TO-263AB
➤ CMA 30E1600PZ	1600	30	115	50	260	500	0.92	18.0	150	0.75	0.25	X011c	X007a
CMA 30E1600PN	1600	30	40							2.50	0.50	X007a	
CMA 30P1600FC	2x 1600	30	90	47	300	1000	0.90	13.8	150	1.05	0.25	X024a	
CS 30-12io1	1200	31	85	49	300	1000	0.90	15.0	125	0.62	0.20	X014a	X014a TO-247AD
CS 30-14io1	1400												
CS 30-16io1	1600												
CLA 40P1200FC	1200	40	95	63	550	1000	0.86	7.9	150	0.80	0.20	X024a	
CS 45-08io1	800	45	105	70	520	1000	0.90	10.7	140	0.30	0.25	X014a	X015a PLUS247
CS 45-12io1	1200												
CS 45-16io1	1600												
CS 45-16io1R	1600	48	75	75	520	1000	0.85	11.0	140	0.62	0.20	X016a	
CLA 50E1200HB	1200	50	125	70	550	1000	0.88	7.7	150	0.25	0.25	X014a	X016a ISOPLUS247™
CLA 50E1200TC	1200	50	125	70	550	1000	0.88	7.7	150	0.25	0.15	X019	
➤ CMA 50E1600TZ	1600	50	110	70	550	1000	0.83	9.6	150	0.40	0.15	X019a	
CMA 50P1600FC	2x 1600	50	90	79	800	1000	0.92	6.3	150	0.65	0.25	X024a	
CS 60-12io1	1200	48	105	75	1500	1000	0.85	3.7	140	0.32	0.15	X015a	X016a
CS 60-14io1	1400												
CS 60-16io1	1600												
CLA 80E1200HF	1200	80	115	70	900	1000	0.88	6.3	150	0.20	0.25	X015a	
➤ CMA 80E1600HB	1600	80	115	70	720	1000	0.90	6.4	150	0.20	0.25	X014a	

\* Anode gated

X024c ISOPLUS i4-PAC™

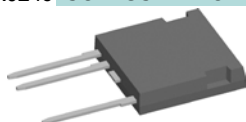

X024a ISOPLUS i4-PAC™

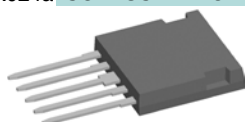

X019a

TO-268AA



X019

TO-268AA



One of the essential advantages of power semiconductor modules compared to discrete designs is the electrical isolation between the baseplate of the module and the parts subject to voltage (3.6 - 4.8 kV<sub>RMS</sub> tested). This makes possible the mount-down of any number of the same or different modules on a common heatsink. It is feasible to use standard housings with appropriate accessories for designing compact power converter operating from AC mains up to 690 V.

## Plastic Housing with DCB Substrate

IXYS has succeeded in simplifying the conventional multilayer module construction by the DCB (Direct Copper Bonding) technique.

Other features are:

- top-side electrical terminals with captured nuts;
- series-connected diode/diode, thyristor/ diode and thyristor/thyristor modules;
- easy assembly.

All thyristor modules with DCB ceramic base contacts are available in volume with two standardized twin

plugs (2.8 mm x 0.8 mm) for gate and auxiliary cathode control terminals (version 1). Modules in TO-240 housing of the version 8 are delivered with gate plugs only (without auxiliary cathode terminal; mounting screws available on request). The module housing is designed for adequate clearance and creepage distance resulting in  recognition by Underwriters Laboratories, Inc., USA for all types.

## New Generation Silicon Chips

All chips are designed by applying separation diffusion processes such that the zones responsible for the surface field strength are located at the upper chip side. This results in the capability of soldering the entire chip area onto the DCB ceramic substrate without a molybdenum strain buffer, which in turn leads to good stability of the chips as well as to large area heat dissipation if a load is applied. All zones at the edges which are decisive for the blocking stability are coated with passivation glasses the coefficient of expansion of which match that of silicon. Silicon chips increasingly use planar technology with guard rings and channel stoppers to reduce electrical surface fields. This chip design supercedes the design of thyristor chips which

were fabricated with passivation masks so that modules of the new series designed with the updated state-of-the-art utilize planar passivated chips processed by separation diffusion techniques. The contact areas of the chips possess physical vapor deposited metal layers. For the user the improved properties are:

- Excellent long-term stability of blocking currents and blocking voltages,
- increased life time of the internal soldered connections,
- high power cycling capability ( $\geq 50\,000$ ).

The thyristor/diode chips have been optimized with regard to their turn-off parameters: decreasing the carrier lifetime results in reduced stored charges QS, which in turn significantly reduces requirements for RC-snubbers for over-voltage protection. Cost reduction and improved efficiency are the benefits of these characteristics. By re-developing the silicon chips, improvements of the firing characteristics were achieved by specifying a higher „gate current not to fire“ IGD resulting in substantially less susceptibility to misfiring. This leads to greater safety of operation and higher reliability of the equipment.

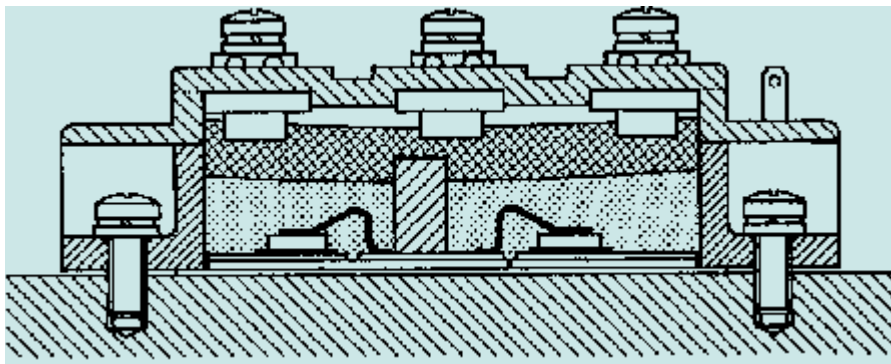
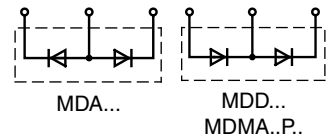



Fig. 1: Principal cross section of an IXYS module with DCB technology

# Diode Modules, Dual

$I_{FAV} = 25 - 224 \text{ A}$



Type	$V_{RRM}$	$I_{FAV}$	$T_C$	$I_{FSM}$ 45°C 10 ms	$V_{F0}$	$r_F$	$T_{VJM}$	$R_{thJC}$	$R_{thCH}$	Fig. No.	Package style Outline drawings on pages O-30...O-55
➤ New	V	A	°C	A	V	mΩ	°C	K/W	K/W		
➤ MDMA 25P1200TG	1200	25	100	320	0.83	11.00	150	1.10	0.20	X125e	 <p>TO-240AA</p>
➤ MDMA 25P1600TG	1600										
MDD 26-08N1B	800	36	100	650	0.80	6.10	150	1.00	0.20		
MDD 26-12N1B	1200										
MDD 26-14N1B	1400										
MDD 26-16N1B	1600										
MDD 26-18N1B	1800										
➤ MDMA 35P1200TG	1200	35	100	500	0.82	7.30	150	0.90	0.20		
➤ MDMA 35P1600TG	1600										
MDD 44-08N1B	800	59	100	1150	0.80	4.30	150	0.59	0.20		
MDD 44-12N1B	1200										
MDD 44-14N1B	1400										
MDD 44-16N1B	1600										
MDD 44-18N1B	1800										
➤ MDMA 50P1200TG	1200	50	100	850	0.82	5.50	150	0.65	0.20		
➤ MDMA 50P1600TG	1600										
MDD 56-08N1B	800	71	100	1400	0.80	3.00	150	0.51	0.20		
MDD 56-12N1B	1200										
MDD 56-14N1B	1400										
MDD 56-16N1B	1600										
MDD 56-18N1B	1800										
➤ MDMA 65P1200TG	1200	65	100	1100	0.81	4.30	150	0.50	0.20		
➤ MDMA 65P1600TG	1600										
MDD 72-08N1B	800	99	100	1700	0.80	2.30	150	0.35	0.20		
MDD 72-12N1B	1200										
MDD 72-14N1B	1400										
MDD 72-16N1B	1600										
MDD 72-18N1B	1800										
➤ MDMA 85P1200TG	1200	85	100	1500	0.80	3.20	150	0.35	0.20		
➤ MDMA 85P1600TG	1600										
MDD 95-08N1B	800	120	105	2800	0.75	1.95	150	0.26	0.20		
MDD 95-12N1B	1200										
MDD 95-14N1B	1400										
MDD 95-16N1B	1600										
MDD 95-18N1B	1800										
MDD 95-20N1B	2000										
MDD 95-22N1B	2200										
MDA 95-22N1B	2200										
➤ MDMA 110P1200TG	1200	110	100	1900	0.79	2.80	150	0.30	0.20		
➤ MDMA 110P1600TG	1600										
➤ MDMA 140P1200TG	1200	140	100	2800	0.78	2.20	150	0.23	0.20	X126c	 <p>Y4</p>
➤ MDMA 140P1600TG	1600										
➤ MDMA 140P1800TG	1800										
➤ MDMA 140P2200TG	2200										
MDD 142-08N1	800	165	100	4700	0.80	1.30	150	0.21	0.10		
MDD 142-12N1	1200										
MDD 142-14N1	1400										
MDD 142-16N1	1600										
MDD 142-18N1	1800										
MDD 172-08N1	800	190	100	6600	0.80	0.80	150	0.21	0.10		
MDD 172-12N1	1200										
MDD 172-14N1	1400										
MDD 172-16N1	1600										
MDD 172-18N1	1800										
MDD 200-14N1	1400	224	100	10500	0.80	0.60	150	0.13	0.10		
MDD 200-16N1	1600										
MDD 200-18N1	1800										
MDD 200-22N1	2200										

# Diode Modules, Single and Dual

$I_{FAV} = 175 - 700 \text{ A}$

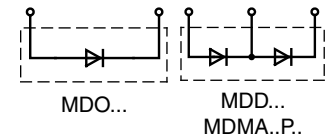

Type	$V_{RRM}$	$I_{FAV}$	$T_C$	$I_{FSM}$ 45°C 10 ms	$V_{F0}$	$r_F$	$T_{VJM}$	$R_{thJC}$	$R_{thCH}$	Fig. No.	Package style
➤ New	V	A	°C	A	V	mΩ	°C	K/W	K/W		Outline drawings on pages O-30...O-55
MDD 175-28N1	2800	175	100	4500	0.90	1.80	150	0.140	0.07	X131c	X129c Y2
MDD 175-34N1	3400										
➤ MDMA 200P1600SA	1600	200	85	6000	0.96	1.38	150	0.140	0.075	X141c	X129c Y2
MDD 220-08N1	800	270	100	8500	0.75	0.90	150	0.129	0.04	X129c	
MDD 220-12N1	1200										
MDD 220-14N1	1400										
MDD 220-16N1	1600										
MDD 220-18N1	1800										
MDD 250-08N1	800	290	100	11000	0.75	0.75	150	0.129	0.04		X131c Y1
MDD 250-12N1	1200										
MDD 250-14N1	1400										
MDD 250-16N1	1600										
MDD 255-12N1	1200	270	100	9500	0.80	0.60	150	0.140	0.04	X131c	X132b Y1
MDD 255-14N1	1400										
MDD 255-16N1	1600										
MDD 255-18N1	1800										
MDD 255-20N1	2000										
MDD 255-22N1	2200										
MDD 310-08N1	800	305	100	11500	0.75	0.63	150	0.129	0.04	X129c	X129c Y1
MDD 310-12N1	1200										
MDD 310-14N1	1400										
MDD 310-16N1	1600										
MDD 310-18N1	1800										
MDD 310-20N1	2000										
MDD 310-22N1	2200										
MDD 312-12N1	1200	310	100	10500	0.80	0.60	150	0.120	0.04	X131c	X141c SimBus A
MDD 312-14N1	1400										
MDD 312-16N1	1600										
MDD 312-18N1	1800										
MDD 312-20N1	2000										
MDD 312-22N1	2200										
➤ MDMA 380P1600KC	1600	380	100	11000	0.75	0.53	140	0.110	0.04		X142c ComPack
MDO 500-12N1	1200	560	85	15000	0.80	0.38	140	0.072	0.02	X132b	
MDO 500-14N1	1400										
MDO 500-16N1	1600										
MDO 500-18N1	1800										
MDO 500-20N1	2000										
MDO 500-22N1	2200										
MDO 600-16N1	1600	608	85	15000	0.80	0.38	140	0.072	0.02		X142c ComPack
MDMA 700P1600CC	1600	700	100	20000	0.76	0.32	150	0.060	0.02	X142c	

For more single and dual diode modules with higher current, please see pages 139 and 140.

# Thyristor / Diode Modules

$I_{TAV} = 25 - 85 \text{ A}$

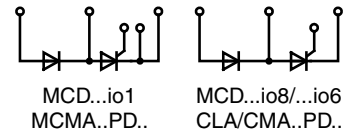

Type	$V_{RRM}$ $V_{DRM}$	$I_{TAV}$	$T_C$	$I_{T(RMS)}$	$I_{TSM}$ 45°C 10 ms	$V_{TO}$	$r_T$	$T_{VJM}$	$R_{thJC}$	$R_{thCH}$	Fig. No.	Package style
➤ New	V	A	°C	A	A	V	mΩ	°C	K/W	K/W		Outline drawings on pages O-30...O-55
➤ MCMA 25PD1200TB	1200	25	82	40	400	0.87	13.0	140	1.20	0.2	X125b	 <p><b>SOT-227B miniBLOC</b></p>
➤ MCMA 25PD1600TB	1600											
MCD 26-08io1B	800	27	85	50	520	0.85	11.0	125	0.88	0.2		
MCD 26-12io1B	1200											
MCD 26-14io1B	1400											
MCD 26-16io1B	1600											
MCD 26-08io8B	800	27	85	50	520	0.85	11.0	125	0.88	0.2	X125d	
MCD 26-12io8B	1200											
MCD 26-14io8B	1400											
MCD 26-16io8B	1600											
➤ MCMA 35PD1200TB	1200	35	85	55	520	0.87	9.8	140	0.90	0.2	X125b	
➤ MCMA 35PD1600TB	1600											
MCD 40-12io6	1200	38	85	60	500	0.85	9.5	125	0.60	0.1	X027a	
MCD 40-16io6	1600											
MCD 44-08io1B	800	49	85	80	1150	0.85	5.3	125	0.53	0.2	X125b	
MCD 44-12io1B	1200											
MCD 44-14io1B	1400											
MCD 44-16io1B	1200											
MCD 44-18io1B	1600											
MCD 44-08io8B	800	49	85	80	1150	0.85	5.3	125	0.53	0.2	X125d	
MCD 44-12io8B	1200											
MCD 44-14io8B	1400											
MCD 44-16io8B	1600											
MCD 44-18io8B	1800											
➤ MCMA 50PD1200TB	1200	50	85	79	800	0.89	5.3	140	0.70	0.2	X125b	
➤ MCMA 50PD1600TB	1600											
CLA 60PD1200NA	1200	60	100	94	1100	0.79	4.8	150	0.55	0.1	X027a	
MCD 56-08io1B	800	60	85	100	1500	0.85	3.7	125	0.45	0.2	X125b	
MCD 56-12io1B	1200											
MCD 56-14io1B	1400											
MCD 56-16io1B	1600											
MCD 56-18io1B	1800											
MCD 56-08io8B	800	60	85	100	1500	0.85	3.7	125	0.45	0.2	X125d	
MCD 56-12io8B	1200											
MCD 56-14io8B	1400											
MCD 56-16io8B	1600											
MCD 56-18io8B	1800											
➤ MCMA 65PD1200TB	1200	65	85	105	1150	0.85	4.8	140	0.50	0.2	X125b	
➤ MCMA 65PD1600TB	1600											
CMA 80PD1600NA	1600	80	80	126	1150	0.86	5.5	150	0.45	0.1	X027a	
MCD 72-08io1B	800	85	85	180	1700	0.85	3.2	125	0.30	0.2	X125b	
MCD 72-12io1B	1200											
MCD 72-14io1B	1400											
MCD 72-16io1B	1600											
MCD 72-18io1B	1800											

# Thyristor / Diode Modules

$I_{TAV} = 85 - 250 \text{ A}$

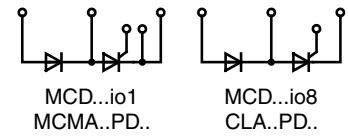

Type	$V_{RRM}$ $V_{DRM}$	$I_{TAV}$	$T_C$	$I_{T(RMS)}$	$I_{TSM}$ 45°C 10 ms	$V_{TO}$	$r_T$	$T_{VJM}$	$R_{thJC}$	$R_{thCH}$	Fig. No.	Package style Outline drawings on pages O-30...O-55
➤ New	V	A	°C	A	A	V	mΩ	°C	K/W	K/W		
MCD 72-08io8B	800	85	85	180	1700	0.85	3.20	125	0.300	0.200	X125d	X027a <b>SOT-227B miniBLOC</b> 
MCD 72-12io8B	1200											
MCD 72-14io8B	1400											
MCD 72-16io8B	1600											
MCD 72-18io8B	1800											
➤ MCMA 85PD1200TB	1200	85	85	1500	135	0.85	3.90	140	0.380	0.200	X125b	X027a
➤ MCMA 85PD1600TB	1600											
CLA 100PD1200NA	1200	100	85	150	1500	0.83	3.70	150	0.350	0.100	X027a	
MCD 94-20io1B	2000	104	85	180	1700	0.85	3.20	125	0.220	0.200	X125b	X125b <b>TO-240AA</b> 
MCD 94-22io1B	2200											
MCD 95-08io1B	800	116	85	180	2250	0.8	2.40	125	0.220	0.200		
MCD 95-12io1B	1200											
MCD 95-14io1B	1400											
MCD 95-16io1B	1600											
MCD 95-18io1B	1800											
MCD 95-08io8B	800	116	85	180	2250	0.8	2.40	125	0.220	0.200	X125d	X125d <b>TO-240</b> 
MCD 95-12io8B	1200											
MCD 95-14io8B	1400											
MCD 95-16io8B	1600											
MCD 95-18io8B	1800											
➤ MCMA 110PD1200TB	1200	110	85	170	1900	0.85	3.30	140	0.300	0.200	X125b	X125b
➤ MCMA 110PD1600TB	1600											
➤ MCNA 120PD2200TB	2200	120	85	190	1700	0.90	0.70	140	0.220	0.200		
MCD 132-08io1	800	130	85	300	4750	0.8	1.50	125	0.230	0.100	X126b	X126b <b>Y4</b> 
MCD 132-12io1	1200											
MCD 132-14io1	1400											
MCD 132-16io1	1600											
MCD 132-18io1	1800											
➤ MCMA 140PD1200TB	1200	140	85	200	2400	0.85	2.80	140	0.220	0.200	X125b	X125b
➤ MCMA 140PD1600TB	1600											
MCD 161-20io1	2000	165	85	300	6000	0.8	1.60	125	0.155	0.070	X126b	X141b <b>SimBus A</b> 
MCD 161-22io1	2200											
MCD 162-08io1	800	181	85	300	6000	0.88	1.15	125	0.155	0.070		
MCD 162-12io1	1200											
MCD 162-14io1	1400											
MCD 162-16io1	1600											
MCD 162-18io1	1800											
MCMA 200PD1600SA	1600	200	85	300	6000	0.94	1.56	140	0.150	0.075	X141b	
MCD 200-14io1	1400	216	85	340	8000	0.80	1.00	125	0.130	0.050	X126b	
MCD 200-16io1	1600											
MCD 200-18io1	1800											



# Thyristor / Diode Modules

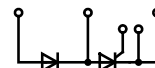

MCD...io1  
MCMA..PD..

$I_{TAV} = 240 - 700 \text{ A}$

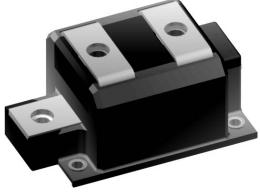

Type	$V_{RRM}$ $V_{DRM}$	$I_{TAV}$	$T_C$	$I_{T(RMS)}$	$I_{TSM}$ 45°C 10 ms	$V_{T0}$	$r_T$	$T_{VJM}$	$R_{thJC}$	$R_{thCH}$	Fig. No.	Package style
➤ New	V	A	°C	A	A	V	mΩ	°C	K/W	K/W		Outline drawings on pages O-30...O-55
MCD 220-08io1	800	250	85	400	8500	0.90	1.00	140	0.139	0.04	X129b	 <p>X126b Y4</p>
MCD 220-12io1	1200											
MCD 220-14io1	1400											
MCD 220-16io1	1600											
MCD 224-20io1	2000	240	85	400	8000	0.8	0.76	130	0.139	0.04	X131b	 <p>X129b Y2</p>
MCD 224-22io1	2200											
MCD 225-12io1	1200	221	85	400	8000	0.8	0.76	130	0.157	0.04	X131b	 <p>X131b Y1</p>
MCD 225-14io1	1400											
MCD 225-16io1	1600											
MCD 225-18io1	1800											
MCD 250-08io1	800	287	85	450	9000	0.85	0.82	140	0.129	0.04	X129b	 <p>X142a ComPack</p>
MCD 250-12io1	1200											
MCD 250-14io1	1400											
MCD 250-16io1	1600											
MCD 250-18io1	1800											
MCD 255-12io1	1200	250	85	450	9000	0.8	0.68	130	0.140	0.04	X131b	
MCD 255-14io1	1400											
MCD 255-16io1	1600											
MCD 255-18io1	1800											
MCMA 260PD1600YB	1600	260	85	400	8300	0.8	1.00	140	0.130	0.08	X126b	
MCMA 265PD1600KB	1600	260	85	408	8500	0.8	0.75	140	0.160	0.04	X131b	
MCD 310-08io1	800	320	85	500	9200	0.8	0.82	140	0.112	0.04	X129b	 <p>X142a ComPack</p>
MCD 310-12io1	1200											
MCD 310-14io1	1400											
MCD 310-16io1	1600											
MCD 310-18io1	1800											
MCD 310-20io1	2000	320	85	500	8000	0.8	0.82	140	0.112	0.04		
MCD 310-22io1	2200											
MCD 312-12io1	1200	320	85	520	9200	0.8	0.68	140	0.120	0.04	X131b	
MCD 312-14io1	1400											
MCD 312-16io1	1600											
MCD 312-18io1	1800											
➤ MCMA 700PD1600CB	1600	700	85	1100	1900	0.82	0.40	140	0.05	0.02	X142a	

For more thyristor / diode modules with higher current, please see pages 138 and 140.

# Thyristor Modules, Dual

$I_{TAV} = 18 - 60 \text{ A}$



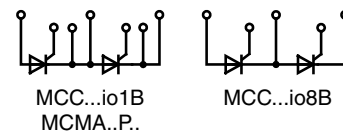

Type	$V_{RRM}$ $V_{DRM}$	$I_{TAV}$	$T_C$	$I_{T(RMS)}$	$I_{TSM}$ 45°C 10 ms	$V_{TO}$	$r_T$	$T_{VJM}$	$R_{thJC}$	$R_{thCH}$	Fig. No.	Package style Outline drawings on pages O-30...O-55
➤ New	V	A	°C	A	A	V	mΩ	°C	K/W	K/W		
MCC 19-08io1B MCC 19-12io1B MCC 19-14io1B MCC 19-16io1B	800 1200 1400 1600	18	85	40	400	0.85	18	125	1.30	0.2	X125a	 X125a <b>TO-240AA</b>   X125c <b>TO-240</b>
MCC 19-08io8B MCC 19-12io8B MCC 19-14io8B MCC 19-16io8B	800 1200 1400 1600	18	85	40	400	0.85	18	125	1.30	0.2	X125c	
MCC 21-08io8B MCC 21-12io8B MCC 21-14io8B MCC 21-16io8B	800 1200 1400 1600	21	85	33	320	0.85	15	125	1.10	0.2	X125c	
➤ MCMA 25P1200TA ➤ MCMA 25P1600TA	1200 1600	25	85	40	400	0.87	13	140	1.20	0.2	X125a	
MCC 26-08io1B MCC 26-12io1B MCC 26-14io1B MCC 26-16io1B	800 1200 1400 1600	27	85	50	520	0.85	11	125	0.88	0.2		
MCC 26-08io8B MCC 26-12io8B MCC 26-14io8B MCC 26-16io8B	800 1200 1400 1600	27	85	50	520	0.85	11	125	0.88	0.2	X125c	
➤ MCMA 35P1200TA ➤ MCMA 35P1600TA	1200 1600	35	85	55	520	0.87	9.8	140	0.90	0.2	X125a	
➤ MCNA 40P2200TA	2200	40	85	63	500	0.84	11.4	140	0.70	0.2		
MCC 44-08io1B MCC 44-12io1B MCC 44-14io1B MCC 44-16io1B MCC 44-18io1B	800 1200 1400 1600 1800	49	85	80	1150	0.85	5.3	125	0.53	0.2	X125c	
MCC 44-08io8B MCC 44-12io8B MCC 44-14io8B MCC 44-16io8B MCC 44-18io8B	800 1200 1400 1600 1800	49	85	80	1150	0.85	5.3	125	0.53	0.2	X125c	
➤ MCMA 50P1200TA ➤ MCMA 50P1600TA	1200 1600	50	85	79	800	0.89	5.3	140	0.70	0.2	X125a	
MCC 56-08io1B MCC 56-12io1B MCC 56-14io1B MCC 56-16io1B MCC 56-18io1B	800 1200 1400 1600 1800	60	85	100	1500	0.85	3.7	125	0.45	0.2		
MCC 56-08io8B MCC 56-12io8B MCC 56-14io8B MCC 56-16io8B MCC 56-18io8B	800 1200 1400 1600 1800	60	85	100	1500	0.85	3.7	125	0.45	0.2	X125c	

# Thyristor Modules, Dual

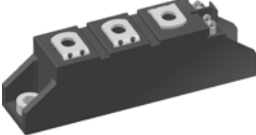

$I_{TAV} = 65 - 181 \text{ A}$

Type	$V_{RRM}$ $V_{DRM}$	$I_{TAV}$	$T_C$	$I_{T(RMS)}$	$I_{TSM}$ 45°C 10 ms	$V_{TO}$	$r_T$	$T_{VJM}$	$R_{thJC}$	$R_{thCH}$	Fig. No.	Package style Outline drawings on pages O-30...O-55
➤ New	V	A	°C	A	A	V	mΩ	°C	K/W	K/W		
➤ MCMA 65P1200TA	1200	65	85	105	1.15	0.85	4.80	140	0.50	0.2	X125a	 <p>X125a TO-240AA</p>
➤ MCMA 65P1600TA	1600											
MCC 72-08io1B	800	85	85	180	1700	0.85	3.20	125	0.30	0.2		
MCC 72-12io1B	1200											
MCC 72-14io1B	1400											
MCC 72-16io1B	1600											
MCC 72-18io1B	1800											
MCC 72-08io8B	800	85	85	180	1700	0.85	3.20	125	0.30	0.2	X125c	
MCC 72-12io8B	1200											
MCC 72-14io8B	1400											
MCC 72-16io8B	1600											
MCC 72-18io8B	1800											
➤ MCMA 85P1200TA	1200	85	85	135	1500	0.85	3.90	140	0.38	0.2	X125a	 <p>X125c TO-240</p>
➤ MCMA 85P1600TA	1600											
MCC 94-20io1B	2000	104	85	180	1700	0.85	3.20	125	0.22	0.2		
MCC 94-22io1B	2200											
MCC 94-24io1B	2400											
MCC 95-08io1B	800	116	85	180	2250	0.8	2.40	125	0.22	0.2		
MCC 95-12io1B	1200											
MCC 95-14io1B	1400											
MCC 95-16io1B	1600											
MCC 95-18io1B	1800											
MCC 95-08io8B	800	116	85	180	2250	0.8	2.40	125	0.22	0.2	X125c	
MCC 95-12io8B	1200											
MCC 95-14io8B	1400											
MCC 95-16io8B	1600											
MCC 95-18io8B	1800											
➤ MCMA 110P1200TA	1200	110	85	170	1900	0.85	3.30	140	0.30	0.2	X125a	 <p>X126a Y4</p>
➤ MCMA 110P1600TA	1600											
➤ MCNA 120P2200TA	2200	120	85	190	1700	0.90	3.70	140	0.22	0.2		
➤ MCMA 140P1200TA	1200	140	85	220	2400	0.85	2.80	140	0.22	0.2		
➤ MCMA 140P1400TA	1400											
➤ MCMA 140P1600TA	1600											
➤ MCMA 140P1800TA	1800											
MCC 132-08io1	800	130	85	300	4750	0.8	1.50	125	0.23	0.1	X126a	
MCC 132-12io1	1200											
MCC 132-14io1	1400											
MCC 132-16io1	1600											
MCC 132-18io1	1800											
MCC 161-20io1	2000	165	85	300	6000	0.8	1.60	125	0.155	0.07		
MCC 161-22io1	2200											
MCC 162-08io1	800	181	85	300	6000	0.88	1.15	125	0.155	0.07		
MCC 162-12io1	1200											
MCC 162-14io1	1400											
MCC 162-16io1	1600											
MCC 162-18io1	1800											

# Thyristor Modules, Dual

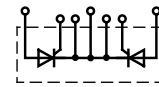

$I_{TAV} = 200 - 700 \text{ A}$

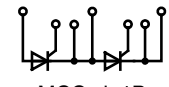

MCK...



MCC...io1B  
MCMA..P..

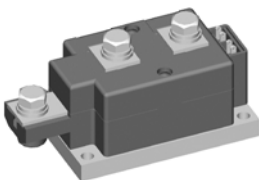
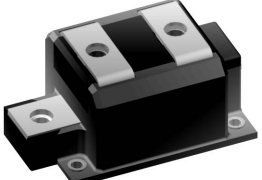

Type	$V_{RRM}$ $V_{DRM}$	$I_{TAV}$	$T_C$	$I_{T(RMS)}$	$I_{TSM}$ 45°C 10 ms	$V_{TO}$	$r_T$	$T_{VJM}$	$R_{thJC}$	$R_{thCH}$	Fig. No.	Package style Outline drawings on pages O-30...O-55
➤ New	V	A	°C	A	A	V	mΩ	°C	K/W	K/W		
MCMA 200P1600SA	1600	200	85	300	6000	0.94	1.56	140	0.150	0.075	X141a	X126a <b>Y4</b> 
MCC 200-14io1	1400	216	85	340	8000	0.8	1.00	125	0.130	0.05	X126a	
MCC 200-16io1	1600											
MCC 200-18io1	1800											
MCK 200-18io1	1800	216	85	340	8000	0.8	1.00	125	0.130	0.05		
MCC 220-08io1	800	250	85	400	8500	0.9	1.00	140	0.139	0.04	X129a	X129a <b>Y2</b> 
MCC 220-12io1	1200											
MCC 220-14io1	1400											
MCC 220-16io1	1600											
MCC 220-18io1	1800											
MCC 224-20io1	2000	240	85	400	8000	0.8	0.76	130	0.139	0.04	X131a	X131a <b>Y1</b> 
MCC 224-22io1	2200											
MCC 224-24io1	2400											
MCC 225-12io1	1200	221	85	400	8000	0.8	0.76	130	0.157	0.04		
MCC 225-14io1	1400											
MCC 225-16io1	1600											
MCC 225-18io1	1800											
MCC 250-08io1	800	287	85	450	9000	0.85	0.82	140	0.129	0.04	X129a	X129a <b>Y1</b> 
MCC 250-12io1	1200											
MCC 250-14io1	1400											
MCC 250-16io1	1600											
MCC 250-18io1	1800											
MCC 255-12io1	1200	250	85	450	9000	0.8	0.68	130	0.14	0.04	X131a	X141a <b>SimBus A</b> 
MCC 255-14io1	1400											
MCC 255-16io1	1600											
MCC 255-18io1	1800											
MCMA 260P1600YA	1600	260	85	400	8300	0.8	1.00	140	0.13	0.08	X126a	X142a <b>ComPack</b> 
MCMA 265P1600KA	1600	260	85	408	8500	0.8	0.75	140	0.16	0.04	X131a	
MCC 310-08io1	800	320	85	500	9200	0.8	0.82	140	0.112	0.04	X129a	
MCC 310-12io1	1200											
MCC 310-14io1	1400											
MCC 310-16io1	1600											
MCC 310-18io1	1800											
MCC 312-12io1	1200	320	85	520	9200	0.8	0.68	140	0.12	0.04	X131a	
MCC 312-14io1	1400											
MCC 312-16io1	1600											
MCC 312-18io1	1800											
➤ MCMA700P1600CA	1600	700	85	1100	19000	0.82	0.40	140	0.05	0.02	X142a	

For more dual thyristor modules with higher current, please see pages 137 and 140.

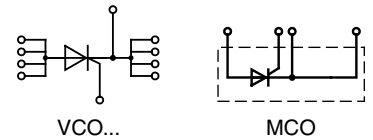
# Thyristor Modules, Single

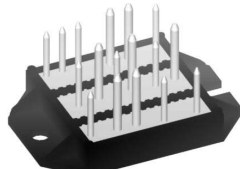

$I_{TAV} = 31 - 830 \text{ A}$

Type	$V_{RRM}$ $V_{DRM}$	$I_{TAV}$	$T_C$	$I_{T(RMS)}$	$I_{TSM}$ 45°C 10 ms	$V_{T0}$	$r_T$	$T_{VJM}$	$R_{thJC}$	$R_{thCH}$	Fig. No.	Package style Outline drawings on pages O-30...O-55		
➤ New	V	A	°C	A	A	V	mΩ	°C	K/W	K/W				
MCO 25-12io1 MCO 25-16io1	1200 1600	31	80	49	370	0.85	14.0	150	1.100	0.50	X027a	SOT-227B miniBLOC 		
MCO 50-12io1 MCO 50-16io1	1200 1600	54	80	85	740	0.90	5.80	150	0.720	0.40				
MCO 75-12io1 MCO 75-16io1	1200 1600	77	80	121	1070	0.85	5.50	150	0.450	0.20				
MCO 100-12io1 MCO 100-16io1	1200 1600	99	80	156	1400	0.85	4.50	150	0.350	0.15				
MCO 150-12io1 MCO 150-16io1	1200 1600	149	80	234	2000	0.80	3.80	150	0.200	0.10				
MCO 450-20io1 MCO 450-22io1	2000 2200	464	85	750	15000	0.77	0.42	130	0.072	0.02			X132a	ECO-PAC 2  See data sheet for pin arrangement
MCO 500-12io1 MCO 500-14io1 MCO 500-16io1 MCO 500-18io1	1200 1400 1600 1800	560	85	880	17000	0.80	0.38	140	0.072	0.02				
MCO 600-16io1 MCO 600-18io1 MCO 600-20io1 MCO 600-22io1	1600 1800 2000 2200	600	85	928	15000	0.77	0.42	140	0.065	0.02				
VCO 132-08io7 VCO 132-12io7 VCO 132-14io7 VCO 132-16io7 VCO 132-18io7	800 1200 1400 1600 1800	130	85	200	3600	0.80	1.65	150	0.25	0.10	X102	Y1 		
VCO 180-08io7 VCO 180-12io7 VCO 180-14io7 VCO 180-16io7 VCO 180-18io7	800 1200 1400 1600 1800	180	90	280	4500	0.75	1.23	150	0.17	0.06				
											X126a	Y4 		

For more single thyristor modules with higher current, please see page 137.

# Optional Accessories for Thyristor / Diode Modules



For module types MCC/MCD/MCO/MCMA 132, 161, 162, 200, 220, 224, 225, 250, 255, 260, 265, 310, 312, 500, 501, 700 and MII 400 (for MCD/MCO only L-type):  
Keyed Gate Cathode twin plugs with wire length = 350 mm  
gate = yellow, cathode = red

Type **ZY 180 L** (L = Left for pin pair 4/5)  
Type **ZY 180 R** (R = Right for pin pair 6/7)

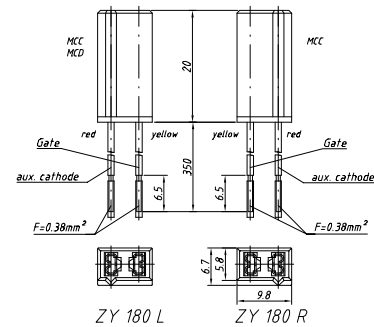

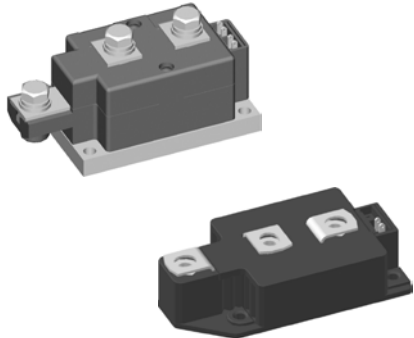

For module-types MCC/MCMA 19, 25, 26, 35, 40, 44, 50, 56, 65, 72, 85, 94, 95, 110, 120 and 140 version 1:  
Keyed Gate Cathode twin plugs with wire length = 350 mm;  
gate = yellow, cathode = red

Type **ZY 200 L** (L = Left for pin pair 4/5)  
Type **ZY 200 R** (R = Right for pin pair 6/7)

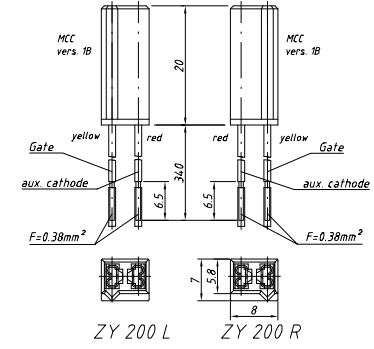

---

For ZY 180 and ZY 200: UL Styles 1385

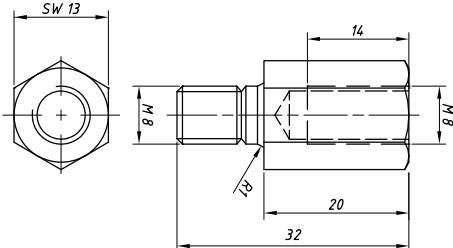

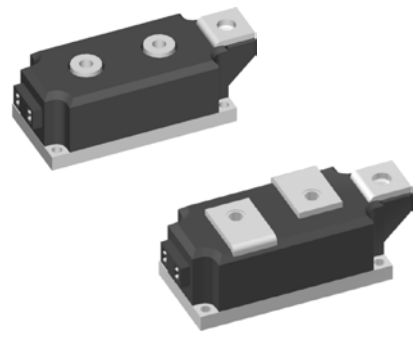

For module types MCC/MCD/MDD 220, 250, 310  
Threaded spacer for higher Anode / Cathode construction:

Type **ZY 250** (material brass)

## Design Information

### For Thyristors, Diodes, Thyristor / Diode Modules and Rectifier Bridges

<b>Surge current</b>	The 60 Hz value of $I_{TSM}$ is 10% higher than the 50 Hz value The $I_{TSM}$ value at $T_{VJM}$ is 10% to 15% lower than the 45°C value
<b>Limiting <math>I^2t</math></b>	50 Hz: $I^2t [A^2s] = I_{TSM} [A] \cdot I_{TSM} [A] \cdot 0.005 [s]$ ; use rated $I_{TSM}$ value (10 ms) 60 Hz: $I^2t [A^2s] = I_{TSM} [A] \cdot I_{TSM} [A] \cdot 0.0042 [s]$ ; use 60-Hz-value of $I_{TSM}$
<b>Forward current</b>	The average current ratings in tables are mostly specified for temperature conditions of: $T_A = 45^\circ C$ , $T_C = 85^\circ C$ or $T_C = 100^\circ C$ . For other temperature conditions the current ratings can be calculated using the following formulas applicable up to 400 Hz.
$I_{TAV} = \frac{-V_{T0} + \sqrt{V_{T0}^2 + 4 \cdot k^2 \cdot r_T \cdot P}}{2 \cdot k^2 \cdot r_T} \quad \text{where} \quad P = \frac{T_{VJM} - T_C}{R_{thJC}} \quad \text{or} \quad P = \frac{T_{VJM} - T_A}{R_{thJA}}$	
$I_{TAV} [A], P [W]; V_{T0} [V]; r_T [\Omega], T_{VJM} [^\circ C], T_C [^\circ C], T_A [^\circ C], R_{thJC} [K/W], R_{thJA} [K/W]$	
$k^2 = 1$ for DC current $k^2 = 2.5$ for sinusoidal half wave current $k^2 = 3$ for 120° rectangular current $k^2 = 6$ for 60° rectangular current	
The average forward current is limited by the RMS current value $I_{T(RMS)}$ . When the <b>calculated</b> value $I_{TAV}$ is higher than $I_{T(RMS)} / k$ , replace it by $I_{TAV} = I_{T(RMS)} / k$ .	

# Rectifier Bridges with Fast Diodes

## 1-phase, B2U

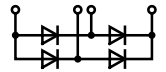

Type	V <sub>RRM</sub>	I <sub>dAV</sub>	@ T <sub>C</sub>	I <sub>FSM</sub> 45°C 10 ms	V <sub>F0</sub>	r <sub>F</sub>	T <sub>VJM</sub>	R <sub>thJC</sub>	R <sub>thCH</sub>	Fig. No.	Package style
➤ New	V	A	°C	A	V	mΩ	°C	K/W	K/W		Outline drawings on pages O-30...O-55
VBE 17-06NO7	600	27	85	50	1.18	22.0	150	2.50	0.30	X101	X024a <b>ISOPLUS i4-PAC™</b>
VBE 17-12NO7	1200	19	85	40	1.32	30.0	150	2.50	0.30		
VBE 20-20NO1	2000	20	65	75	3.30	93.0	150	1.70	0.30	X103	X027a <b>SOT-227B miniBLOC</b>
VBE 26-06NO7	600	44	85	110	1.13	13.0	150	1.60	0.30	X101	
VBE 26-12NO7	1200	32	85	90	1.32	30.0	150	1.60	0.30		X030a <b>SMPD-B</b>
VBE 55-06NO7	600	68	100	250	0.98	8.0	150	0.90	0.30		
VBE 55-12NO7	1200	59	85	200	1.31	15.0	150	0.90	0.30		
VBE 60-06A	600	60	90	250	0.98	6.8	150	1.15	0.10	X027a	
➤ DPG60B600LB	600	60	110	250	0.84	19.6	175	1.10	0.40	X030a	
FBE 22-06N1	600	22	115	50	1.04	24.0	175	3.00	0.20	X024a	
VBE 100-06NO7	600	100	85	600	1.09	4.3	150	0.80	0.20	X102	
VBE 100-12NO7	1200	100	70	500	1.07	8.2	150	0.80	0.20		
FBS 10-06SC*	600	6.6	90	12	-	-	175	8.00	3.50	X024a	X030a <b>SMPD-B</b>
FBS 16-06SC*	600	11	90	20	-	-	175	5.60	3.00		
➤ FBS 10-12SC*	1200	9	80	100	-	-	175	7.00	3.50		

\* SiC-Diodes

## 3-phase, B6U

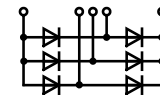

FUS 45-0045B	45	45	130	150	0.30	14.8	150	3.00	0.20	X024a	X101 <b>ECO-PAC 1</b>
➤ DHG 60U1200LB	1200	62	80	200	-	-	150	1.10	0.75	X030a	
VUE 50-12NO1	1200	50	85	200	1.65	18.2	150	1.20	0.30	X103	See data sheet for pin arrangement
VUE 30-20NO1	2000	30	65	75	3.30	93.0	150	1.70	0.30		
VUE 22-06NO7	600	34	85	50	1.18	22.0	150	2.50	0.30	X101	X102 <b>ECO-PAC 2</b>
VUE 22-12NO7	1200	24	85	40	1.39	55.0	150	2.50	0.30		
VUE 35-06NO7	600	56	85	110	1.13	13.0	150	1.60	0.30		See data sheet for pin arrangement
VUE 35-12NO7	1200	40	85	90	1.32	30.0	150	1.60	0.30		
VUE 75-06NO7	600	86	100	250	0.98	8.0	150	0.90	0.30		X103 <b>V1-A-Pack</b>
VUE 75-12NO7	1200	74	85	200	1.31	15.0	150	0.90	0.30		
FUE 30-12N1	1200	30	120	90	0.97	48.0	175	2.30	0.20	X024a	
VUE 130-06NO7	600	130	85	600	1.09	4.3	150	0.80	0.20	X102	
VUE 130-12NO7	1200	130	70	500	1.07	8.2	150	0.80	0.20		

## Rectifier Bridges incorporating Fast Diodes

Power switching semiconductors are used in inverter systems with DC-Link. Due to high switching frequencies, harmonics and line distortion may be generated. It is important that the new designs reduce these influences and fulfill the EMI filtering requirements according to EMI/EMC VDE 0871 and other.

The noise level can be reduced by up to **10dB** when the input rectifier is equipped with semi-fast diodes and is therefore optimised for turn off; resulting in a lower peak recovery current compared to non-optimised and normal rectifier diodes.

The noise level can be further reduced approximately by another **5dB** when using rectifier bridges equipped with Fast Recovery Epitaxial Diodes (FRED) like module types VBE (single phase bridge) or VUE (three phase bridge). However these are more expensive but may be necessary in some applications to fulfill the VDE or other standards.

This behaviour has a direct influence on the design of the EMI filter networks with its capacitors and inductors of which the size and costs can be reduced.

More detailed information is available in the IXYS application note D98005E „Input Rectifiers with Semi-fast Diodes for DC Link“ on [www.ixys.com](http://www.ixys.com).

# 1~ Rectifier Bridges

## 1~ Rectifier Bridges with Avalanche Diodes, B2U

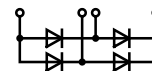

Type	$V_{RRM}$	$V_{VRMS}$	$I_{dAV}$	@ $T_C$	$I_{FSM}$ 45°C 10 ms	$V_{FO}$	$r_F$	$T_{VJM}$	$R_{thJC}$	$R_{thJH}$	$P_{RSM}$	Fig. No.	Package style
	V	V											
VBO 13-12AO2	1200	400	18	85	220	0.85	17.0	150	5.60	6.00	2.5	X115	Outline drawings on pages O-30...O-55
VBO 13-16AO2	1600	500											
VBO 20-12AO2	1200	400	31	85	300	0.85	14.0	150	3.00	3.40	3.4		
VBO 20-16AO2	1600	500											
VBO 25-12AO2	1200	400	38	85	370	0.85	8.0	150	2.80	3.20	3.4		
VBO 25-16AO2	1600	500											

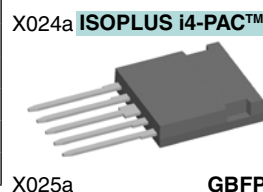

X024a

GBFP

## 1~ Rectifier Bridges with Standard Diodes, B2U

VBO 13-08NO2	800	250	18	85	220	0.85	17.0	150	5.60	6.00	-	X115
VBO 13-12NO2	1200	400										
VBO 13-16NO2	1600	500	20	130	150	0.81	32	175	3.00	5.00	-	X024a
FBO 16-12N	1200	400										
VBO 20-08NO2	800	250	31	85	300	0.85	14.0	150	3.00	3.40	-	X115
VBO 20-12NO2	1200	400										
VBO 20-16NO2	1600	500	20	115	120	0.84	28.8	150	2.50	2.90	-	X101
VBO 21-08NO7	800	250										
VBO 21-12NO7	1200	400	17	85	380	0.85	12.0	150	8.20	9.40	-	X116b
VBO 22-08NO8	800	250										
VBO 22-12NO8	1200	400	25	80	370	0.89	12.2	150	4.30	4.80	-	X025a
VBO 22-16NO8	1600	500										
VBO 22-18NO8	1800	575	38	85	370	0.85	8.0	150	2.80	3.20	-	X115
GBO 25-12NO1	1200	400										
GBO 25-16NO1	1600	500	35	85	400	0.85	12.0	150	2.80	3.40	-	X119b
VBO 25-08NO2	800	250										
VBO 25-12NO2	1200	400	23	85	550	0.80	5.8	150	6.20	7.40	-	X116b
VBO 25-16NO2	1600	500										
VBO 30-08NO7	800	250	40	130	300	0.79	14.0	175	1.50	1.70	-	X024a
VBO 30-12NO7	1200	400										
VBO 30-16NO7	1600	500	40	100	300	0.80	13.0	150	1.70	2.00	-	X027a
VBO 30-18NO7	1800	575										
VBO 36-08NO8	800	250	50	64	750	0.85	8.0	150	2.60	2.84	-	X120b
VBO 36-12NO8	1200	400										
VBO 36-16NO8	1600	500	60	115	550	0.78	8.1	150	1.10	1.50	-	X122b
VBO 36-18NO8	1800	575										
FBO 40-12N	1200	400	55	105	300	0.82	12.2	150	1.10	1.50	-	X101
VBO 40-08NO6	800	250										
VBO 40-12NO6	1200	400	70	105	550	0.81	7.8	150	0.90	1.30	-	X101
VBO 40-16NO6	1600	500										
VBO 50-08NO7	800	250	70	110	750	0.78	6.0	150	0.90	1.30	-	X122b
VBO 50-12NO7	1200	400										
VBO 50-16NO7	1600	500	70	110	750	0.78	6.0	150	0.90	1.30	-	X122b
VBO 50-18NO7	1800	575										
VBO 52-08NO7	800	250	70	110	750	0.78	6.0	150	0.90	1.30	-	X122b
VBO 52-12NO7	1200	400										
VBO 52-16NO7	1600	500	70	110	750	0.78	6.0	150	0.90	1.30	-	X122b
VBO 52-18NO7	1800	575										
VBO 54-08NO7	800	250	70	110	750	0.78	6.0	150	0.90	1.30	-	X122b
VBO 54-12NO7	1200	400										
VBO 54-16NO7	1600	500	70	110	750	0.78	6.0	150	0.90	1.30	-	X122b
VBO 54-18NO7	1800	575										
VBO 68-08NO7	800	250	70	110	750	0.78	6.0	150	0.90	1.30	-	X122b
VBO 68-12NO7	1200	400										
VBO 68-16NO7	1600	500	70	110	750	0.78	6.0	150	0.90	1.30	-	X122b
VBO 68-18NO7	1800	575										

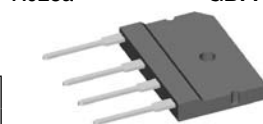

X027a

SOT-227B  
miniBLOC

X101

ECO-PAC 1

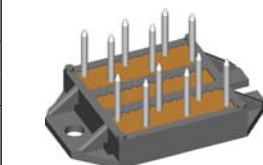

See data sheet for pin arrangement

X115

FO-A



X116b

FO-B

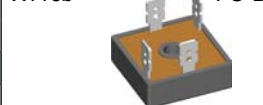

X119b

PWS-A

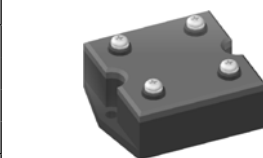

X120b

PWS-B

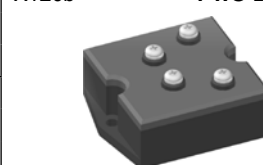

X122b

PWS-D







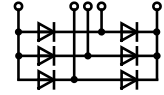

# 3~ Rectifier Bridges

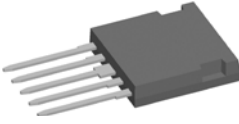
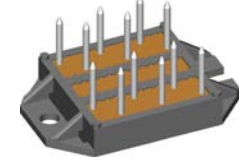
## 3~ Rectifier Bridges with Standard Diodes, B6U

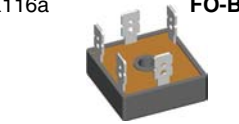
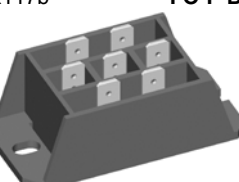





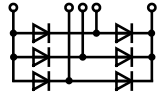

Type	V <sub>RRM</sub>	V <sub>VRMS</sub>	I <sub>dAV</sub>	@ T <sub>C</sub>	I <sub>FSM</sub> 45°C 10 ms	V <sub>F0</sub>	r <sub>F</sub>	T <sub>VJM</sub>	R <sub>thJC</sub>	R <sub>thJH</sub>	Fig. No.	Package style
○ Not for new design ➤ New	V	V	A	°C	A	V	mΩ	°C	K/W	K/W		Outline drawings on pages O-30...O-55
FUO 22-12N	1200	400	30	120	150	0.81	31.0	175	3.00	3.20	X024a	X024a <b>ISOPLUS i4-PAC™</b>
FUO 22-16N	1600	500										
VUO 22-08NO1	800	250	22		100	0.80	40.0	130	-	3.10	X103	X025b <b>GUPF</b> 
VUO 22-12NO1	1200	400										
VUO 22-14NO1	1400	440										
VUO 22-16NO1	1600	500										
VUO 22-18NO1	1800	575										
			T <sub>H</sub> = 90°C									
VUO 25-08NO8	800	250	20	85	380	0.85	12.0	150	9.30	10.20	X116a	X101 <b>ECO-PAC 1</b> 
VUO 25-12NO8	1200	400										
VUO 25-14NO8	1400	440										
VUO 25-16NO8	1600	500										
VUO 25-18NO8	1800	575										
VUO 28-08NO7	800	250	30	105	120	0.84	28.8	150	2.50	2.90	X101	
VUO 28-12NO7	1200	400										
VUO 36-08NO8	800	250	27	85	550	0.80	7.4	150	7.50	8.40	X116a	X103 <b>V1-A-Pack</b>  See data sheet for pin arrangement
VUO 36-12NO8	1200	400										
VUO 36-14NO8	1400	440										
VUO 36-16NO8	1600	500										
VUO 36-18NO8	1800	575										
VUO 34-08NO1	800	250	36		300	0.80	15.0	130	-	2.50	X103	
VUO 34-12NO1	1200	400										
VUO 34-14NO1	1400	440										
VUO 34-16NO1	1600	500										
VUO 34-18NO1	1800	575										
VUO 30-08NO3	800	250	37	85	300	0.90	11.0	125	2.40	3.00	X117b	
VUO 30-12NO3	1200	400										
VUO 30-14NO3	1400	440										
VUO 30-16NO3	1600	500										
VUO 30-18NO3	1800	575										
VUO 35-08NO7	800	250	38	85	400	0.85	12.0	150	4.20	4.80	X119a	X116a <b>FO-B</b> 
VUO 35-12NO7	1200	400										
VUO 35-14NO7	1400	440										
VUO 35-16NO7	1600	500										
VUO 35-18NO7	1800	575										
GUO 40-08NO1	800	250	40	85	370	0.86	12.9	175	4.30	5.00	X025b	X117b <b>FO-F-B</b> 
GUO 40-12NO1	1200	400										
GUO 40-16NO1	1600	500										
FUO 50-16N	1600	500	50	120	270	0.78	17	175	2.10	2.30	X024a	X119a <b>PWS-A</b> 
VUO 52-08NO1	800	250	60	110	350	0.83	11.5	150	1.30	1.60	X103	
VUO 52-12NO1	1200	400										
VUO 52-14NO1	1400	440										
VUO 52-16NO1	1600	500										
VUO 52-18NO1	1800	500										
VUO 52-20NO1	2000	575										
VUO 52-22NO1	2200	690										
VUO 50-08NO3	800	250	58	85	500	0.90	6.0	125	1.62	2.22	X117b	X120a <b>PWS-B</b> 
VUO 50-12NO3	1200	400										
VUO 50-14NO3	1400	440										
VUO 50-16NO3	1600	500										
VUO 50-18NO3	1800	575										
VUO 55-12NO7	1200	400	58	85	750	0.85	8.0	150	2.70	3.06	X120a	
VUO 55-14NO7	1400	440										
VUO 55-16NO7	1600	500										
VUO 55-18NO7	1800	575										
VUO 60-12NO3	800	250	72	85	600	0.80	6.5	125	1.20	1.60	X117b	
VUO 60-14NO3	1400	440										
VUO 60-16NO3	1600	500										
VUO 60-18NO3	1800	575										

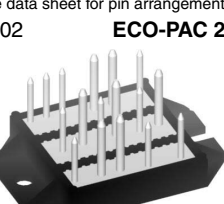
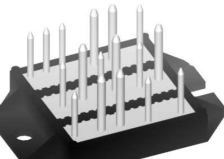
### 3~ Rectifier Bridges

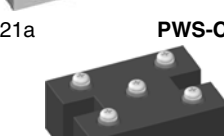



#### 3~ Rectifier Bridges with Standard Diodes, B6U

Type	V <sub>RRM</sub>	V <sub>VRMS</sub>	I <sub>dAV</sub>	@ T <sub>C</sub>	I <sub>FSM</sub> 45°C 10 ms	V <sub>F0</sub>	r <sub>F</sub>	T <sub>VJM</sub>	R <sub>thJC</sub>	R <sub>thJH</sub>	Fig. No.	Package style
○ Not for new design												Outline drawings on pages O-30...O-55
➤ New	V	V	A	°C	A	V	mΩ	°C	K/W	K/W		
VUO 62-08NO7	800	250	60	120	550	0.78	8.1	150	1.10	1.50	X122a	X030a <b>SMPD-B</b> 
VUO 62-12NO7	1200	400										
VUO 62-14NO7	1400	440										
VUO 62-16NO7	1600	500										
VUO 62-18NO7	1800	575										
VUO 64-16NO7	1600	500	60	120	550	0.78	8.1	150	1.10	1.50	X122c	X101 <b>ECO-PAC 1</b> 
VUO 68-08NO7	800	250	70	105	300	0.82	12.2	150	1.10	1.50	X101	X102 <b>ECO-PAC 2</b> 
VUO 68-12NO7	1200	400										
VUO 68-14NO7	1400	440										
VUO 68-16NO7	1600	500										
○ VUO 70-16NO7	1600	500	70	100	550	0.80	8.0	150	1.45	1.90	X118d	See data sheet for pin arrangement
VUO 80-08NO1	800	250	82	T <sub>H</sub> = 90°C	600	0.80	7.5	150	-	1.42	X103	X103 <b>ECO-PAC 2</b> 
VUO 80-12NO1	1200	400										
VUO 80-14NO1	1400	440										
VUO 80-16NO1	1600	500										
VUO 80-18NO1	1800	575										
VUO 82-08NO7	800	250	90	115	750	0.78	6.0	150	0.90	1.30	X122a	See data sheet for pin arrangement
VUO 82-12NO7	1200	400										X103 <b>V1-A-Pack</b> 
VUO 82-14NO7	1400	440										
VUO 82-16NO7	1600	500										
VUO 82-18NO7	1800	575										
VUO 84-16NO7	1600	500	90	115	750	0.78	6.0	150	0.90	1.30	X122c	X104 <b>V2-Pack</b> 
VUO 86-08NO7	600	125	90	105	550	0.81	7.8	150	0.90	1.30	X101	
VUO 86-12NO7	1200	400										
VUO 86-14NO7	1400	440										
VUO 86-16NO7	1600	500										
➤ DMA 90U1800LB	1800	575	99	80	320	-	-	175	1.10	1.50	X030a	X112 <b>E2-Pack</b> 
VUO 98-08NO7	800	250	105	115	750	0.81	5.9	150	0.70	1.00	X102	
VUO 98-12NO7	1200	400										
VUO 98-16NO7	1600	500										
VUO 105-12NO7	1200	400	140	85	1500	0.80	5.0	150	0.83	1.13	X121a	X121a <b>PWS-C</b> 
VUO 105-14NO7	1400	440										
VUO 105-16NO7	1600	500										
VUO 105-18NO7	1800	575										
VUO 110-08NO7	800	250	125	110	1200	0.79	4.5	150	0.70	1.00	X123c	X122a <b>PWS-D</b> 
VUO 110-12NO7	1200	400										
VUO 110-14NO7	1400	440										
VUO 110-16NO7	1600	500										
VUO 110-18NO7	1800	575										
➤ VUO 120-12NO2T	1200	400	188	80	1100	0.87	4.0	150	0.60	0.80	X104	X122c <b>PWS-D Flat</b> 
➤ VUO 120-16NO2T	1600	500										
VUO 121-16NO1	1600	500	120	105	700	0.80	7.6	150	0.65	0.75	X112	X123c <b>PWS-E</b> 
VUO 122-08NO7	800	250	125	115	1000	0.80	4.6	150	0.60	0.90	X102	
VUO 122-12NO7	1200	400										
VUO 122-14NO7	1400	440										
VUO 122-16NO7	1600	500										
VUO 125-12NO7	1200	400	166	85	1800	0.80	3.0	150	0.83	1.13	X121a	
VUO 125-14NO7	1400	440										
VUO 125-16NO7	1600	500										
VUO 125-18NO7	1800	575										

### 3~ Rectifier Bridges

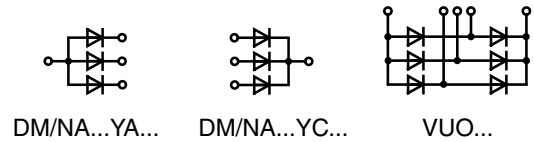
#### 3~ Rectifier Bridges with Standard Diodes, B6U



Type	$V_{RRM}$	$V_{VRMS}$	$I_{dAV}$ @ $T_C$		$I_{FSM}$ 45°C 10 ms	$V_{FO}$	$r_F$	$T_{VJM}$	$R_{thJC}$	$R_{thJH}$	Fig. No.	Package style
New	V	V	A	°C	A	V	mΩ	°C	K/W	K/W		Outline drawings on pages O-30...O-55
➤ DNA 90YA2200NA ➤ DNA 90YC2200NA	2200	690	90	85	370	0.86	11.4	150	1.20	1.30	X027a	<b>SOT-227B miniBLOC</b> 
DMA 150YA1600NA DMA 150YC1600NA	1600	500	150	85	700	0.85	5.3	150	0.75	0.85		
VUO 160-08NO7 VUO 160-12NO7 VUO 160-14NO7 VUO 160-16NO7 VUO 160-18NO7	800 1200 1400 1600 1800	250 400 440 500 575	175	110	1800	0.77	3.4	150	0.50	0.70	X123c	<b>V1-A-Pack</b> 
VUO 162-16NO7	1600	500	175	110	1800	0.77	3.4	150	0.50	0.70	X123h	
VUO 190-08NO7 VUO 190-12NO7 VUO 190-14NO7 VUO 190-16NO7 VUO 190-18NO7	800 1200 1400 1600 1800	250 400 440 500 575	240	110	2800	0.74	2.4	150	0.40	0.55	X123c	<b>X103</b>
VUO 192-16NO7	1600	500	240	110	2800	0.74	2.4	150	0.40	0.55	X123h	

#### 3~ Rectifier Bridges with IGBT and Fast Diode for Brake Unit

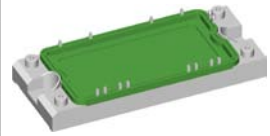
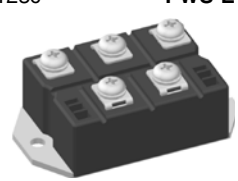
Type	Rectifier			IGBT		Fast Diode			Fig. No.	
	$V_{RRM}$ V	$I_{dAV}$ A	@ $T_C$ °C	$V_{CES}$ V	$I_{C80}$ A	$V_{RRM}$ V	$I_{F(AV)}$ A	$t_{rr}$ ns		
➤ VUB 72-12NOXT VUB 72-16NOXT	1200 1600	110	80	1200	40	1200	15	130	X103	<b>X104</b> <b>V2-Pack</b> 
VUI 72-16NOXT	1600	110	80	1200	40	-	-	-		
VUB 116-16NOXT	1600	116	100	1200	84	1200	27	40	X112	<b>X112</b> <b>E2-Pack</b> 
VUB 120-16NOX VUB 120-16NOXT	1600	188	80	1200	108	1200	34	40	X104	
VUB 135-22NO1	2200	135	100	1700	50	1800	50	40	X112	<b>X123c</b> <b>PWS-E</b> 
VUB 145-16NOXT VUB 160-16NOX VUB 160-16NOXT	1600 1600 1600	145 188 188	100 80 80	1200 1200 1200	108 154 108	1200 1200 1200	27 34 34	40 40 40	X104	
MDMA240UB1600ED	1600	240	80	1200	108	1200	59	350	X112	

### 3~ Half Controlled Rectifier Bridges



#### with IGBT and Fast Diode for Brake Unit

Type	Rectifier			IGBT		Fast Diode			Fig. No.	
	$V_{RRM}$ V	$I_{dAV}$ A	@ $T_C$ °C	$V_{CES}$ V	$I_{C80}$ A	$V_{RRM}$ V	$I_{F(AV)}$ A	$t_{rr}$ ns		
➤ VVZB 120-16ioX	1600	120	80	1200	108	1200	27	40	X104	<b>X123h</b> <b>PWS-E Flat</b> 
➤ MCNA120UI2200TED	2200	120	80	1700	80	1700	50	550	X112	
VVZB 135-16ioXT	1600	135	85	1200	84	1200	27	40		
VVZB 170-16ioXT	1600	170	85	1200	108	1200	27	40		
➤ MCMA240UI1600ED	1600	240	80	1200	108	1200	59	350		

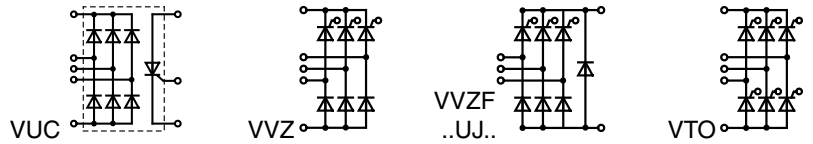
# 3~ Rectifier Bridges

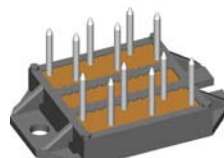

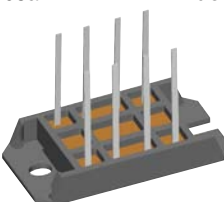
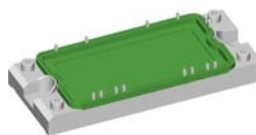
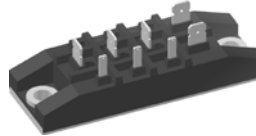
Type	V <sub>RRM</sub> V	V <sub>VRMS</sub> V	I <sub>dAVM</sub> A	@ T <sub>H</sub> °C	I <sub>FSM/TSM</sub> 10 ms, 45°C A	V <sub>TO</sub> V	r <sub>T</sub> mΩ	T <sub>VJM</sub> °C	R <sub>thJC</sub> K/W	R <sub>thJH</sub> K/W	Fig. No.	Package style Outline drawings on pages O-30...O-55
<b>3~ Rectifier Bridges with Fast Diodes (t<sub>tr</sub> = 1.5 ms) &amp; Integrated Softstart Thyristor</b>												
VUC 36-12go2	1200	400	34	85	Dio. 300	1.20	16.0	125	1.40	2.00	X105a	X101 <b>ECO-PAC 1</b>  See data sheet for pin arrangement
					Thy. 400	0.85	10.0	125	0.90	1.10		
VUC 36-16go2	1600	500	34	85	Dio. 300	1.20	16.0	125	1.40	2.00		
					Thy. 400	0.85	10.0	125	0.90	1.10		

Type	V <sub>RRM</sub> V	V <sub>VRMS</sub> V	I <sub>dAV</sub> T <sub>C</sub> = 85°C A	I <sub>TSM</sub> 10 ms 45°C A	V <sub>TO</sub> V	r <sub>T</sub> mΩ	T <sub>VJM</sub> °C	R <sub>thJC</sub> K/W	R <sub>thJH</sub> K/W	Fig. No.	Package style
○ Not for new design	V	V	A	A	V	mΩ	°C	K/W	K/W		
<b>3~ Half Controlled Rectifier Bridges, B6HK</b>											
VVZ 12-12io1	1200	400	15	110	1.10	30.0	125	2.50	3.10	X105a	X105a <b>V1-B-Pack</b> 
VVZ 12-16io1	1600	500	T <sub>H</sub> = 100°C								
VVZ 24-12io1	1200	400	21	300	1.00	16.0	125	2.10	2.70	X105a	X112 <b>E2-Pack</b> 
VVZ 24-16io1	1600	500	T <sub>H</sub> = 100°C								
VVZ 39-08ho7	800	250	39	200	0.85	27.0	125	1.30	1.80	X101	X118c <b>FO-T-A</b> 
VVZ 39-12ho7	1200	400									
VVZ 40-12io1	1200	400	34	320	0.85	15.0	125	1.00	1.60	X105a	X123b <b>PWS-E</b> 
VVZ 40-16io1	1600	500	T <sub>H</sub> = 100°C								
VVZ 110-12io7	1200	400	110	1150	0.85	6.0	125	0.65	0.80	X123b	
VVZ 175-12io7	1200	400	167	1500	0.85	3.5	125	0.46	0.55		
VVZ 175-16io7	1600	500									
<b>3~ Half Controlled Rectifier Bridges with free wheeling diode, B6HKF</b>											
MCMA120UJ1800ED	1800	575	120	500	0.89	13.6	150	0.65	0.75	X112	
○ VVZF 70-16io7	1600	500	70	550	0.85	11.0	125	0.90	1.10	X118c	
<b>3~ Full Controlled Rectifier Bridges, B6C</b>											
VTO 39-08ho7	800	250	39	200	0.85	27.0	125	1.30	1.80	X101	
VTO 39-12ho7	1200	400									

# AC Controller 1~ / 2~ / 3~

$I_{RMS} = 30 - 230 \text{ A}$

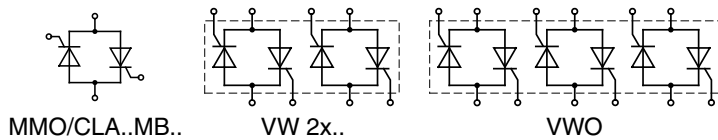

Type	$V_{RRM}$	$V_{VRMS}$	$I_{RMS}$	@ $T_c$	$I_{TSM}$ 10 ms 45°C	$V_{TO}$	$r_T$	$T_{VJM}$	$R_{thJC}$	$R_{thJH}$	Fig. No.	Package style	
➤ New	V	V	A	°C	A	V	mΩ	°C	K/W	K/W		Outline drawings on pages O-30...O-55	
1~	MMO 62-12io6	1200	400	54	110	400	0.85	12.0	150	0.91	1.01	X027a	<b>SOT-227B miniBLOC</b> 
	MMO 62-16io6	1600	500										
	MMO 74-12io6	1200	400	74	110	600	0.85	8.4	150	0.71	0.81	X101	<b>ECO-PAC 1</b> 
	MMO 74-16io6	1600	500										
	MMO 90-12io6	1200	400	90	110	800	0.90	5.8	150	0.60	0.70		
	MMO 90-14io6	1400	440										
	MMO 90-16io6	1600	500										
	CLA 110MB1200NA	1200	400	110	110	1100	0.78	4.9	150	0.55	0.65		
	MMO 110-08io7	800	250	112	85	1000	0.85	5.6	150	0.80	0.92	X101	<b>ECO-PAC 1</b> 
	MMO 110-12io7	1200	400										
	MMO 110-14io7	1400	440										
	MMO 140-08io7	800	250	130	85	1150	0.85	5.2	150	0.70	0.82	X102	<b>ECO-PAC 2</b> 
	MMO 140-12io7	1200	400										
	MMO 140-16io7	1600	500										
	MMO 175-08io7	800	250	175	85	1500	0.85	3.7	150	0.50	0.62	X102	<b>ECO-PAC 2</b> 
MMO 175-12io7	1200	400											
MMO 175-16io7	1600	500											
MMO 230-08io7	800	250	230	85	2250	0.80	2.4	125	0.26	0.46	X102	<b>ECO-PAC 2</b> 	
MMO 230-12io7	1200	400											
MMO 230-14io7	1400	440											
MMO 230-16io7	1600	500											
MMO 230-18io7	1800	575											
2~	VW 2x30-12io1	1200	400	2x 30	85	200	0.80	25.0	125	1.70	2.00	X103	<b>V1-A-Pack</b> 
	VW 2x30-14io1	1400	440										
	VW 2x30-16io1	1600	500										
	VW 2x45-12io1	1200	400	2x 45	85	300	0.85	15.0	125	1.25	1.55	X104	<b>V2-Pack</b> 
	VW 2x45-14io1	1400	440										
	VW 2x45-16io1	1600	500										
VW 2x60-12io1	1200	400	2x 60	85	520	0.85	11.0	125	0.92	1.22	X104	<b>V2-Pack</b> 	
VW 2x60-14io1	1400	440											
VW 2x60-16io1	1600	500											
3~	VWO 35-08ho7	800	250	3x 35	85	200	0.85	27.0	125	1.30	1.80	X101	
	VWO 35-12ho7	1200	400										
	VWO 85-12io1	1200	400	3x 83	85	520	0.85	11.0	150	0.92	1.22	X104	<b>TO-247AD</b> 
	VWO 85-14io1	1400	440										
	VWO 85-16io1	1600	500										
	VWO 140-12io1	1200	400	3x 143	85	1150	0.85	5.2	150	0.60	0.70	X104	<b>ISO247</b> 
VWO 140-14io1	1400	440											
VWO 140-16io1	1600	500											

## TRIAC 1~

$I_{RMS} = 60 \text{ A}$

➤ CLA60MT1200NHB	1200	400	60	120	300	0.86	12.5	150	0.55	0.25	X014a
➤ CLA60MT1200NTZ										0.15	X019a
➤ CLA60MT1200NHR									0.90	0.25	X016c

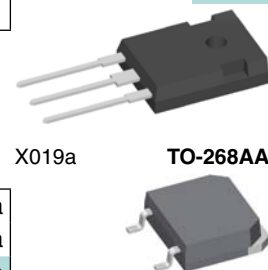
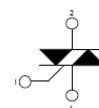

# 1~ / 3~ High Voltage Rectifier Modules

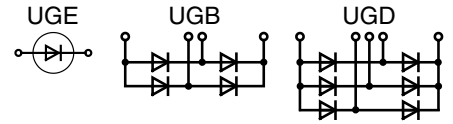

Type	$V_{RRM}$ V	$I_{dAV}$ ① / ② A	$I_{FSM}$ 10 ms, 45°C A	$V_{F0}$ V	$r_F$ mΩ	$T_{VJM}$ °C	$R_{thJA1}$ ① K/W	$R_{thJA2}$ ② K/W	Fig. No.	Package style Outline drawings on pages O-30...O-55
<b>UGE 0421AY4</b>	3200	23 / 7.4	300	1.70	16	150	1.9	7.1	X251	
<b>UGE 0221AY4</b>	4800	10 / 3.8	180	2.55	90	150	1.7	8.0		
<b>UGE 1112AY4</b>	8000	4.2 / 2.0	120	4.25	215	150	4.2	10.0		
<b>UGE 3126AY4</b>	24000	2.0 / 0.8	70	12.00	1800	150	2.7	8.7		
<b>UGB 3132AD</b>	4800	1.3	60	-	-	150	-	-	X252	
<b>UGB 6124AG</b>	10500	1.0	50	-	-	150	-	-	X253b	
<b>UGD 6123AG</b>	7200	1.8	50	-	-	150	-	-	X253a	
<b>UGD 8124AG</b>	10500	1.2	50	-	-	150	-	-		

Data according to IEC 60747-2/6

① for oil-cooling with cooling plate,  $T_A = 35^\circ\text{C}$

② for natural air cooling without cooling plate,  $T_A = 45^\circ\text{C}$

X253b UGB



X253a UGD



X252 UGB



X251 UGE

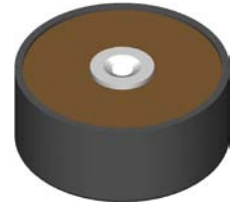

# Braking Rectifier Assemblies

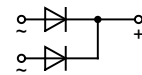

VGF 0136 AH

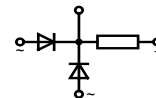

VGF 0136 AB

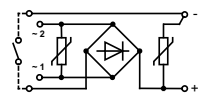

VGB 0124 AY7

Type	$V_{VRMS}$ typ. V	$V_{dAV}$ typ. V	$I_{dAVM}$ typ. A	$I_{dAVM}$ max. A	$V_{RRM}$ max. V	$I_{FSM}$ max. A	$I^2t$ max. A <sup>2</sup> s	Fig. No.	Package style Outline drawings on pages O-30...O-55
<b>VGB 0124AY7a</b>	380	340	1.0	1.0	1400	60	28	X254	
<b>VGF 0136AB</b>	1000	440	1.2	1.5	2800	80	40	X255	
<b>VGF 0136AH</b>	1000	440	0.6	1.1	1400	60	28	X256	

X254 VG-A

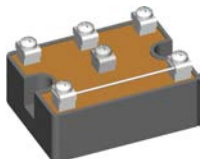

X255 VG-B

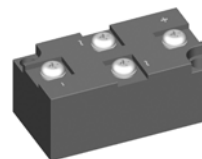

X256 VG-C

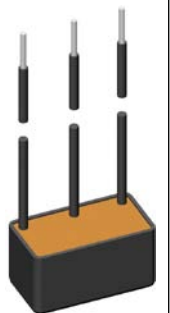

# Break-Over Diodes

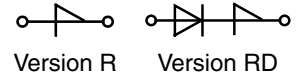

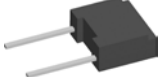
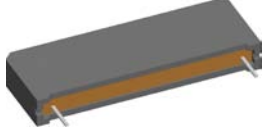
Type	$V_{BO}$ $T_{VJ} = 25\text{ °C}$ $K_T = 2 \cdot 10^{-3}\text{ K}^{-1}$ V	$I_{BO}$ mA	$I_H$ mA	$V_H$ V	$I_D$ $T_{VJ} = 125\text{ °C}$ $V_D = 0.8 \cdot V_{BO}$ $\mu\text{A}$	$I_{AVM}$ ① $T_{amb} = 50\text{ °C}$ A	$I_{SM}$ A	dv/dt V/ $\mu\text{s}$	$R_{thJA}$ K/W	Fig. No.	Package style Outline drawings on pages O-30...O-55
IXBOD 1-06 IXBOD 1-07 IXBOD 1-08 IXBOD 1-09 IXBOD 1-10	600 $\pm$ 50 700 800 900 1000	< 15	30	4-8	20	0.90	200	>1000	60	X201	X201 <b>FP-Case</b> (oil proof) 
IXBOD 1-12R IXBOD 1-12RD IXBOD 1-13R IXBOD 1-13RD IXBOD 1-14R IXBOD 1-14RD IXBOD 1-15R IXBOD 1-15RD IXBOD 1-16R IXBOD 1-16RD IXBOD 1-17R IXBOD 1-17RD IXBOD 1-18R IXBOD 1-18RD IXBOD 1-19R IXBOD 1-19RD IXBOD 1-20R IXBOD 1-20RD	1200 $\pm$ 50 1300 1400 1500 1600 1700 1800 1900 2000	< 15	30	4-8	100	0.90	200	>1500	20	X202	X202 <b>BOD-Package</b> 
IXBOD 1-21R IXBOD 1-21RD IXBOD 1-22R IXBOD 1-22RD IXBOD 1-23R IXBOD 1-23RD IXBOD 1-24R IXBOD 1-24RD IXBOD 1-25R IXBOD 1-25RD	2100 $\pm$ 50 2200 2300 2400 2500	< 15	30	4-8	100	0.90	200	>2500	20		
IXBOD 1-26R IXBOD 1-26RD IXBOD 1-28R IXBOD 1-28RD IXBOD 1-30R IXBOD 1-30RD IXBOD 1-32R IXBOD 1-32RD	2600 $\pm$ 100 2800 3000 3200	< 15	30	4-8	100	0.90	200	>3500	20		
IXBOD 1-34R IXBOD 1-36R IXBOD 1-38R IXBOD 1-40R IXBOD 1-42R	3400 $\pm$ 100 3600 3800 4000 4200	< 15	30	4-8	100	0.90	200	>3500	20		

① Leads soldered on PCB board,  $T_{sg}$  and  $T_{VJ} = -40 \dots +125\text{ °C}$

## Break-Over-Diodes Sets

We deliver also:

- Special selection of more than 2 pcs IXBOD1-... for every break down voltage of  $V_{BO} > 2000\text{ V}$

- Example

type designation IXBOD Set SA05/00

$V_{BO} = 4700\text{ V} \pm 100\text{ V}$

(we deliver 5 pcs single selected IXBOD1-... in one plastic bag)

Customers use these products on PCB connected in series with parallel resistor  $R = 10\text{ M}\Omega$  across each IXBOD



# IXBOD 2 - Fast Break-Over Diodes

**Advantages** compared with IXBOD 1:

- Temperature coefficient  $K_T$  reduced by a factor of 3
  - tighter definition of the break-over voltage  $V_{BO}$ 
    - $V_{BO}(T_{VJ}) = V_{BO, 25^\circ C} [1 + K_T (T_{VJ} - 25^\circ C)]$
  - more precise and controllable design due to smaller tolerances
- Significant reduction of the switching-on time down to a few nanoseconds

**Applications:**

- Protection circuits for thyristors in high valuable designs
  - high DC current power transmissions for long distances like offshore windmills or hydroelectric dams
- High Intensity Discharge Lighting (HID)

## Fast Break-Over Diodes

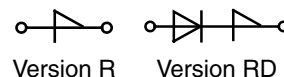

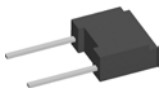
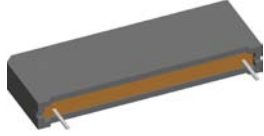
Type	$V_{BO}$ $T_{VJ} = 25^\circ C$ $K_T = 0.7 \cdot 10^{-3} K^{-1}$ V	$I_{BO}$ mA	$I_H$ $T_{VJ} = 25^\circ C$ mA	$V_H$ V	$I_D$ $T_{VJ} = 125^\circ C$ $V_D = 0.8 \cdot V_{BO}$ $\mu A$	$I_{AVM} \text{ ①}$ $T_{amb} = 50^\circ C$ A	$I_{SM}$ A	dv/dt V/ $\mu s$	$R_{thJA}$ K/W	Fig. No.	Package style Outline drawings on pages O-30...O-55
➤ <b>New</b>											
IXBOD 2-01	100	15	20	4-8	200	0.90	250	>1000	60	X201	X201 <b>FP-Case</b> (oil proof) 
IXBOD 2-02	200 $\pm 10\%$										
IXBOD 2-03	300 $\cdot V_{BO}$										
IXBOD 2-04	400										
IXBOD 2-05	500 $\pm 50$										
IXBOD 2-06	600										
IXBOD 2-07	700										
IXBOD 2-08	800										
IXBOD 2-09	900										
IXBOD 2-10	1000										
IXBOD 2-11	1100										
IXBOD 2-12	1200										
IXBOD 2-13	1300										
IXBOD 2-14	1400										
IXBOD 2-15R	1500 $\pm 50$	15	20	4-8	200	0.90	250	>1500	20	X202	X202 <b>BOD-Package</b> 
IXBOD 2-15RD											
IXBOD 2-16R	1600										
IXBOD 2-16RD											
IXBOD 2-17R	1700										
IXBOD 2-17RD											
IXBOD 2-18R	1800										
IXBOD 2-18RD											
IXBOD 2-19R	1900										
IXBOD 2-19RD											
IXBOD 2-20R	2000										
IXBOD 2-20RD											
IXBOD 2-21R	2100										
IXBOD 2-21RD											
IXBOD 2-22R	2200										
IXBOD 2-22RD											
IXBOD 2-23R	2300										
IXBOD 2-23RD											
IXBOD 2-24R	2400										
IXBOD 2-24RD											
IXBOD 2-25R	2500										
IXBOD 2-25RD											
IXBOD 2-26R	2600										
IXBOD 2-26RD											
IXBOD 2-27R	2700										
IXBOD 2-27RD											
IXBOD 2-28R	2800										
IXBOD 2-28RD											

# Fast Break-Over Diodes

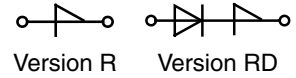

Type	$V_{BO}$ $T_{VJ} = 25\text{ °C}$ $K_T = 0.7 \cdot 10^{-3}\text{ K}^{-1}$ V	$I_{BO}$ mA	$I_H$ $T_{VJ} = 25\text{ °C}$ mA	$V_H$ V	$I_D$ $T_{VJ} = 125\text{ °C}$ $V_D = 0.8 \cdot V_{BO}$ $\mu\text{A}$	$I_{AVM}$ ① $T_{amb} = 50\text{ °C}$ A	$I_{SM}$ A	dv/dt V/ $\mu\text{s}$	$R_{thJA}$ K/W	Fig. No.	Package style Outline drawings on pages O-30...O-55
➤ New											
IXBOD 2-29R	2900 ±50	15	20	4-8	200	0.90	250	>2500	20	X202	<p>X202    <b>BOD-Package</b></p>
IXBOD 2-29RD											
IXBOD 2-30R	3000										
IXBOD 2-30RD											
IXBOD 2-31R	3100										
IXBOD 2-31RD											
IXBOD 2-32R	3200										
IXBOD 2-32RD											
IXBOD 2-33R	3300										
IXBOD 2-33RD											
IXBOD 2-34R	3400										
IXBOD 2-34RD											
IXBOD 2-35R	3500										
IXBOD 2-35RD											
IXBOD 2-36R	3600										
IXBOD 2-36RD											
IXBOD 2-37R	3700										
IXBOD 2-37RD											
IXBOD 2-38R	3800										
IXBOD 2-38RD											
IXBOD 2-39R	3900										
IXBOD 2-39RD											
IXBOD 2-40R	4000										
IXBOD 2-40RD											
IXBOD 2-41R	4100										
IXBOD 2-41RD											
IXBOD 2-42R	4200										
IXBOD 2-42RD											
IXBOD 2-43R	4300 ±50	15	20	4-8	200	0.90	250	>3500	20		
IXBOD 2-44R	4400										
IXBOD 2-45R	4500										
IXBOD 2-46R	4600										
IXBOD 2-47R	4700										
IXBOD 2-48R	4800										
IXBOD 2-49R	4900										
IXBOD 2-50R	5000										
IXBOD 2-51R	5100										
IXBOD 2-52R	5200										
IXBOD 2-53R	5300										
IXBOD 2-54R	5400										
IXBOD 2-55R	5500										
IXBOD 2-56R	5600										

① Leads soldered on PCB board,  $T_{slg}$  and  $T_{VJ} = -40 \dots +125\text{ °C}$

# Power Relays

For a complete listing of IXYS Integrated Circuits Division's Solid-State Relay products, please visit: [www.ixysic.com](http://www.ixysic.com)

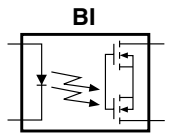

## 1-Form-A Relays: Single-Pole, Bidirectional

Part Number	Relay Type	Blocking Voltage (V <sub>P</sub> )	Load Current			On Resistance (Ω)	Input Control Current (mA)	Switching Speeds t <sub>on</sub> / t <sub>off</sub> (ms)	Isolation Voltage (V <sub>rms</sub> )	Off-State Leakage (μA)	Package Type
			Free Air (A <sub>rms</sub> )	5°C/W Heat Sink (A <sub>rms</sub> )	T <sub>C</sub> = 25°C (A <sub>rms</sub> )						
CPC1906Y	BI	60	2	-	-	0.3	10	10 / 5	2500	1	36
CPC1907B	BI	60	6	-	-	0.06	5	5 / 1	5000	1	66
CPC1908J	BI	60	3.5	8.5	15	0.3	10	20 / 5	2500	1	29
CPC1909J	BI	60	6.5	15	15	0.1	10	25 / 10	2500	1	37
CPC1916Y	BI	100	2.5	-	-	0.34	10	5 / 3	2500	1	36
CPC1918J	BI	100	5.25	13	15	0.1	10	25 / 10	2500	1	37
CPC1926Y	BI	250	0.7	-	-	1.4	10	10 / 10	2500	1	36
CPC1927J	BI	250	2.7	6.7	15	0.2	10	25 / 10	2500	1	37
CPC1967J	BI	400	1.35	3.35	13.15	0.85	10	20 / 5	2500	1	29
CPC1968J	BI	500	2	5	15	0.35	10	20 / 5	2500	1	37
CPC1973Y	BI	400	0.35	-	-	5	10	5 / 3	2500	1	36
CPC1977J	BI	600	1.25	3.1	12.25	1	10	20 / 5	2500	1	29
CPC1978J	BI	800	0.75	1.85	7.25	2.3	10	20 / 5	2500	1	29
CPC1979J	BI	600	1.4	3.5	14.5	0.75	10	25 / 5	2500	1	37
CPC1981Y	BI	1000	0.18	-	-	18	10	10 / 5	2500	1	36
CPC1983Y	BI	600	0.5	-	-	6	5	5 / 2	2500	1	36
CPC1983YE	BI	600	0.5	-	-	6	5	5 / 2	4000	1	36
CPC1986J	BI	1000	0.65	1.6	6.5	3	10	20 / 5	2500	1	29
CPC1988J	BI	1000	0.9	2.25	9.4	2.5	10	20 / 5	2500	1	37

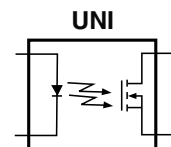

## 1-Form-A Relays: Single-Pole, Unidirectional

CPC1706Y	UNI	60	4	-	-	0.09	5	5 / 2	2500	1	36
CPC1708J	UNI	60	4	11.85	24	0.08	10	20 / 5	2500	1	29
CPC1709J	UNI	60	9	22.8	32	0.05	10	20 / 5	2500	1	37
CPC1718J	UNI	100	6.75	17.5	32	0.075	10	20 / 5	2500	1	37
CPC1726Y	UNI	250	1	-	-	0.75	10	5 / 2	2500	1	36
CPC1727J	UNI	250	3.4	8.6	20	0.09	10	20 / 5	2500	1	37
CPC1777J	UNI	600	1.5	4.6	15	0.5	10	20 / 5	2500	1	29
CPC1779J	UNI	600	1.65	4.12	15	0.4	10	20 / 5	2500	1	37
CPC1786J	UNI	1000	0.65	1.75	6.9	2	10	20 / 5	2500	1	29
CPC1788J	UNI	1000	1	2.45	10.3	1.25	10	20 / 5	2500	1	37

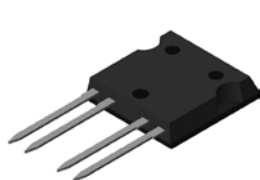

29

i4-PAC

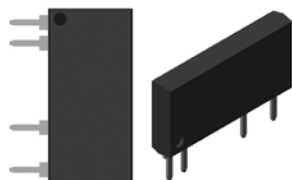

36

Power SIP

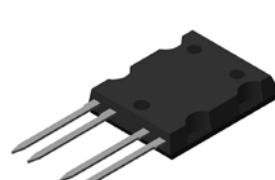

37

ISOPLUS-264



66



Power SOIC

# Optically Isolated AC Power Switches

These AC Power Switches offer dual power-SCR outputs, and have tightly controlled zero-cross circuitry to ensure switching of AC loads with minimal transient generation. These switches are ideal for controlling a variety of AC circuits in industrial environments where electromagnetic interference would disrupt the operation of electromechanical relays.

## AC Relays $I_{LOAD} > 1A$

Part Number	Blocking Voltage (V <sub>P</sub> )	Load Current			Input Control Current (mA)	Input Control Voltage (V)	Operating Frequency Min / Max (Hz)	Isolation Voltage (V <sub>rms</sub> )	Fig. No.
		No Heat Sink (A <sub>rms</sub> )	with 5°C/W Heat Sink (A <sub>rms</sub> )	T <sub>C</sub> = 25°C (A <sub>rms</sub> )					
➤ <b>New</b>									
<b>CPC1964B</b>	800	1.5	-	-	5	-	20 - 500	5000	66
<b>CPC1966</b>	600	3	-	-	5	-	20 - 500	3750	36
➤ <b>CPC1966B</b>	800	3	-	-	5	-	20 - 500	5000	66
<b>CPC1976</b>	600	2	-	-	5	-	20 - 500	3750	36
<b>CPC1998</b>	800	5	20	50	5	-	20 - 500	2500	29
➤ <b>CPC40055</b>	800	5	20	50	5	-	20 - 500	2500	64
➤ <b>CPC44055</b>	800	5	20	50	-	9 - 16	20 - 500	2500	64

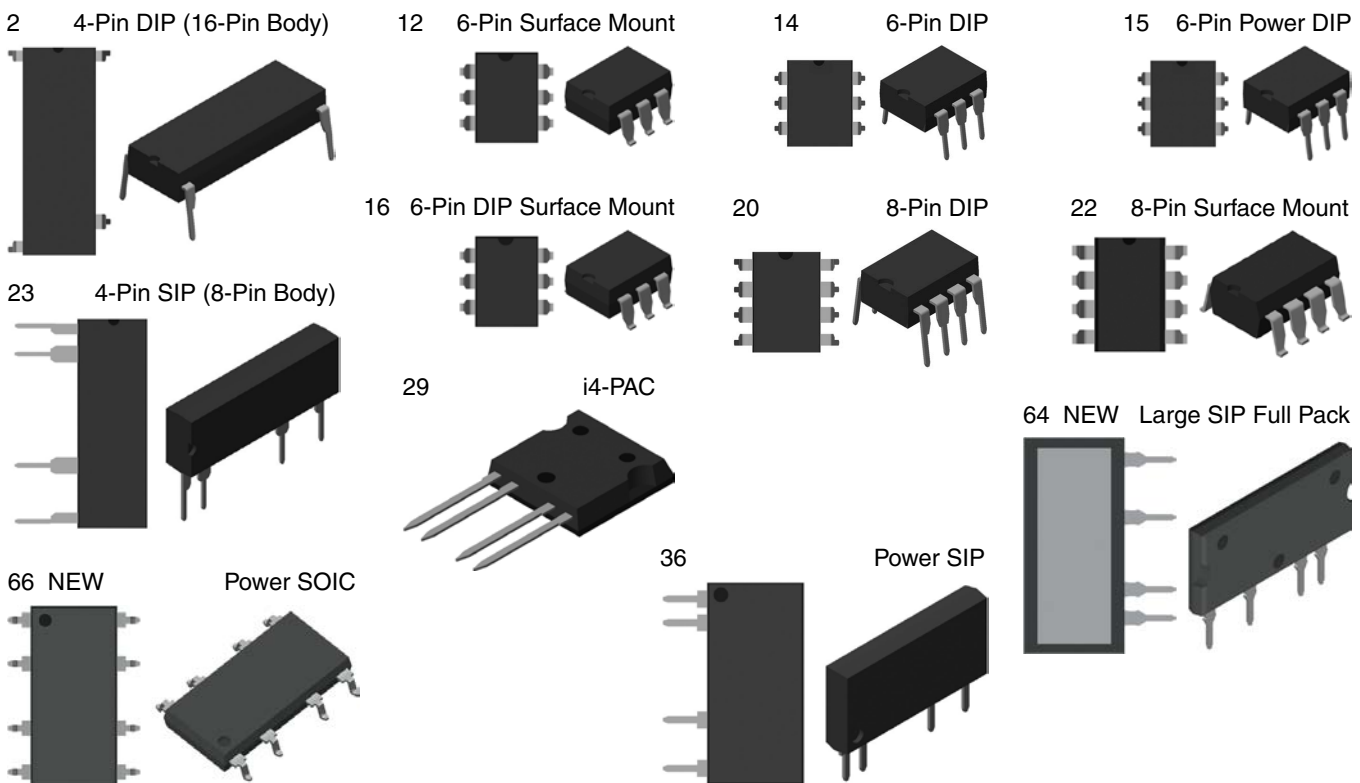



Part Number	Blocking Voltage (V <sub>P</sub> )	Load Current (A <sub>rms</sub> )	Input Control Current (mA)	Operating Frequency Min / Max (Hz)	Isolation Voltage (V <sub>rms</sub> )	Fig. No.
<b>CPC1943</b>	400	0.5	5	20 - 500	3750	15, 16
<b>CPC1945G</b>	400	1	5	20 - 400	3750	2
<b>CPC1945Y</b>	400	1	5	20 - 400	3750	23
<b>CPC1961</b>	600	0.25	5	20 - 500	3750	20, 22
<b>CPC1963</b>	600	0.5	5	20 - 500	3750	15, 16
<b>CPC1965G</b>	600	1	5	20 - 400	3750	2
<b>CPC1965Y</b>	600	1	5	20 - 400	3750	23
<b>CPC1972</b>	800	0.25	5	20 - 500	3750	12, 14
<b>PD1201</b>	400	1	5	20 - 500	3750	2
<b>PD2401</b>	500	1	5	20 - 500	3750	2
<b>PD2601</b>	600	1	5	20 - 500	3750	2
<b>PM1204</b>	400	0.5	5	20 - 500	3750	15, 16
<b>PM1205</b>	500	0.5	5	20 - 500	3750	15, 16
<b>PM1206</b>	600	0.5	5	20 - 500	3750	15, 16
<b>PS1201</b>	400	1	5	20 - 500	3750	23
<b>PS2401</b>	500	1	5	20 - 500	3750	23
<b>PS2601</b>	600	1	5	20 - 500	3750	23

For a complete listing of IXYS Integrated Circuits Division's Solid-State Relay products, please visit: [www.ixysic.com](http://www.ixysic.com)

# Gate Drivers

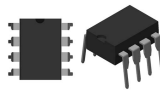
These ultra-fast, high current MOSFET and IGBT gate drivers are optimized for high efficiency performance in motor drive and power conversion applications. With output current ratings of 2A to 30A, they are designed to switch the largest MOSFETs and IGBTs with minimum switching times and at frequencies up to 10MHz. Depending on the output current rating, these gate drivers are offered in DFN, SOIC, Power SOIC, DIP, TO-220, and TO-263 packages.

Part Number	Output Type	$I_{PEAK}$ $T_C = 25^\circ C$ (A <sub>P</sub> )	Output Resistance ( $\Omega$ )	Logic Config.	Enable Function	Under-voltage Lockout (V)	Fig. No.	Package Type
IX4423	DUAL	3	4	D			54	20 <b>8-pin DIP</b> 
IX4424	DUAL	3	4	E		54		
IX4425	DUAL	3	4	F		54		
IX4426	DUAL	1.5	9	D		54, 56		
IX4427	DUAL	1.5	9	E		54, 56		
IX4428	DUAL	1.5	9	F		54, 56		
IXD_602	DUAL	2	4	D, E, F		20, 53, 54, 56		
IXD_604	DUAL	4	2.5	D, E, F, G	• (G)	20, 53, 54, 56	53 <b>8-pin Power SOIC</b> 	
IXD_609	SINGLE	9	1	A, B, C	• (A)	20, 53, 54, 56, 57, 58		
IXD_614	SINGLE	14	0.8	A, B, C	• (A)	20, 53, 57, 58		
IXD_630	SINGLE	30	0.4	A, B, C	• (A)	$V_{CC} \leq 12.5$ 57, 58		
IXD_630M	SINGLE	30	0.4	A, B, C	• (A)	$V_{CC} \leq 9$ 57, 58		

## IXD\_604SI/SIA and IXD\_609SI AEC Q100 Qualified!

54 **8-pin SOIC**  

56 **8-pin DFN**  

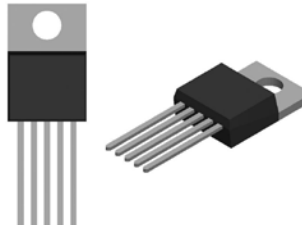
57 **5-pin TO-220**  

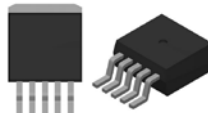
58 **5-pin TO-263**  

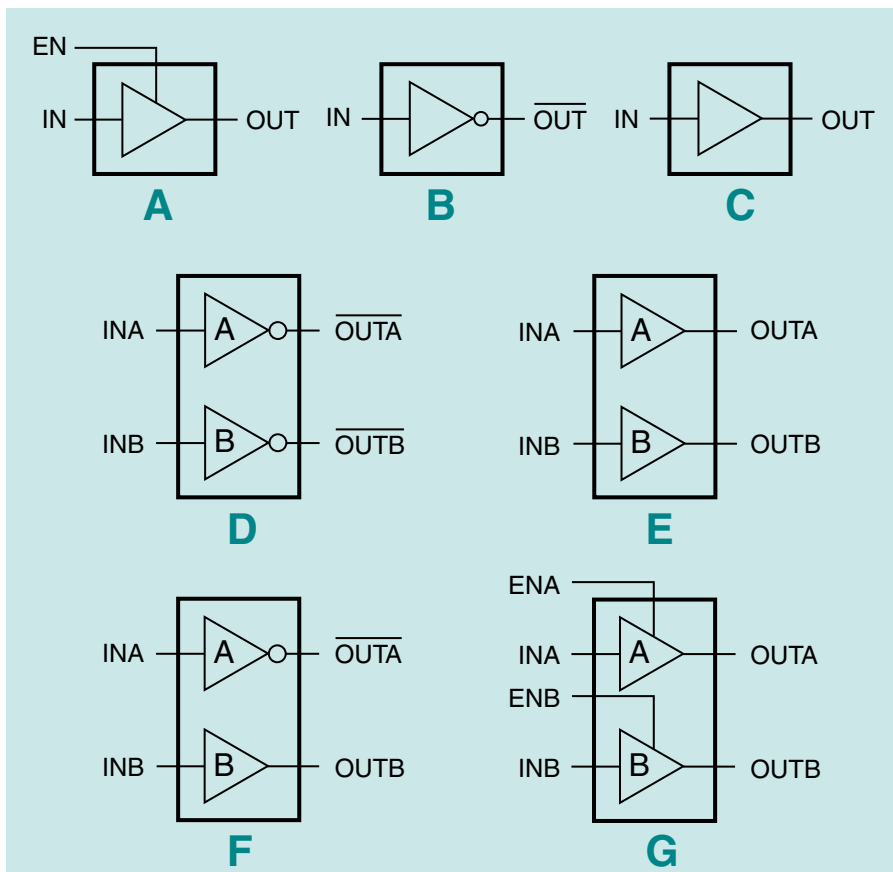

## IX2127 600V High-Side MOSFET and IGBT Gate Driver

The IX2127 is a high voltage, high-speed power MOSFET and IGBT driver. The device's high voltage level-shift technique enables it to operate at up to 600V. Proprietary common-mode design techniques provide stable operation in high dV/dt noise environments.

The IX2127 detects an over-current condition in the driven MOSFET or IGBT device, and shuts down drive to that device. An open-drain output, FAULT, indicates that an over-current shutdown has occurred. The gate driver output typically can source 250mA and sink 500mA, which is suitable for fluorescent lamp ballast, motor control, SMPS, and other converter drive topologies. Available in 8-pin DIP and 8-pin SOIC packages.

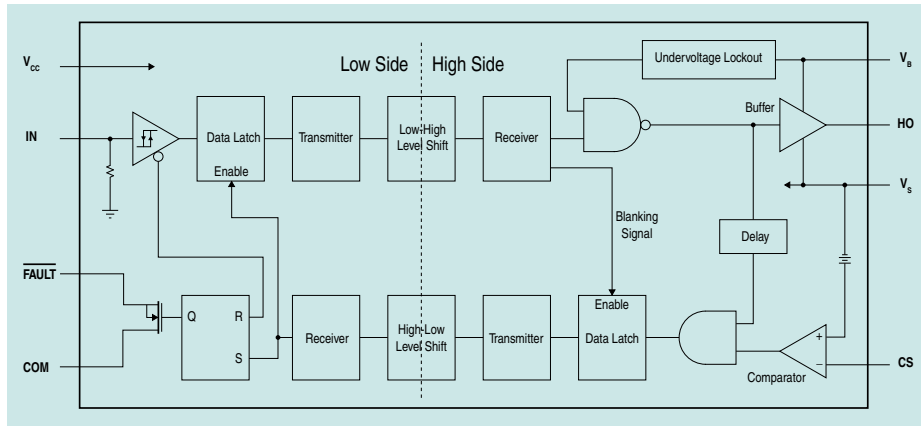

### Features:

- Floating Channel Designed for Bootstrap Operation up to 600V
- Tolerant to Negative Transient Voltages; dV/dt Immune
- Undervoltage Lockout
- 3.3V, 5V, and 12V Input Logic Compatible
- Open-Drain FAULT Indicator Pin Shows Over-Current Shutdown
- Output in Phase with the Input

### Applications:

- High Speed Gate Driver
- Motor Drive Inverter

8-pin DIP

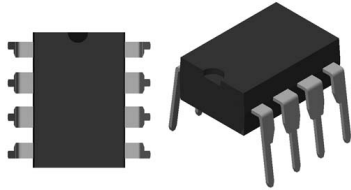

8-pin SOIC

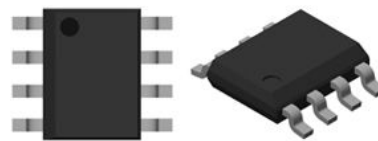

## IX3120 2.5A-Output Optically Coupled Gate Driver **NEW!**

The IX3120 gate driver includes an input infrared LED that is optically coupled to a power output stage. The power output stage is capable of sourcing or sinking 2.5A of peak current, which is ideal for driving IGBTs and MOSFETs in the mid-power range. The gate driver optocoupler with its low input LED current, high output peak current, and high noise immunity (25kV/μs) is ideally suited for use in motor control and inverter applications. The IX3120 is provided in an 8-pin DIP package and an 8-pin surface mount package.

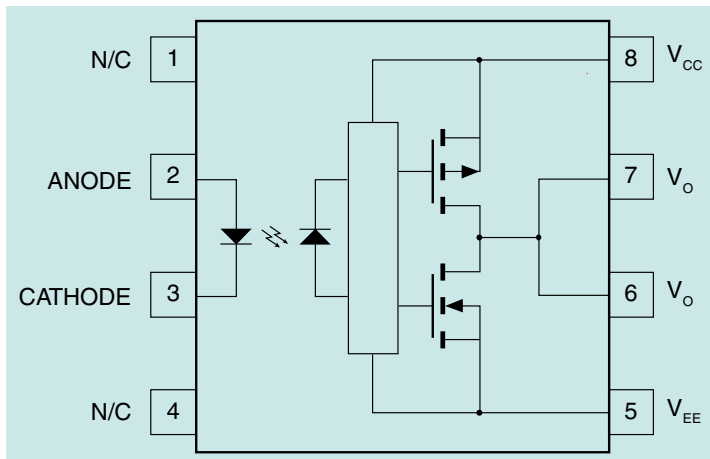

### Applications:

- Isolated IGBT/MOSFET Gate Drive
- Switch Mode Power Supplies
- Industrial Inverters
- Motor Drivers

### Features:

- 2.5A Maximum Peak Output Current
- 25kV/μs Minimum Common Mode Rejection (CMR) at 1500V<sub>CM</sub>
- Wide Operating Voltage Range: 15V to 30V
- Under Voltage Lockout with Hysteresis
- 3750V<sub>rms</sub> Input to Output Isolation
- Wide Temperature Range: -40°C to +100°C



# Gate Drivers

## Optically Isolated Gate Drivers

The CPC1580 and CPC1590 are high speed, optically isolated Gate Driver ICs. On-chip circuitry charges an external capacitor from the load voltage which eliminates the need for an external IC power supply. These Gate Drivers are ideal for low duty cycle switching applications. Both devices are provided in an 8-pin flatpack package.

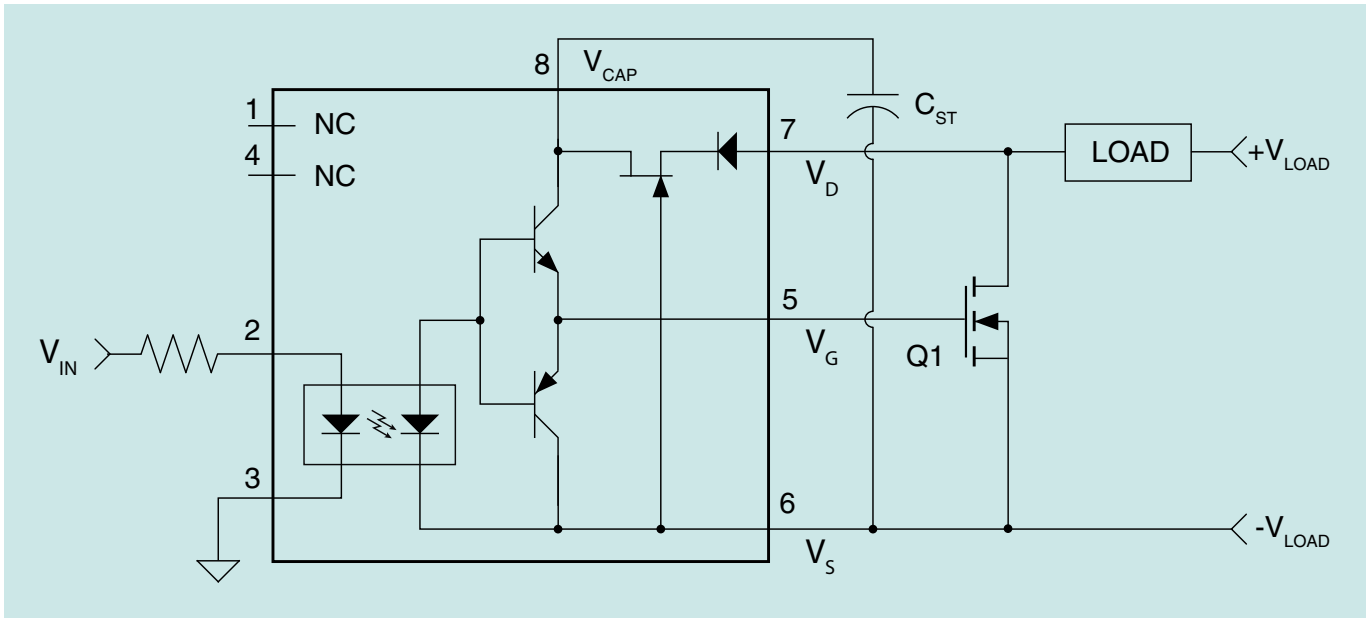

### Features:

- No External IC Power Supply
- Low Drive Power Requirements (TTL/CMOS Compatible)
- Load Voltages up to 200V
- Fast Switching Times - On: 40µsec / Off: 400µsec

### Applications:

- Instrumentation
- Multiplexers
- I/O Subsystems
- Meters (Watt-Hour, Water, Gas)
- Medical Equipment (Patient/Equipment Isolation)
- Industrial Controls
- Aerospace
- Security

8-Pin Flatpack

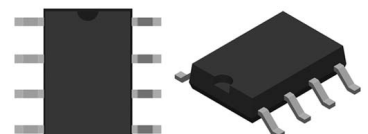

Part Number	Input Control Current (mA)	Gate Voltage	Blocking Voltage	Regulated Capacitor Voltage	Switching Speeds	Isolation Voltage
		@ I <sub>F</sub> = 5mA (V <sub>P</sub> )	(V <sub>P</sub> )	(V <sub>CAP-MAX</sub> )	t <sub>on</sub> / t <sub>off</sub> (µs)	(V <sub>rms</sub> )
CPC1580	2.5	7.5 - 12	65	V <sub>DS</sub> - 0.2V	40 / 400	3750
CPC1590	2.5	7.5 - 12	200	16	40 / 400	3750

For detailed catalog or data sheets go to [www.ixysic.com](http://www.ixysic.com)

# LED Drivers

## CPC9909 High Efficiency, High Brightness Off-Line LED Driver

The CPC9909 is a low-cost, high-efficiency, off-line, high-brightness (HB) LED driver manufactured using our high voltage BCDMOS on SOI process. It has an internal regulator that allows it to operate from 8VDC to 550VDC. This wide input operating voltage range enables the driver to be used in a broad range of HB LED applications.

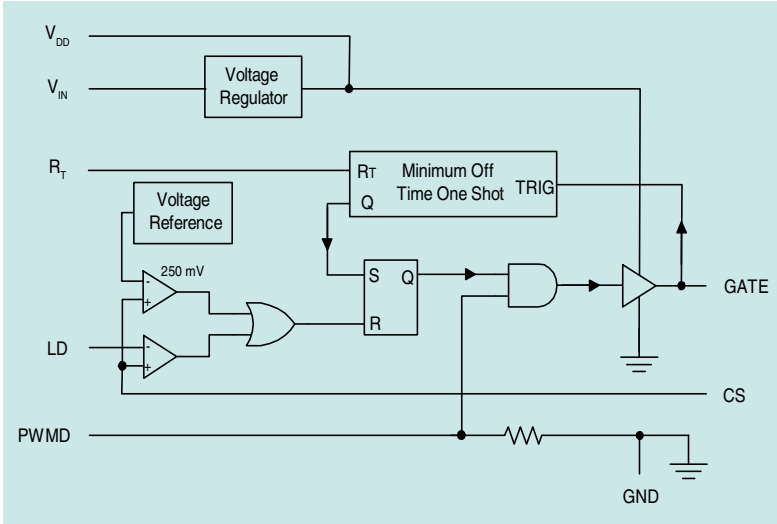

### Features:

- 8V to 550V Input Voltage Range
- >90% Efficiency
- Stable Operation at >50% Duty Cycle
- Drives Multiple LEDs in Series/Parallel
- Regulated LED Current
- Linear or PWM Brightness Control Inputs
- Resistor-Programmable Minimum Off-Time
- Buck or Boost Configuration
- Available in 8-Pin SOIC and Power SOIC Packages

8-Pin SOIC

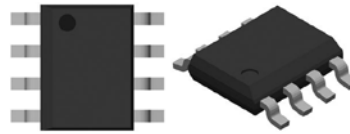

8-Pin Power SOIC

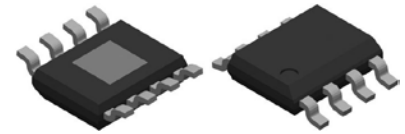

## MXHV9910 High Voltage, Off-Line LED Driver

The MXHV9910 features a fixed-frequency, peak-current control method, which provides an ideal solution for driving multiple LEDs in series and in parallel. Internal circuitry allows it to operate from a universal AC line, or from 8VDC to 450VDC. This highly versatile input operating voltage enables this IC to be used in a broad range of HB LED applications. In addition, LED dimming can be implemented by applying a small DC voltage to the LD pin, or by applying a low-frequency digital PWM signal to the PWMD pin. Applications include flat-panel display RGB backlighting, signage, decorative LED lighting, and DC & AC/DC LED driver applications.

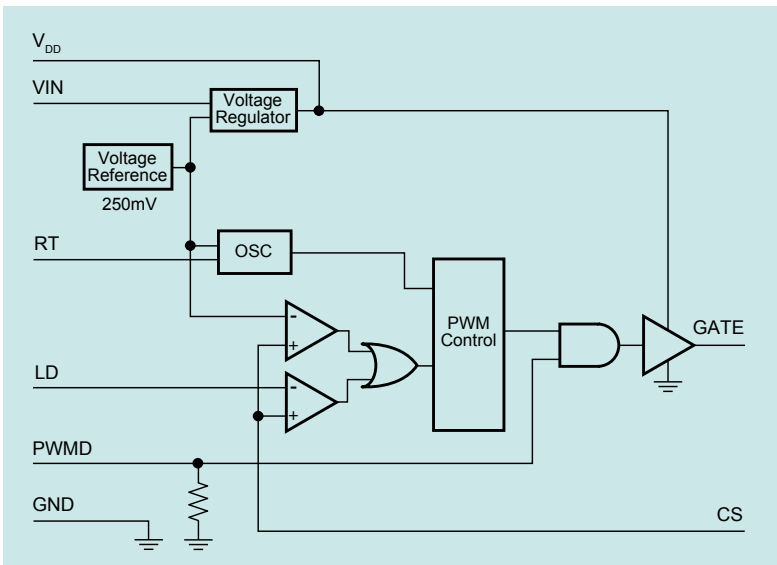

### Features:

- 8V to 450V Input Voltage Range
- >90% Efficiency
- Drives Multiple LEDs in Series/Parallel Combinations
- Regulated LED Drive Current
- Linear or PWM Brightness Control Inputs
- Resistor-Programmable Oscillator Frequency
- Available in 8-Pin SOIC and Power SOIC Packages

8-Pin SOIC

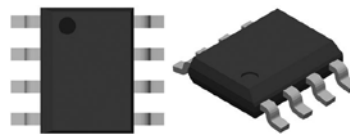

8-Pin Power SOIC

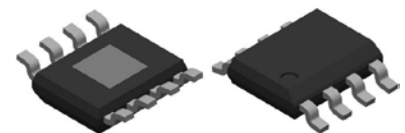



# Product Application Notes and Technical Information

Available from [www.ixysuk.com](http://www.ixysuk.com)

- Application dependent gate trigger requirements of GTO thyristors
- The implementation of gate turn-off thyristors as high voltage turn-on switches for pulse power applications
- Improved semiconductor switches for pulse power applications
- Integrated 30 kV Solid-State Switch for Pulse Power Applications
- Press-Pack IGBTs, Semiconductor Switches for Pulse Power
- The application of pressure contact IGBTs in pulse power
- Design concepts of a bondless pressure-contact IGBT
- Electromechanical characteristics of a bondless pressure contact IGBT
- Pressure Contacted IGBTs
- Pressure contact IGBT, the ideal switch for high power applications
- Pressure contact IGBT, testing for reliability
- New high current press-pack IGBTs
- Magazine Feature: Positive Development in high reliability completely bond free pressure contact IGBTs
- Application of Press-pack IGBTs in Traction Refurbishment
- New 5.2 kV Extra Fast Recovery Diodes for IGBT and IGCT Applications
- New family of 4.5 kV Press-Pack IGBTs
- New Extra Fast Soft Recovery Diodes and their Applications
- Managing power semiconductor obsolescence by press-pack IGBT substitution
- Westcode Product Nomenclatures (Capsules, Studs, and Pulse Thyristors)
- Terms & Symbols
- Mounting Instructions
- Press Releases

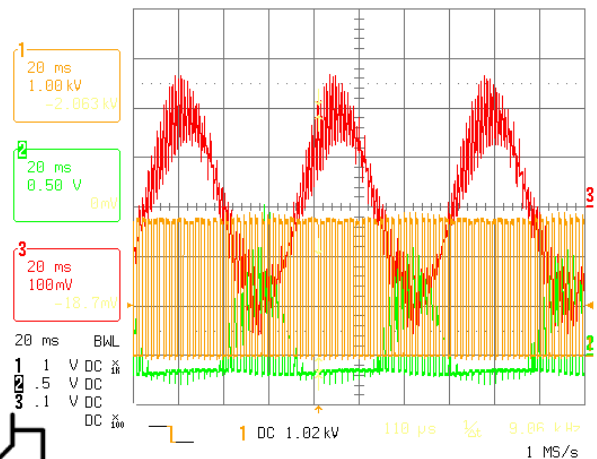
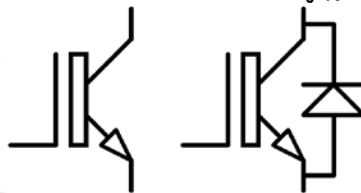





# Rectifier Diodes

Our comprehensive range of rectifier diodes offers class leading performance and reliability. Devices are available with blocking voltages from 200V up to 6kV. Optimised to offer low conduction losses, these devices are ideally suited to line frequency applications up to 400Hz including input rectifiers for variable speed drives, traction converters, trackside substations, welding and DC power supplies. Featuring compression bonded, alloyed Silicon wafer construction, these devices feature low thermal impedance and high overload capacity and are designed to survive even the most arduous applications.

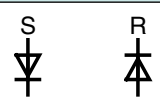







The latest additions to the IXYS UK Rectifier Diode family are four new 83mm dia Si Rectifier Diodes. These new designs use a bonded die construction and improved package design for maximum power to package ratio, as well as better thermal and electromechanical performance. Four new products have been launched offering average current ratings up to 9830A and voltage ratings up to 4800V with further products planned.

## Stud Types

Type Part No.	$V_{RRM}$ V	$I_{FAV}$ $T_C = 55^\circ\text{C}$ A	$I_{FSM}$ A	$I^2t$ 10 ms ½ sine $V_R \leq 60\% V_{RRM}$ A <sup>2</sup> s	$V_{T0}$ $r_T$ @ $T_{JM}$		$T_{JM}$ °C	$R_{thJC}$		Fig. No.	Package style Outlines on pages O-01...O-29
					V	mΩ		d.c. 180° sine K/W	120° Rect. K/W		
<b>W0428RE250</b>	2500	428	5500	$151 \times 10^3$	0.926	0.739	150	0.1300	0.1530	W39	
<b>W0428RE280</b>	2800	428	5500	$151 \times 10^3$	0.926	0.739	150	0.1300	0.1530	W39	
<b>W0428RE320</b>	3200	428	5500	$151 \times 10^3$	0.926	0.739	150	0.1300	0.1530	W39	
<b>W0428RF250</b>	2500	428	5500	$151 \times 10^3$	0.926	0.739	150	0.1300	0.1530	W24	
<b>W0428RF280</b>	2800	428	5500	$151 \times 10^3$	0.926	0.739	150	0.1300	0.1530	W24	
<b>W0428RF320</b>	3200	428	5500	$151 \times 10^3$	0.926	0.739	150	0.1300	0.1530	W24	
<b>W0428SE250</b>	2500	428	5500	$151 \times 10^3$	0.926	0.739	150	0.1300	0.1530	W39	
<b>W0428SE280</b>	2800	428	5500	$151 \times 10^3$	0.926	0.739	150	0.1300	0.1530	W39	
<b>W0428SE320</b>	3200	428	5500	$151 \times 10^3$	0.926	0.739	150	0.1300	0.1530	W39	
<b>W0428SF250</b>	2500	428	5500	$151 \times 10^3$	0.926	0.739	150	0.1300	0.1530	W24	
<b>W0428SF280</b>	2800	428	5500	$151 \times 10^3$	0.926	0.739	150	0.1300	0.1530	W24	
<b>W0428SF320</b>	3200	428	5500	$151 \times 10^3$	0.926	0.739	150	0.1300	0.1530	W24	
<b>W0503RC160</b>	1600	503	5500	$151 \times 10^3$	0.990	0.740	180	0.1300	0.1530	W24	
<b>W0503RC200</b>	2000	503	5500	$151 \times 10^3$	0.990	0.740	180	0.1300	0.1530	W24	
<b>W0503RC240</b>	2400	503	5500	$151 \times 10^3$	0.990	0.740	180	0.1300	0.1530	W24	
<b>W0503SC160</b>	1600	503	5500	$151 \times 10^3$	0.990	0.740	180	0.1300	0.1530	W24	
<b>W0503SC200</b>	2000	503	5500	$151 \times 10^3$	0.990	0.740	180	0.1300	0.1530	W24	
<b>W0503SC240</b>	2400	503	5500	$151 \times 10^3$	0.990	0.740	180	0.1300	0.1530	W24	
<b>W0735RA120</b>	1200	735	9000	$405 \times 10^3$	0.790	0.342	190	0.1300	0.1530	W23	
<b>W0735RA150</b>	1500	735	9000	$405 \times 10^3$	0.790	0.342	190	0.1300	0.1530	W23	
<b>W0735SA120</b>	1200	735	9000	$405 \times 10^3$	0.790	0.342	190	0.1300	0.1530	W23	
<b>W0735SA150</b>	1500	735	9000	$405 \times 10^3$	0.790	0.342	190	0.1300	0.1530	W23	













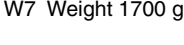
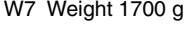

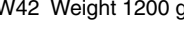

# Rectifier Diodes

## Capsule Types

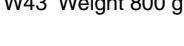
Type Part No. ○ Not for new design ➤ New	V <sub>RRM</sub> V	I <sub>FAV</sub> T <sub>K</sub> = 55°C A	I <sub>FSM</sub> 10 ms ½ sine V <sub>R</sub> ≤ 60% V <sub>RRM</sub> A	I <sup>2</sup> t A <sup>2</sup> s	V <sub>TO</sub> r <sub>T</sub> @ T <sub>JM</sub>		T <sub>JM</sub> °C	R <sub>thJK</sub>		Fig. No.	Package style Outlines on pages O-01...O-29
					V	mΩ		180° Sine K/W	120° Rect. K/W		
W0507YH360	3600	507	7600	289 x 10 <sup>3</sup>	0.970	0.880	160	0.1000	0.1170	W3	
W0507YH450	4500	507	7600	289 x 10 <sup>3</sup>	0.970	0.880	160	0.1000	0.1170	W3	
W0642WC160	1600	642	5500	151 x 10 <sup>3</sup>	0.990	0.740	180	0.0900	0.0980	W1	
W0642WC200	2000	642	5500	151 x 10 <sup>3</sup>	0.990	0.740	180	0.0900	0.0980	W1	
W0642WC240	2400	642	5500	151 x 10 <sup>3</sup>	0.990	0.740	180	0.0900	0.0980	W1	
W0944WC120	1200	944	9000	405 x 10 <sup>3</sup>	0.790	0.342	190	0.0900	0.0980	W1	
W0944WC150	1500	944	9000	405 x 10 <sup>3</sup>	0.790	0.342	190	0.0900	0.0980	W1	
W1032LC500	5000	1032	7200	259 x 10 <sup>3</sup>	1.000	0.702	150	0.0330	0.0400	W4	W1 Weight 70 g
W1032LC560	5600	1032	7200	259 x 10 <sup>3</sup>	1.000	0.702	150	0.0330	0.0400	W4	
W1032LC600	6000	1032	7200	259 x 10 <sup>3</sup>	1.000	0.702	150	0.0330	0.0400	W4	
W1074YC200	2000	1074	10800	583 x 10 <sup>3</sup>	0.920	0.390	160	0.0500	0.0610	W2	
W1074YC260	2600	1074	10800	583 x 10 <sup>3</sup>	0.920	0.390	160	0.0500	0.0610	W2	
W1074YC320	3200	1074	10800	583 x 10 <sup>3</sup>	0.920	0.390	160	0.0500	0.0610	W2	
W1074YH200	2000	1074	10800	583 x 10 <sup>3</sup>	0.920	0.390	160	0.0500	0.0610	W3	
W1074YH260	2600	1074	10800	583 x 10 <sup>3</sup>	0.920	0.390	160	0.0500	0.0610	W3	
W1074YH320	3200	1074	10800	583 x 10 <sup>3</sup>	0.920	0.390	160	0.0500	0.0610	W3	
W1185LC300	3000	1185	9200	423 x 10 <sup>3</sup>	1.000	0.575	160	0.0330	0.0400	W4	W2 Weight 80 g
W1185LC380	3800	1185	9200	423 x 10 <sup>3</sup>	1.000	0.575	160	0.0330	0.0400	W4	
W1185LC450	4500	1185	9200	423 x 10 <sup>3</sup>	1.000	0.575	160	0.0330	0.0400	W4	
W1263YC160	1600	1263	11700	684 x 10 <sup>3</sup>	0.870	0.330	175	0.0500	0.0610	W2	
W1263YC200	2000	1263	11700	684 x 10 <sup>3</sup>	0.870	0.330	175	0.0500	0.0610	W2	
W1263YC250	2500	1263	11700	684 x 10 <sup>3</sup>	0.870	0.330	175	0.0500	0.0610	W2	
W1263YH160	1600	1263	11700	684 x 10 <sup>3</sup>	0.870	0.330	175	0.0500	0.0610	W3	
W1263YH200	2000	1263	11700	684 x 10 <sup>3</sup>	0.870	0.330	175	0.0500	0.0610	W3	
W1263YH250	2500	1263	11700	684 x 10 <sup>3</sup>	0.870	0.330	175	0.0500	0.0610	W3	
W1411LC300	3000	1411	10600	562 x 10 <sup>3</sup>	0.900	0.388	160	0.0330	0.0400	W4	W3 Weight 140 g
W1411LC360	3600	1411	10600	562 x 10 <sup>3</sup>	0.900	0.388	160	0.0330	0.0400	W4	
W1520NC500	5000	1478	12000	720 x 10 <sup>3</sup>	0.904	0.552	150	0.0220	0.0255	W5	
W1520NC600	6000	1478	12000	720 x 10 <sup>3</sup>	0.904	0.552	150	0.0220	0.0255	W5	
W1524LC240	2400	1524	12700	810 x 10 <sup>3</sup>	0.870	0.323	160	0.0330	0.0400	W4	
W1524LC300	3000	1524	12700	810 x 10 <sup>3</sup>	0.870	0.323	160	0.0330	0.0400	W4	
W1748LC180	1800	1748	15400	1.19 x 10 <sup>6</sup>	0.870	0.280	175	0.0330	0.0400	W4	
W1748LC220	2200	1748	15400	1.19 x 10 <sup>6</sup>	0.870	0.280	175	0.0330	0.0400	W4	
W1748LC250	2500	1748	15400	1.19 x 10 <sup>6</sup>	0.870	0.280	175	0.0330	0.0400	W4	
○ W1856NC400	4000	1856	16000	1.28 x 10 <sup>6</sup>	0.975	0.348	160	0.0220	0.0255	W5	
○ W1856NC500	5000	1856	16000	1.28 x 10 <sup>6</sup>	0.975	0.348	160	0.0220	0.0255	W5	
W2054NC360	3600	2054	19000	1.81 x 10 <sup>6</sup>	0.800	0.300	160	0.0220	0.0255	W5	
W2054NC450	4500	2054	19000	1.81 x 10 <sup>6</sup>	0.800	0.300	160	0.0220	0.0255	W5	
W2058LC100	1000	2058	19500	1.90 x 10 <sup>6</sup>	0.790	0.192	175	0.0330	0.0400	W4	W4 Weight 340 g
W2058LC120	1200	2058	19500	1.90 x 10 <sup>6</sup>	0.790	0.192	175	0.0330	0.0400	W4	
W2058LC140	1400	2058	19500	1.90 x 10 <sup>6</sup>	0.790	0.192	175	0.0330	0.0400	W4	
W2115MC520	5200	2122	19000	1.81 x 10 <sup>6</sup>	1.074	0.405	150	0.0140	0.0160	W54	
W2115MC560	5600	2122	19000	1.81 x 10 <sup>6</sup>	1.074	0.405	150	0.0140	0.0160	W54	
W2115MC600	6000	2122	19000	1.81 x 10 <sup>6</sup>	1.074	0.405	150	0.0140	0.0160	W54	
W2134NC300	3000	2134	20000	2.00 x 10 <sup>6</sup>	0.865	0.260	160	0.0220	0.0255	W5	W5 Weight 510 g
W2134NC400	4000	2134	20000	2.00 x 10 <sup>6</sup>	0.865	0.260	160	0.0220	0.0255	W5	
○ W2624NC200	2000	2624	28000	3.92 x 10 <sup>6</sup>	0.780	0.160	160	0.0220	0.0255	W5	
○ W2624NC250	2500	2624	28000	3.92 x 10 <sup>6</sup>	0.780	0.160	160	0.0220	0.0255	W5	
W2820VC360	3600	2820	26200	3.43 x 10 <sup>6</sup>	1.300	0.147	160	0.0160	0.0180	W6	
W2820VC450	4500	2820	26200	3.43 x 10 <sup>6</sup>	1.300	0.147	160	0.0160	0.0180	W6	
W2820VF360	3600	2820	26200	3.43 x 10 <sup>6</sup>	1.300	0.147	160	0.0160	0.0180	W43	
W2820VF450	4500	2820	26200	3.43 x 10 <sup>6</sup>	1.300	0.147	160	0.0160	0.0180	W43	
W2899MC420	4200	2899	25400	3.23 x 10 <sup>6</sup>	0.996	0.222	160	0.0140	0.0160	W54	W54 Weight 1000 g
W2899MC460	4600	2899	25400	3.23 x 10 <sup>6</sup>	0.996	0.222	160	0.0140	0.0160	W54	
W2899MC480	4800	2899	25400	3.23 x 10 <sup>6</sup>	0.996	0.222	160	0.0140	0.0160	W54	
W3082MC420	4200	3120	26000	3.38 x 10 <sup>6</sup>	0.923	0.192	160	0.0140	0.0160	W54	W54 Weight 1000 g
W3082MC440	4400	3120	26000	3.38 x 10 <sup>6</sup>	0.923	0.192	160	0.0140	0.0160	W54	
W3082MC450	4500	3120	26000	3.38 x 10 <sup>6</sup>	0.923	0.192	160	0.0140	0.0160	W54	















# Rectifier Diodes

## Capsule Types

Type Part No. ○ Not for new design ➤ New	V <sub>RRM</sub> V	I <sub>FAV</sub> T <sub>K</sub> = 55°C A	I <sub>FSM</sub> 10 ms ½ sine V <sub>R</sub> ≤ 60% V <sub>RRM</sub>		V <sub>T0</sub> V	r <sub>T</sub> mΩ @T <sub>JM</sub>	T <sub>JM</sub> °C	R <sub>thJK</sub>		Fig. No.	Package style Outlines on pages O-01...O-29
			A	A <sup>2</sup> s				180° Sine K/W	120° Rect. K/W		
W3128VC300	3000	3128	30000	4.50 x 10 <sup>6</sup>	0.875	0.158	160	0.0160	0.0190	W6	
W3128VC400	4000	3128	30000	4.50 x 10 <sup>6</sup>	0.875	0.158	160	0.0160	0.0190	W6	
W3128VF300	3000	3128	30000	4.50 x 10 <sup>6</sup>	0.875	0.158	160	0.0160	0.0190	W43	
W3128VF400	4000	3128	30000	4.50 x 10 <sup>6</sup>	0.875	0.158	160	0.0160	0.0190	W43	
W3270NC20A †	2000	3270	30400	4.62 x 10 <sup>6</sup>	0.826	0.104	175	0.0220	0.0260	W5	
W3270NC22A †	2200	3270	30400	4.62 x 10 <sup>6</sup>	0.826	0.104	175	0.0220	0.0260	W5	
W3270NC200 ‡	2000	3270	30400	4.62 x 10 <sup>6</sup>	0.826	0.104	175	0.0220	0.0260	W5	
W3270NC220 ‡	2200	3270	30400	4.62 x 10 <sup>6</sup>	0.826	0.104	175	0.0220	0.0260	W5	
➤ W3305QK240	2400	3305	18500	1.71 x 10 <sup>6</sup>	0.910	0.150	175	0.0170	0.0207	WD2	
➤ W3305QK280	2800	3305	18500	1.71 x 10 <sup>6</sup>	0.910	0.150	175	0.0170	0.0207	WD2	
W3455QK200	2000	3455	20000	2.00 x 10 <sup>6</sup>	0.940	0.139	180	0.0170	0.0207	WD2	
W3455QK220	2200	3455	20000	2.00 x 10 <sup>6</sup>	0.940	0.139	180	0.0170	0.0207	WD2	
W3477MC360	3600	3470	28200	3.98 x 10 <sup>6</sup>	0.908	0.146	160	0.0140	0.0160	W54	
W3477MC380	3800	3470	28200	3.98 x 10 <sup>6</sup>	0.958	0.146	160	0.0140	0.0160	W54	
W3477MC400	4000	3470	28200	3.98 x 10 <sup>6</sup>	0.958	0.146	160	0.0140	0.0160	W54	
W3697VC220	2200	3697	40000	8.00 x 10 <sup>6</sup>	0.860	0.100	160	0.0160	0.0190	W6	
W3697VC280	2800	3697	40000	8.00 x 10 <sup>6</sup>	0.860	0.100	160	0.0160	0.0190	W6	
W3697VF220	2200	3697	40000	8.00 x 10 <sup>6</sup>	0.860	0.100	160	0.0160	0.0190	W43	
W3697VF280	2800	3697	40000	8.00 x 10 <sup>6</sup>	0.860	0.100	160	0.0160	0.0190	W43	
W3708MC300	3000	3753	30000	4.50 x 10 <sup>6</sup>	0.958	0.112	160	0.0140	0.0160	W54	
W3708MC320	3200	3753	30000	4.50 x 10 <sup>6</sup>	0.958	0.112	160	0.0140	0.0160	W54	
W3708MC350	3500	3753	30000	4.50 x 10 <sup>6</sup>	0.958	0.112	160	0.0140	0.0160	W54	
W3743ZC400	4000	3743	35000	6.13 x 10 <sup>6</sup>	0.976	0.170	160	0.0110	0.0132	W7	
W3743ZC450	4500	3743	35000	6.13 x 10 <sup>6</sup>	0.976	0.170	160	0.0110	0.0132	W7	
W3743ZC500	5000	3743	35000	6.13 x 10 <sup>6</sup>	0.976	0.170	160	0.0110	0.0132	W7	
W3743ZD400	4000	3743	35000	6.13 x 10 <sup>6</sup>	0.976	0.170	160	0.0110	0.0132	W42	
W3743ZD450	4500	3743	35000	6.13 x 10 <sup>6</sup>	0.976	0.170	160	0.0110	0.0132	W42	
W3743ZD500	5000	3743	35000	6.13 x 10 <sup>6</sup>	0.976	0.170	160	0.0110	0.0132	W42	
W3841VC300	3000	3841	39800	7.92 x 10 <sup>6</sup>	0.860	0.115	175	0.0160	0.0190	W6	
W3841VC340	3400	3841	39800	7.92 x 10 <sup>6</sup>	0.860	0.115	175	0.0160	0.0190	W6	
W3841VF300	3000	3841	39800	7.92 x 10 <sup>6</sup>	0.860	0.115	175	0.0160	0.0190	W43	
W3841VF340	3400	3841	39800	7.92 x 10 <sup>6</sup>	0.860	0.115	175	0.0160	0.0190	W43	
W3842MC240	2400	3842	35100	6.16 x 10 <sup>6</sup>	0.831	0.118	160	0.0140	0.0160	W54	
W3842MC280	2800	3842	35100	6.16 x 10 <sup>6</sup>	0.831	0.118	160	0.0140	0.0160	W54	
W3864QK120	1200	3864	22200	2.46 x 10 <sup>6</sup>	0.861	0.109	180	0.0170	0.0210	WD2	
W3864QK150	1500	3864	22200	2.46 x 10 <sup>6</sup>	0.861	0.109	180	0.0170	0.0210	WD2	
W3864QK180	1800	3864	22200	2.46 x 10 <sup>6</sup>	0.861	0.109	180	0.0170	0.0210	WD2	
W4096ZC340	3400	4096	41700	8.70 x 10 <sup>6</sup>	0.730	0.158	160	0.0110	0.0132	W7	
W4096ZC450	4500	4096	41700	8.70 x 10 <sup>6</sup>	0.730	0.158	160	0.0110	0.0132	W7	
W4096ZD340	3400	4096	41700	8.70 x 10 <sup>6</sup>	0.730	0.158	160	0.0110	0.0132	W42	
W4096ZD450	4500	4096	41700	8.70 x 10 <sup>6</sup>	0.730	0.158	160	0.0110	0.0132	W42	
W4534NC020	200	4543	40000	8.00 x 10 <sup>6</sup>	0.765	0.052	190	0.0220	0.0260	W5	
W4534NC060	600	4543	40000	8.00 x 10 <sup>6</sup>	0.765	0.052	190	0.0220	0.0260	W5	
W4693QK050	500	4693	31500	4.98 x 10 <sup>6</sup>	0.904	0.057	180	0.0170	0.0207	WD2	
W4693QK080	800	4693	31500	4.98 x 10 <sup>6</sup>	0.904	0.057	180	0.0170	0.0207	WD2	
W4693QR050	500	4693	31500	4.98 x 10 <sup>6</sup>	0.904	0.057	180	0.0170	0.0207	WD7	
W4693QR080	800	4693	31500	4.98 x 10 <sup>6</sup>	0.904	0.057	180	0.0170	0.0207	WD7	
W4713HL300	3000	4713	56000	15.70 x 10 <sup>6</sup>	0.807	0.090	160	0.0120	0.0132	WD5	
W4713HL350	3500	4713	56000	15.70 x 10 <sup>6</sup>	0.807	0.090	160	0.0120	0.0132	WD5	
W4713HM300	3000	4713	56000	15.70 x 10 <sup>6</sup>	0.807	0.090	160	0.0120	0.0132	WD6	
W4713HM350	3500	4713	56000	15.70 x 10 <sup>6</sup>	0.807	0.090	160	0.0120	0.0132	WD6	
W4767MC180	1800	4767	38000	7.22 x 10 <sup>6</sup>	0.819	0.083	175	0.0140	0.0160	W54	
W4767MC220	2200	4767	38000	7.22 x 10 <sup>6</sup>	0.819	0.083	175	0.0140	0.0160	W54	
W5092ZC320	3200	5092	58000	16.8 x 10 <sup>6</sup>	0.874	0.079	160	0.0110	0.0132	W7	
W5092ZC350	3500	5092	58000	16.8 x 10 <sup>6</sup>	0.874	0.079	160	0.0110	0.0132	W7	
W5092ZD320	3200	5092	58000	16.8 x 10 <sup>6</sup>	0.874	0.079	160	0.0110	0.0132	W42	
W5092ZD350	3500	5092	58000	16.8 x 10 <sup>6</sup>	0.874	0.079	160	0.0110	0.0132	W42	
➤ W5130MK240	2400	5130	42000	8.82 x 10 <sup>6</sup>	0.910	0.070	175	0.0130	0.0149	WD3	
➤ W5130MK280	2800	5130	42000	8.82 x 10 <sup>6</sup>	0.910	0.070	175	0.0130	0.0149	WD3	

# Rectifier Diodes

## Capsule Types

Type Part No. ○ Not for new design ➤ New	V <sub>RRM</sub> V	I <sub>FAV</sub> T <sub>K</sub> = 55°C A	I <sub>FSM</sub> 10 ms ½ sine V <sub>R</sub> ≤ 60% V <sub>RRM</sub> A	I <sup>2</sup> t A <sup>2</sup> s	V <sub>TO</sub> r <sub>T</sub> @ T <sub>JM</sub>		T <sub>JM</sub> °C	R <sub>thJK</sub>		Fig. No.	Package style Outlines on pages O-01...O-29
					V	mΩ		180° Sine K/W	120° Rect. K/W		
➤ W5139TJ400	4000	5139	55000	15.10 x 10 <sup>6</sup>	0.826	0.136	160	0.0080	0.0085	W89	 
➤ W5139TJ480	4800	5139	55000	15.10 x 10 <sup>6</sup>	0.826	0.136	160	0.0080	0.0085	W89	
➤ W5139TE400	4000	5139	55000	15.10 x 10 <sup>6</sup>	0.826	0.136	160	0.0080	0.0085	W94	
➤ W5139TE480	4800	5139	55000	15.10 x 10 <sup>6</sup>	0.826	0.136	160	0.0080	0.0085	W94	
W5282ZC240	2400	5282	60000	18.00 x 10 <sup>6</sup>	0.970	0.064	160	0.0110	0.0132	W7	
W5282ZC300	3000	5282	60000	18.00 x 10 <sup>6</sup>	0.970	0.064	160	0.0110	0.0132	W7	
W5282ZD240	2400	5282	60000	18.00 x 10 <sup>6</sup>	0.970	0.064	160	0.0110	0.0132	W42	
W5282ZD300	3000	5282	60000	18.00 x 10 <sup>6</sup>	0.970	0.064	160	0.0110	0.0132	W42	
○ W5292TC500	5000	5292	52700	13.90 x 10 <sup>6</sup>	1.027	0.111	160	0.0080	0.0085	W28	
○ W5292TC560	5600	5292	52700	13.90 x 10 <sup>6</sup>	1.027	0.111	160	0.0080	0.0085	W28	
○ W5292TD500	5000	5292	52700	13.90 x 10 <sup>6</sup>	1.027	0.111	160	0.0080	0.0085	W29	
○ W5292TD560	5600	5292	52700	13.90 x 10 <sup>6</sup>	1.027	0.111	160	0.0080	0.0085	W29	
W5334MK200	2000	5334	46800	10.95 x 10 <sup>6</sup>	0.892	0.069	180	0.0130	0.0149	WD3	
W5334MK220	2200	5334	46800	10.95 x 10 <sup>6</sup>	0.892	0.069	180	0.0130	0.0149	WD3	
W5636MC120	1200	5636	46000	10.58 x 10 <sup>6</sup>	0.698	0.059	175	0.0140	0.0160	W54	
W5636MC140	1400	5636	46000	10.58 x 10 <sup>6</sup>	0.698	0.059	175	0.0140	0.0160	W54	
W5636MC150	1500	5636	46000	10.58 x 10 <sup>6</sup>	0.698	0.059	175	0.0140	0.0160	W54	
W5696VC100	1000	5696	53000	14.00 x 10 <sup>6</sup>	0.650	0.059	190	0.0160	0.0190	W6	
W5696VC140	1400	5696	53000	14.00 x 10 <sup>6</sup>	0.650	0.059	190	0.0160	0.0190	W6	
W5696VF100	1000	5696	53000	14.00 x 10 <sup>6</sup>	0.650	0.059	190	0.0160	0.0190	W43	
W5696VF140	1400	5696	53000	14.00 x 10 <sup>6</sup>	0.650	0.059	190	0.0160	0.0190	W43	
W5838ZC180	1800	5838	64000	20.50 x 10 <sup>6</sup>	0.800	0.074	175	0.0110	0.0132	W7	
W5838ZC220	2200	5838	64000	20.50 x 10 <sup>6</sup>	0.800	0.074	175	0.0110	0.0132	W7	
W5838ZD180	1800	5838	64000	20.50 x 10 <sup>6</sup>	0.800	0.074	175	0.0110	0.0132	W42	
W5838ZD220	2200	5838	64000	20.50 x 10 <sup>6</sup>	0.800	0.074	175	0.0110	0.0132	W42	
➤ W5984TJ360	3600	5984	62000	19.20 x 10 <sup>6</sup>	0.758	0.097	160	0.0080	0.0085	W89	
➤ W5984TJ400	4000	5984	62000	19.20 x 10 <sup>6</sup>	0.758	0.097	160	0.0080	0.0085	W89	
➤ W5984TE360	3600	5984	62000	19.20 x 10 <sup>6</sup>	0.758	0.097	160	0.0080	0.0085	W94	
➤ W5984TE400	4000	5984	62000	19.20 x 10 <sup>6</sup>	0.758	0.097	160	0.0080	0.0085	W94	
W6262ZC200	2000	6262	67000	22.40 x 10 <sup>6</sup>	0.740	0.065	175	0.0110	0.0132	W7	
W6262ZC240	2400	6262	67000	22.40 x 10 <sup>6</sup>	0.740	0.065	175	0.0110	0.0132	W7	
W6262ZD200	2000	6262	67000	22.40 x 10 <sup>6</sup>	0.740	0.065	175	0.0110	0.0132	W42	
W6262ZD240	2400	6262	67000	22.40 x 10 <sup>6</sup>	0.740	0.065	175	0.0110	0.0132	W42	
W6908FC450	4500	6908	70000	24.50 x 10 <sup>6</sup>	0.767	0.092	160	0.0065	0.0069	W52	
W6908FC500	5000	6908	70000	24.50 x 10 <sup>6</sup>	0.767	0.092	160	0.0065	0.0069	W52	
W6908FD450	4500	6908	70000	24.50 x 10 <sup>6</sup>	0.767	0.092	160	0.0065	0.0069	W59	
W6908FD500	5000	6908	70000	24.50 x 10 <sup>6</sup>	0.767	0.092	160	0.0065	0.0069	W59	
W7045MC030	300	7045	54000	14.60 x 10 <sup>6</sup>	0.793	0.033	190	0.0140	0.0160	W54	
W7045MC060	600	7045	54000	14.60 x 10 <sup>6</sup>	0.793	0.033	190	0.0140	0.0160	W54	
W8405ZC100	1000	8405	72000	25.90 x 10 <sup>6</sup>	0.670	0.038	190	0.0110	0.0132	W7	
W8405ZC140	1400	8405	72000	25.90 x 10 <sup>6</sup>	0.670	0.038	190	0.0110	0.0132	W7	
W8405ZD100	1000	8405	72000	25.90 x 10 <sup>6</sup>	0.670	0.038	190	0.0110	0.0132	W42	
W8405ZD140	1400	8405	72000	25.90 x 10 <sup>6</sup>	0.670	0.038	190	0.0110	0.0132	W42	
➤ W8570TJ180	1800	8570	70200	24.60 x 10 <sup>6</sup>	0.690	0.050	175	0.0080	0.0085	W89	
➤ W8570TJ220	2200	8570	70200	24.60 x 10 <sup>6</sup>	0.690	0.050	175	0.0080	0.0085	W89	
➤ W8570TE180	1800	8570	70200	24.60 x 10 <sup>6</sup>	0.690	0.050	175	0.0080	0.0085	W94	
➤ W8570TE220	2200	8570	70200	24.60 x 10 <sup>6</sup>	0.690	0.050	175	0.0080	0.0085	W94	
➤ W9830TJ120	1200	9830	72000	25.90 x 10 <sup>6</sup>	0.670	0.043	190	0.0080	0.0085	W89	
➤ W9830TJ150	1500	9830	72000	25.90 x 10 <sup>6</sup>	0.670	0.043	190	0.0080	0.0085	W89	
➤ W9830TE120	1200	9830	72000	25.90 x 10 <sup>6</sup>	0.670	0.043	190	0.0080	0.0085	W94	
➤ W9830TE150	1500	9830	72000	25.90 x 10 <sup>6</sup>	0.670	0.043	190	0.0080	0.0085	W94	
										W94	

† = Avalanche rated diode  
‡ = Advanced data









For additional voltages, please contact the Chippenham Factory

# Fast Diodes

Fast Recovery Diodes are an essential complement to any switching device and are more often than not the limiting factor in the design and performance of modern power converters. To address the needs of our customers, we have developed an unparalleled range of Fast Recovery Diodes. These diodes are available with blocking voltages up to 6 kV making them suitable for operation with DC link voltages up to 3.3 kV and average current ratings to 4 kA depending upon type. The devices utilise compression bonding along with both alloyed and floating silicon technologies to deliver robust devices that you can rely on in demanding applications. This range has been sub-classified as follows to aid appropriate device selection; Fast Recovery, Soft Recovery, Extra Fast Recovery Diodes and HP Sonic-FRDs.

## Standard Fast Recovery Capsule Types

Fast Recovery Diodes: These parts are particularly suitable for use as anti-parallel diodes in Gate Turn-Off thyristors and Fast Thyristor inverters, diodes for choppers.

Type Part No.	V <sub>RRM</sub> V	I <sub>FAV</sub> T <sub>K</sub> = 55°C A	I <sub>FSM</sub> A	I <sup>2</sup> t 10 ms ½ sine V <sub>R</sub> ≤ 60% V <sub>RRM</sub> A2s	Typ. Reverse Recovery T <sub>J</sub> = 150°C				V <sub>T0</sub> V	r <sub>T</sub> mΩ	R <sub>thJK</sub> d.c. 180° sine K/W	Fig. No.	Package style Outlines on pages O-01...O-29
					t <sub>rr</sub> μs	Q <sub>rr</sub> μC	@ I <sub>FM</sub> A	@ -di <sub>F</sub> /dt A/μs					
M0588LC400	4000	588	3955	78.2 x 10 <sup>3</sup>	3.50	450	1000	60	2.320	1.770	0.0330	W4	
M0588LC450	4500	588	3955	78.2 x 10 <sup>3</sup>	3.50	450	1000	60	2.320	1.770	0.0330	W4	
M0790YC200	2000	790	9000	405 x 10 <sup>3</sup>	4.00	425	1000	60	1.272	0.584	0.0500	W2	
M0790YC250	2500	790	9000	405 x 10 <sup>3</sup>	4.00	425	1000	60	1.272	0.584	0.0500	W2	
M0790YH200	2000	790	9000	405 x 10 <sup>3</sup>	4.00	425	1000	60	1.272	0.584	0.0500	W3	
M0790YH250	2500	790	9000	405 x 10 <sup>3</sup>	4.00	425	1000	60	1.272	0.584	0.0500	W3	
M0914LC200	2000	914	8500	361 x 10 <sup>3</sup>	3.20	300	1000	60	1.768	0.653	0.0320	W4	
M0914LC250	2500	914	8500	361 x 10 <sup>3</sup>	3.20	300	1000	60	1.768	0.653	0.0320	W4	
M1010NC400	4000	1010	9600	461 x 10 <sup>3</sup>	3.20	1450	1000	200	1.700	1.030	0.0220	W5	
M1010NC450	4500	1010	9600	461 x 10 <sup>3</sup>	3.20	1450	1000	200	1.700	1.030	0.0220	W5	
M1010ND400	4000	1010	9600	461 x 10 <sup>3</sup>	3.20	1450	1000	200	1.700	1.030	0.0220	W37	
M1010ND450	4500	1010	9600	461 x 10 <sup>3</sup>	3.20	1450	1000	200	1.700	1.030	0.0220	W37	
M1163NC400	4000	1163	10800	583 x 10 <sup>3</sup>	6.40	1200	1000	60	1.500	0.770	0.0220	W5	
M1163NC450	4500	1163	10800	583 x 10 <sup>3</sup>	6.40	1200	1000	60	1.500	0.770	0.0220	W5	
M1163ND400	4000	1163	10800	583 x 10 <sup>3</sup>	6.40	1200	1000	60	1.500	0.770	0.0220	W37	
M1163ND450	4500	1163	10800	583 x 10 <sup>3</sup>	6.40	1200	1000	60	1.500	0.770	0.0220	W37	
M1502NC200	2000	1502	17000	1.45 x 10 <sup>6</sup>	3.50	350	1000	60	1.240	0.440	0.0220	W5	
M1502NC250	2500	1502	17000	1.45 x 10 <sup>6</sup>	3.50	350	1000	60	1.240	0.440	0.0220	W5	
M1502ND200	2000	1502	17000	1.45 x 10 <sup>6</sup>	3.50	350	1000	60	1.240	0.440	0.0220	W37	
M1502ND250	2500	1502	17000	1.45 x 10 <sup>6</sup>	3.50	350	1000	60	1.240	0.440	0.0220	W37	
M1583VC400	4000	1583	24800	3.08 x 10 <sup>6</sup>	5.00	2000	1000	200	1.693	0.525	0.0160	W6	
M1583VC450	4500	1583	24800	3.08 x 10 <sup>6</sup>	5.00	2000	1000	200	1.693	0.525	0.0160	W6	
M1583VF400	4000	1583	24800	3.08 x 10 <sup>6</sup>	5.00	2000	1000	200	1.693	0.525	0.0160	W43	
M1583VF450	4500	1583	24800	3.08 x 10 <sup>6</sup>	5.00	2000	1000	200	1.693	0.525	0.0160	W43	
M1609NC200	2000	1609	17500	1.53 x 10 <sup>6</sup>	3.20	800	1000	200	1.310	0.345	0.0220	W5	
M1609NC260	2600	1609	17500	1.53 x 10 <sup>6</sup>	3.20	800	1000	200	1.310	0.345	0.0220	W5	
M1609ND200	2000	1609	17500	1.53 x 10 <sup>6</sup>	3.20	800	1000	200	1.310	0.345	0.0220	W37	
M1609ND260	2600	1609	17500	1.53 x 10 <sup>6</sup>	3.20	800	1000	200	1.310	0.345	0.0220	W37	
M2273VC300	3000	2273	28000	3.92 x 10 <sup>6</sup>	8.50	2500	1000	60	1.239	0.244	0.0160	W6	
M2273VC360	3600	2273	28000	3.92 x 10 <sup>6</sup>	8.50	2500	1000	60	1.239	0.244	0.0160	W6	
M2273VF300	3000	2273	28000	3.92 x 10 <sup>6</sup>	8.50	2500	1000	60	1.239	0.244	0.0160	W43	
M2273VF360	3600	2273	28000	3.92 x 10 <sup>6</sup>	8.50	2500	1000	60	1.239	0.244	0.0160	W43	
M2408NC020	200	2408	24000	2.88 x 10 <sup>6</sup>	1.90	250	1000	200	1.065	0.122	0.0220	W5	
M2408NC060	600	2408	24000	2.88 x 10 <sup>6</sup>	1.90	250	1000	200	1.065	0.122	0.0220	W5	
M2408ND020	200	2408	24000	2.88 x 10 <sup>6</sup>	1.90	250	1000	200	1.065	0.122	0.0220	W37	
M2408ND060	600	2408	24000	2.88 x 10 <sup>6</sup>	1.90	250	1000	200	1.065	0.122	0.0220	W37	
M2639ZC420	4200	2639	27520	3.79 x 10 <sup>6</sup>	8.50	2300	1000	60	1.380	0.290	0.0110	W7	
M2639ZC450	4500	2639	27520	3.79 x 10 <sup>6</sup>	8.50	2300	1000	60	1.380	0.290	0.0110	W7	
M2639ZD420	4200	2639	27520	3.79 x 10 <sup>6</sup>	8.50	2300	1000	60	1.380	0.290	0.0110	W42	
M2639ZD450	4500	2639	27520	3.79 x 10 <sup>6</sup>	8.50	2300	1000	60	1.380	0.290	0.0110	W42	
M2698ZC250	2500	2698	27800	3.86 x 10 <sup>6</sup>	6.20	1200	1000	60	1.000	0.330	0.0110	W7	
M2698ZC280	2800	2698	27800	3.86 x 10 <sup>6</sup>	6.20	1200	1000	60	1.000	0.330	0.0110	W7	
M2698ZC350	3500	2698	27800	3.86 x 10 <sup>6</sup>	6.20	1200	1000	60	1.000	0.330	0.0110	W7	
M2698ZD250	2500	2698	27800	3.86 x 10 <sup>6</sup>	6.20	1200	1000	60	1.000	0.330	0.0110	W42	
M2698ZD280	2800	2698	27800	3.86 x 10 <sup>6</sup>	6.20	1200	1000	60	1.000	0.330	0.0110	W42	
M2698ZD350	3500	2698	27800	3.86 x 10 <sup>6</sup>	6.20	1200	1000	60	1.000	0.330	0.0110	W42	
M2837VC180	1800	2837	31800	5.10 x 10 <sup>6</sup>	7.00	2100	1000	60	0.900	0.170	0.0160	W6	
M2837VC250	2500	2837	31800	5.10 x 10 <sup>6</sup>	7.00	2100	1000	60	0.900	0.170	0.0160	W6	
M2837VF180	1800	2837	31800	5.10 x 10 <sup>6</sup>	7.00	2100	1000	60	0.900	0.170	0.0160	W43	
M2837VF250	2500	2837	31800	5.10 x 10 <sup>6</sup>	7.00	2100	1000	60	0.900	0.170	0.0160	W43	
M3770ZC200	2000	3770	44000	9.68 x 10 <sup>6</sup>	7.00	2000	1000	60	1.190	0.118	0.0110	W7	
M3770ZC240	2400	3770	44000	9.68 x 10 <sup>6</sup>	7.00	2000	1000	60	1.190	0.118	0.0110	W7	
M3770ZC300	3000	3770	44000	9.68 x 10 <sup>6</sup>	7.00	2000	1000	60	1.190	0.118	0.0110	W7	
M3770ZD200	2000	3770	44000	9.68 x 10 <sup>6</sup>	7.00	2000	1000	60	1.190	0.118	0.0110	W42	
M3770ZD240	2400	3770	44000	9.68 x 10 <sup>6</sup>	7.00	2000	1000	60	1.190	0.118	0.0110	W42	
M3770ZD300	3000	3770	44000	9.68 x 10 <sup>6</sup>	7.00	2000	1000	60	1.190	0.118	0.0110	W42	









T<sub>JM</sub> = 150°C

W43 Weight 800 g

# Soft Recovery Diodes



Our soft recovery diodes are available with a range of reverse recovery characteristics tailored to meet the requirements of both freewheeling and snubber applications. These devices are available with blocking voltages up to 6kV and average currents up to 2413A. 38mm to 75mm diameter silicon slices. These parts are particularly suitable where soft recovery is required, such as RCD snubbers, voltage clamping and snubberless applications.

## Stud Types

Type Part No.	$V_{RRM}$ V	$I_{FAV}$ A	$I_{FSM}$ A	$I^2t$ A <sup>2</sup> s	Typ. Reverse Recovery				$V_{TO}$		$T_{JM}$ °C	$R_{thJC}$ d.c. 180° sine K/W	Fig. No.	Package style Outlines on pages O-01...O-29
					$t_{rr}$ µs	$Q_{rr}$ µC	$T_{JM}$ @ $I_{FM}$ A	@ $-di_F/dt$ A/µs	V	mW				
M0130RL200	2000	130	2240	25.0 x 10 <sup>3</sup>	2.60	430	1000	150	1.290	1.540	125	0.3000	W20	
M0130RL250	2500	130	2240	25.0 x 10 <sup>3</sup>	2.60	430	1000	150	1.290	1.540	125	0.3000	W20	
M0130SL200	2000	130	2240	25.0 x 10 <sup>3</sup>	2.60	430	1000	150	1.290	1.540	125	0.3000	W20	
M0130SL250	2500	130	2240	25.0 x 10 <sup>3</sup>	2.60	430	1000	150	1.290	1.540	125	0.3000	W20	
M0139RL120	1200	139	2450	30.0 x 10 <sup>3</sup>	1.00	125	1000	100	1.240	1.280	125	0.3000	W20	
M0139RL180	1800	139	2450	30.0 x 10 <sup>3</sup>	1.00	125	1000	100	1.240	1.280	125	0.3000	W20	
M0139SL120	1200	139	2450	30.0 x 10 <sup>3</sup>	1.00	125	1000	100	1.240	1.280	125	0.3000	W20	
M0139SL180	1800	139	2450	30.0 x 10 <sup>3</sup>	1.00	125	1000	100	1.240	1.280	125	0.3000	W20	
M0268RC200	2000	268	4250	90.3 x 10 <sup>3</sup>	2.80	300	1000	150	1.210	1.200	125	0.1300	W24	
M0268RC250	2500	268	4250	90.3 x 10 <sup>3</sup>	2.80	300	1000	150	1.210	1.200	125	0.1300	W24	
M0268SC200	2000	268	4250	90.3 x 10 <sup>3</sup>	2.80	300	1000	150	1.210	1.200	125	0.1300	W24	
M0268SC250	2500	268	4250	90.3 x 10 <sup>3</sup>	2.80	300	1000	150	1.210	1.200	125	0.1300	W24	
M0268RJ200	2000	268	4250	90.3 x 10 <sup>3</sup>	2.80	300	1000	150	1.210	1.200	125	0.1300	W22	
M0268RJ250	2500	268	4250	90.3 x 10 <sup>3</sup>	2.80	300	1000	150	1.210	1.200	125	0.1300	W22	
M0268SJ200	2000	268	4250	90.3 x 10 <sup>3</sup>	2.80	300	1000	150	1.210	1.200	125	0.1300	W22	
M0268SJ250	2500	268	4250	90.3 x 10 <sup>3</sup>	2.80	300	1000	150	1.210	1.200	125	0.1300	W22	
M0280RC200	2000	280	4500	100 x 10 <sup>3</sup>	2.80	610	1000	150	1.280	0.920	125	0.1300	W24	
M0280RC250	2500	280	4500	100 x 10 <sup>3</sup>	2.80	610	1000	150	1.280	0.920	125	0.1300	W24	
M0280SC200	2000	280	4500	100 x 10 <sup>3</sup>	2.80	610	1000	150	1.280	0.920	125	0.1300	W24	
M0280SC250	2500	280	4500	100 x 10 <sup>3</sup>	2.80	610	1000	150	1.280	0.920	125	0.1300	W24	
M0280RJ200	2000	280	4500	100 x 10 <sup>3</sup>	2.80	610	1000	150	1.280	0.920	125	0.1300	W22	
M0280RJ250	2500	280	4500	100 x 10 <sup>3</sup>	2.80	610	1000	150	1.280	0.920	125	0.1300	W22	
M0280SJ200	2000	280	4500	100 x 10 <sup>3</sup>	2.80	610	1000	150	1.280	0.920	125	0.1300	W22	
M0280SJ250	2500	280	4500	100 x 10 <sup>3</sup>	2.80	610	1000	150	1.280	0.920	125	0.1300	W22	
M0334RC160	1600	334	4500	101 x 10 <sup>3</sup>	3.50	290	550	40	1.000	0.740	125	0.1300	W24	
M0334RC200	2000	334	4500	101 x 10 <sup>3</sup>	3.50	290	550	40	1.000	0.740	125	0.1300	W24	
M0334SC160	1600	334	4500	101 x 10 <sup>3</sup>	3.50	290	550	40	1.000	0.740	125	0.1300	W24	
M0334SC200	2000	334	4500	101 x 10 <sup>3</sup>	3.50	290	550	40	1.000	0.740	125	0.1300	W24	
M0334RJ160	1600	334	4500	101 x 10 <sup>3</sup>	3.50	290	550	40	1.000	0.740	125	0.1300	W22	
M0334RJ200	2000	334	4500	101 x 10 <sup>3</sup>	3.50	290	550	40	1.000	0.740	125	0.1300	W22	
M0334SJ160	1600	334	4500	101 x 10 <sup>3</sup>	3.50	290	550	40	1.000	0.740	125	0.1300	W22	
M0334SJ200	2000	334	4500	101 x 10 <sup>3</sup>	3.50	290	550	40	1.000	0.740	125	0.1300	W22	
M0336RA120	1200	336	4500	101 x 10 <sup>3</sup>	3.00	140	550	40	1.020	0.700	125	0.1300	W23	
M0336RA140	1400	336	4500	101 x 10 <sup>3</sup>	3.00	140	550	40	1.020	0.700	125	0.1300	W23	
M0336SA120	1200	336	4500	101 x 10 <sup>3</sup>	3.00	140	550	40	1.020	0.700	125	0.1300	W23	
M0336SA140	1400	336	4500	101 x 10 <sup>3</sup>	3.00	140	550	40	1.020	0.700	125	0.1300	W23	

W24 Weight 250 g







## Capsule Types

Type Part No.	$V_{RRM}$ V	$I_{FAV}$ A $T_K = 55^\circ C$	$I_{FSM}$ A	$I_2t$ A2s 10 ms ½ sine $V_R \leq 60\% V_{RRM}$	Typ. Reverse Recovery				$V_{TO}$ V	$r_T$ mΩ	$T_{JM}$ °C	$R_{thJK}$ d.c. 180° sine K/W	Fig. No.	Package style Outlines on pages O-01...O-29
					$t_{rr}$ μs	$Q_{rr}$ μC	$T_{JM}$ @ $I_{FM}$ A	@ $-di_F$ /dt A/μs						
M0225YH360	3600	225	2000	20 x 10 <sup>3</sup>	3.00	220	550	40	1.900	4.160	150	0.1000	W3	
M0225YH450	4500	225	2000	20 x 10 <sup>3</sup>	3.00	220	550	40	1.900	4.160	150	0.1000	W3	
M0310YH300	3000	310	4590	105 x 10 <sup>3</sup>	2.80	275	1000	100	1.490	2.060	150	0.1000	W3	
M0310YH350	3500	310	4590	105 x 10 <sup>3</sup>	2.80	275	1000	100	1.490	2.060	150	0.1000	W3	
M0347WC200	2000	347	4250	90.3 x 10 <sup>3</sup>	2.80	210	550	40	1.210	1.200	125	0.0900	W1	
M0347WC250	2500	347	4250	90.3 x 10 <sup>3</sup>	2.80	210	550	40	1.210	1.200	125	0.0900	W1	
M0358WC120	1200	358	2450	30 x 10 <sup>3</sup>	1.40	125	1000	100	1.460	0.800	125	0.0900	W1	
M0358WC180	1800	358	2450	30 x 10 <sup>3</sup>	1.40	125	1000	100	1.460	0.800	125	0.0900	W1	
M0367WC220	2200	367	4500	101 x 10 <sup>3</sup>	3.30	300	550	40	1.280	0.920	125	0.0900	W1	W1 Weight 70 g
M0367WC280	2800	367	4500	101 x 10 <sup>3</sup>	3.30	300	550	40	1.280	0.920	125	0.0900	W1	
M0371YH350	3500	371	4900	120 x 10 <sup>3</sup>	3.20	1260	1000	200	1.050	1.650	150	0.1000	W3	
M0371YH450	4500	371	4900	120 x 10 <sup>3</sup>	3.20	1260	1000	200	1.050	1.650	150	0.1000	W3	
M0433WC120	1200	433	4500	101 x 10 <sup>3</sup>	3.50	270	550	40	1.000	0.740	125	0.0900	W1	
M0433WC160	1600	433	4500	101 x 10 <sup>3</sup>	3.50	270	550	40	1.000	0.740	125	0.0900	W1	
M0433WC200	2000	433	4500	101 x 10 <sup>3</sup>	3.50	270	550	40	1.000	0.740	125	0.0900	W1	
M0437WC080	800	437	4500	101 x 10 <sup>3</sup>	3.00	140	550	40	1.020	0.700	125	0.0900	W1	
M0437WC140	1400	437	4500	101 x 10 <sup>3</sup>	3.00	140	550	40	1.020	0.700	125	0.0900	W1	
M0451YC160	1600	451	4500	101 x 10 <sup>3</sup>	2.80	220	550	40	1.000	0.740	125	0.0850	W2	
M0451YC200	2000	451	4500	101 x 10 <sup>3</sup>	2.80	220	550	40	1.000	0.740	125	0.0850	W2	
M0659LC400	4000	659	7620	290 x 10 <sup>3</sup>	4.20	800	1000	60	1.710	0.925	125	0.0330	W4	
M0659LC450	4500	659	7620	290 x 10 <sup>3</sup>	4.20	800	1000	60	1.710	0.925	125	0.0330	W4	
M0710LC560	5600	710	8400	353 x 10 <sup>3</sup>	4.00	2100	1000	200	1.450	0.875	125	0.0330	W4	
M0710LC600	6000	710	8400	353 x 10 <sup>3</sup>	4.00	2100	1000	200	1.450	0.875	125	0.0330	W4	
M0736LC400	4000	736	9000	405 x 10 <sup>3</sup>	5.20	1250	1000	60	1.606	0.700	125	0.0330	W4	
M0736LC450	4500	736	9000	405 x 10 <sup>3</sup>	5.20	1250	1000	60	1.606	0.700	125	0.0330	W4	
M0759YC120	1200	759	9500	450 x 10 <sup>3</sup>	2.00	80	550	50	1.130	0.380	125	0.0500	W2	
M0759YC160	1600	759	9500	450 x 10 <sup>3</sup>	2.00	80	550	50	1.130	0.380	125	0.0500	W2	
M0759YH120	1200	759	9500	450 x 10 <sup>3</sup>	2.00	80	550	50	1.130	0.380	125	0.0500	W3	
M0759YH160	1600	759	9500	450 x 10 <sup>3</sup>	2.00	80	550	50	1.130	0.380	125	0.0500	W3	
M0859LC140	1400	859	10000	500 x 10 <sup>3</sup>	3.00	280	800	50	1.170	0.320	125	0.0440	W4	
M0859LC160	1600	859	10000	500 x 10 <sup>3</sup>	3.00	280	800	50	1.170	0.320	125	0.0440	W4	
M0863LC260	2600	863	10000	500 x 10 <sup>3</sup>	4.80	950	1000	60	1.308	0.538	125	0.0330	W4	
M0863LC300	3000	863	10000	500 x 10 <sup>3</sup>	4.80	950	1000	60	1.308	0.538	125	0.0330	W4	
M0863LC360	3600	863	10000	500 x 10 <sup>3</sup>	4.80	950	1000	60	1.308	0.538	125	0.0330	W4	
M0872LC140	1400	872	10000	500 x 10 <sup>3</sup>	4.00	700	1000	60	1.090	0.340	125	0.0440	W4	
M0872LC180	1800	872	10000	500 x 10 <sup>3</sup>	4.00	700	1000	60	1.090	0.340	125	0.0440	W4	
M0872LC210	2100	872	10000	500 x 10 <sup>3</sup>	4.00	700	1000	60	1.090	0.340	125	0.0440	W4	
M0955LC200	2000	955	11700	684 x 10 <sup>3</sup>	3.40	500	1000	60	1.440	0.330	125	0.0330	W4	
M0955LC250	2500	955	11700	684 x 10 <sup>3</sup>	3.40	500	1000	60	1.440	0.330	125	0.0330	W4	
M1022LC120	1200	1022	14000	980 x 10 <sup>3</sup>	3.00	375	1000	60	1.240	0.330	125	0.0330	W4	
M1022LC160	1600	1022	14000	980 x 10 <sup>3</sup>	3.00	375	1000	60	1.240	0.330	125	0.0330	W4	
M1022LC200	2000	1022	14000	980 x 10 <sup>3</sup>	3.00	375	1000	60	1.240	0.330	125	0.0330	W4	

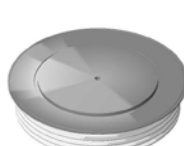

# Soft Recovery Diodes

## Capsule Types

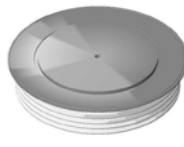
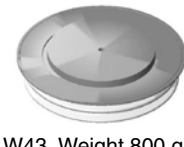
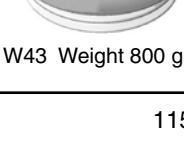
Type Part No.	V <sub>RRM</sub> V	I <sub>FAV</sub> A T <sub>K</sub> = 55°C	I <sub>FSM</sub> A 10 ms ½ sine V <sub>R</sub> ≤ 60% V <sub>RRM</sub>	I <sup>2</sup> t A <sup>2</sup> s	Typ. Reverse Recovery				V <sub>TO</sub> V	r <sub>T</sub> mΩ	T <sub>JM</sub> °C	R <sub>thJK</sub> d.c. 180° sine K/W	Fig. No.	Package style Outlines on pages O-01...O-29
					t <sub>rr</sub> μs	Q <sub>rr</sub> μC	@ I <sub>FM</sub> A	@ -di <sub>F</sub> /dt A/μs						
M1080LC100	1000	1080	13500	910 x 10 <sup>3</sup>	1.90	85	1000	60	1.125	0.314	125	0.0330	W4	
M1080LC120	1200	1080	13500	910 x 10 <sup>3</sup>	1.90	85	1000	60	1.125	0.314	125	0.0330	W4	
M1102NC500	5000	1102	13000	845 x 10 <sup>3</sup>	5.50	3300	1000	200	1.360	0.557	125	0.0220	W5	 W5 Weight 510 g
M1102NC600	6000	1102	13000	845 x 10 <sup>3</sup>	5.50	3300	1000	200	1.360	0.557	125	0.0220	W5	
M1102ND500	5000	1102	13000	845 x 10 <sup>3</sup>	5.50	3300	1000	200	1.360	0.557	125	0.0220	W37	
M1102ND600	6000	1102	13000	845 x 10 <sup>3</sup>	5.50	3300	1000	200	1.360	0.557	125	0.0220	W37	
M1104NC400	4000	1104	13000	845 x 10 <sup>3</sup>	6.00	2100	1000	60	1.370	0.553	125	0.0220	W5	 W5 Weight 510 g
M1104NC450	4500	1104	13000	845 x 10 <sup>3</sup>	6.00	2100	1000	60	1.370	0.553	125	0.0220	W5	
M1104ND400	4000	1104	13000	845 x 10 <sup>3</sup>	6.00	2100	1000	60	1.370	0.553	125	0.0220	W37	
M1104ND450	4500	1104	13000	845 x 10 <sup>3</sup>	6.00	2100	1000	60	1.370	0.553	125	0.0220	W37	
M1242NC260	2600	1242	16400	1.34 x 10 <sup>6</sup>	6.00	1500	1000	60	1.270	0.420	125	0.0220	W5	 W5 Weight 510 g
M1242NC360	3600	1242	16400	1.34 x 10 <sup>6</sup>	6.00	1500	1000	60	1.270	0.420	125	0.0220	W5	
M1242ND260	2600	1242	16400	1.34 x 10 <sup>6</sup>	6.00	1500	1000	60	1.270	0.420	125	0.0220	W37	
M1242ND360	3600	1242	16400	1.34 x 10 <sup>6</sup>	6.00	1500	1000	60	1.270	0.420	125	0.0220	W37	
M1494NC180	1800	1494	19600	1.92 x 10 <sup>6</sup>	3.90	815	1000	60	1.150	0.265	125	0.0220	W5	 W5 Weight 1000 g
M1494NC250	2500	1494	19600	1.92 x 10 <sup>6</sup>	3.90	815	1000	60	1.150	0.265	125	0.0220	W5	
M1494ND180	1800	1494	19600	1.92 x 10 <sup>6</sup>	3.90	815	1000	60	1.150	0.265	125	0.0220	W37	
M1494ND250	2500	1494	19600	1.92 x 10 <sup>6</sup>	3.90	815	1000	60	1.150	0.265	125	0.0220	W37	
M1565VC360	3600	1565	19700	1.94 x 10 <sup>6</sup>	5.00	2800	1000	200	1.090	0.360	125	0.0180	W6	 W6 Weight 510 g
M1565VC400	4000	1565	19700	1.94 x 10 <sup>6</sup>	5.00	2800	1000	200	1.090	0.360	125	0.0180	W6	
M1565VC450	4500	1565	19700	1.94 x 10 <sup>6</sup>	5.00	2800	1000	200	1.090	0.360	125	0.0180	W6	
M1565VF360	3600	1565	19700	1.94 x 10 <sup>6</sup>	5.00	2800	1000	200	1.090	0.360	125	0.0180	W43	
M1565VF400	4000	1565	19700	1.94 x 10 <sup>6</sup>	5.00	2800	1000	200	1.090	0.360	125	0.0180	W43	
M1565VF450	4500	1565	19700	1.94 x 10 <sup>6</sup>	5.00	2800	1000	200	1.090	0.360	125	0.0180	W43	
M1858NC120	1200	1858	25000	3.25 x 10 <sup>6</sup>	2.50	120	1000	60	1.127	0.127	125	0.0220	W5	 W5 Weight 1200 g
M1858NC160	1600	1858	25000	3.25 x 10 <sup>6</sup>	2.50	120	1000	60	1.127	0.127	125	0.0220	W5	
M1858ND120	1200	1858	25000	3.25 x 10 <sup>6</sup>	2.50	120	1000	60	1.127	0.127	125	0.0220	W37	
M1858ND160	1600	1858	25000	3.25 x 10 <sup>6</sup>	2.50	120	1000	60	1.127	0.127	125	0.0220	W37	
M2322ZC300	3000	2322	23000	2.64 x 10 <sup>6</sup>	6.50	3200	1000	150	1.670	0.186	125	0.0110	W7	 W7 Weight 800 g
M2322ZC400	4000	2322	23000	2.64 x 10 <sup>6</sup>	6.50	3200	1000	150	1.670	0.186	125	0.0110	W7	
M2322ZD300	3000	2322	23000	2.64 x 10 <sup>6</sup>	6.50	3200	1000	150	1.670	0.186	125	0.0110	W42	
M2322ZD400	4000	2322	23000	2.64 x 10 <sup>6</sup>	6.50	3200	1000	150	1.670	0.186	125	0.0110	W42	
M2413VC200	2000	2413	32000	5.12 x 10 <sup>6</sup>	5.00	2500	1000	200	1.090	0.121	125	0.0160	W6	 W6 Weight 800 g
M2413VC250	2500	2413	32000	5.12 x 10 <sup>6</sup>	5.00	2500	1000	200	1.090	0.121	125	0.0160	W6	
M2413VF200	2000	2413	32000	5.12 x 10 <sup>6</sup>	5.00	2500	1000	200	1.090	0.121	125	0.0160	W43	
M2413VF250	2500	2413	32000	5.12 x 10 <sup>6</sup>	5.00	2500	1000	200	1.090	0.121	125	0.0160	W43	

# Extra Fast Recovery Diodes

Featuring a combination of the latest developments in lifetime engineering technologies. These products are designed to offer the lowest practical values of reverse recovery current whilst offering wide safe operating area and high di/dt capability required by modern switching components such as IGBT's and GCT's as well as pulsed power applications.

## Capsule Types

Type Part No.	$V_{RRM}$ V	$I_{FAV}$ A $T_K = 55^\circ C$	$I_{FSM}$ A	$I^2t$ A <sup>2</sup> s 10 ms ½ sine $V_R \leq 60\% V_{RRM}$	Typ. Reverse Recovery					$V_{TO}$ V	$r_T$ mΩ @ $T_{JM}$	$T_{JM}$ °C	$R_{thJK}$ d.c. 180° sine K/W	Fig. No.
					$I_{rm}$ A	$t_{rr}$ μs	$Q_{rr}$ μC	@ $I_{FM}$ A	@ -di <sub>F</sub> /dt A/μs					
> <b>New</b>	V	A	A	A <sup>2</sup> s	A	μs	μC	A	A/μs	V	mΩ	°C	K/W	
<b>F0240YC250</b>	2500	240	3100	48.1 x 10 <sup>3</sup>	190	1.65	300	550	300	2.271	2.853	150	0.1000	W2
<b>F0240YC300</b>	3000	240	3100	48.1 x 10 <sup>3</sup>	190	1.65	300	550	300	2.271	2.853	150	0.1000	W2
<b>F0240YH250</b>	2500	240	3100	48.1 x 10 <sup>3</sup>	190	1.65	300	550	300	2.271	2.853	150	0.1000	W3
<b>F0240YH300</b>	3000	240	3100	48.1 x 10 <sup>3</sup>	190	1.65	300	550	300	2.271	2.853	150	0.1000	W3
<b>F0300WC140</b>	1400	240	2700	36.5 x 10 <sup>3</sup>	530	0.30	140	300	2000	1.760	2.210	125	0.0950	W1
<b>F0300WC180</b>	1800	240	2700	36.5 x 10 <sup>3</sup>	530	0.30	140	300	2000	1.760	2.210	125	0.0950	W1
<b>F0800LC140</b>	1400	775	7630	291 x 10 <sup>3</sup>	380	1.10	500	800	1000	1.494	0.692	125	0.0320	W4
<b>F0800LC180</b>	1800	775	7630	291 x 10 <sup>3</sup>	380	1.10	500	800	1000	1.494	0.692	125	0.0320	W4
<b>F0900VC450</b>	4500	816	10450	546 x 10 <sup>3</sup>	3000	1.40	2500	900	2000	2.024	1.274	115	0.0160	W6
<b>F0900VC520</b>	5200	816	10450	546 x 10 <sup>3</sup>	3000	1.40	2500	900	2000	2.024	1.274	115	0.0160	W6
<b>F0900VF450</b>	4500	816	10450	546 x 10 <sup>3</sup>	3000	1.40	2500	900	2000	2.024	1.274	115	0.0160	W43
<b>F0900VF520</b>	5200	816	10450	546 x 10 <sup>3</sup>	3000	1.40	2500	900	2000	2.024	1.274	115	0.0160	W43
<b>F1000LC080</b>	800	826	8500	361 x 10 <sup>3</sup>	320	1.60	450	1000	800	1.530	0.547	125	0.0320	W4
<b>F1000LC120</b>	1200	826	8500	361 x 10 <sup>3</sup>	320	1.60	450	1000	800	1.530	0.547	125	0.0320	W4
<b>F1300NC45P</b>	4500	1346	20800	2.16 x 10 <sup>6</sup>	470	4.30	2150	1000	200	1.569	0.318	140	0.0240	W5
<b>F1300NC50P</b>	5000	1346	20800	2.16 x 10 <sup>6</sup>	470	4.30	2150	1000	200	1.569	0.318	140	0.0240	W5
<b>F1300NC55P</b>	5500	1346	20800	2.16 x 10 <sup>6</sup>	470	4.30	2150	1000	200	1.569	0.318	140	0.0240	W5
<b>F1300NH45P</b>	4500	1346	20800	2.16 x 10 <sup>6</sup>	470	4.30	2150	1000	200	1.569	0.318	140	0.0240	W47
<b>F1300NH50P</b>	5000	1346	20800	2.16 x 10 <sup>6</sup>	470	4.30	2150	1000	200	1.569	0.318	140	0.0240	W47
<b>F1300NH55P</b>	5500	1346	20800	2.16 x 10 <sup>6</sup>	470	4.30	2150	1000	200	1.569	0.318	140	0.0240	W47
<b>F1400NC140</b>	1400	1093	17250	1.49 x 10 <sup>6</sup>	800	1.50	1000	1400	1000	1.618	0.388	125	0.0240	W5
<b>F1400NC180</b>	1800	1093	17250	1.49 x 10 <sup>6</sup>	800	1.50	1000	1400	1000	1.618	0.388	125	0.0240	W5
<b>F1400ND140</b>	1400	1093	17250	1.49 x 10 <sup>6</sup>	800	1.50	1000	1400	1000	1.618	0.388	125	0.0240	W37
<b>F1400ND180</b>	1800	1093	17250	1.49 x 10 <sup>6</sup>	800	1.50	1000	1400	1000	1.618	0.388	125	0.0240	W37
<b>F1500NC200</b>	2000	1054	13750	950 x 10 <sup>3</sup>	1065	1.50	1500	1500	2000	1.372	0.535	125	0.0240	W5
<b>F1500NC250</b>	2500	1054	13750	950 x 10 <sup>3</sup>	1065	1.50	1500	1500	2000	1.372	0.535	125	0.0240	W5
<b>F1600NC080</b>	800	1326	20000	2.0 x 10 <sup>6</sup>	480	2.30	700	1600	800	1.320	0.268	125	0.0240	W5
<b>F1600NC120</b>	1200	1326	20000	2.0 x 10 <sup>6</sup>	480	2.30	700	1600	800	1.320	0.268	125	0.0240	W5



W1 Weight 70 g



W2 Weight 80 g



W3 Weight 140 g



W4 Weight 340 g



W5 Weight 510 g

Outlines on pages  
O-01...O-29



W6 Weight 1000 g



W37 Weight 510 g

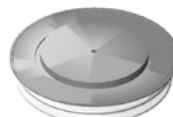

W43 Weight 800 g



W47 Weight 250 g

# High Power Sonic FRD's

Introducing a world-leading class of ultra fast and ultra soft recovery diode available from 1.4kV to 4.5kV in current ratings from 170 to 4000A. These diodes incorporate a unique manufacturing process and lifetime control to offer a class leading trade-off between conduction and switching losses. The wide safe operating area (SOA) makes them ideal as freewheeling diodes for snubberless IGBT and IGCT applications. In fact, any application which requires a fast, low loss diode. For example, traction, medium voltage drives, induction heating and pulsed power applications.

## Capsule Types

Type Part No.	V <sub>RRM</sub> V	I <sub>FAV</sub> A T <sub>K</sub> = 55°C	I <sub>FSM</sub> A	I <sup>2</sup> t 10 ms ½ sine V <sub>R</sub> ≤ 60% V <sub>RRM</sub> A <sup>2</sup> s	Typ. Reverse Recovery					V <sub>TO</sub> V	r <sub>T</sub> mΩ @T <sub>JM</sub>	T <sub>JM</sub> °C	R <sub>thJK</sub> 180° Sine K/W	Fig. No.
					I <sub>rm</sub> A	t <sub>rr</sub> μs	Q <sub>rr</sub> μC	@ I <sub>FM</sub> A	@ -di <sub>F</sub> /dt A/μs					
➤ <b>E0170YH40C</b>	4000	208	1800	16.2 x 10 <sup>3</sup>	125	1.60	215	170	300	2.340	7.650	150	0.073	W3
<b>E0170YH45C</b>	4500	208	1800	16.2 x 10 <sup>3</sup>	125	1.60	215	170	200	2.340	7.650	150	0.073	W3
<b>E0280YH20C</b>	2000	391	3200	51.2 x 10 <sup>3</sup>	225	2.30	520	280	300	1.660	1.720	150	0.073	W3
<b>E0280YH25C</b>	2500	391	3200	51.2 x 10 <sup>3</sup>	225	2.30	520	280	300	1.660	1.720	150	0.073	W3
<b>E0460QC40C</b>	4000	532	5750	165 x 10 <sup>3</sup>	450	1.00	900	500	1500	2.150	3.040	150	0.029	W68
<b>E0460QC45C</b>	4500	532	5750	165 x 10 <sup>3</sup>	450	1.00	900	500	1500	2.150	3.040	150	0.029	W68
<b>E0660NC40C</b>	4000	783	7100	252 x 10 <sup>3</sup>	625	1.75	1100	660	850	2.270	1.960	150	0.020	W5
<b>E0660NC45C</b>	4500	783	7100	252 x 10 <sup>3</sup>	625	1.75	1100	660	850	2.270	1.960	150	0.020	W5
<b>E0660NH40C</b>	4500	783	7100	252 x 10 <sup>3</sup>	625	1.75	1100	660	850	2.270	1.960	150	0.020	W47
<b>E0660NH45C</b>	4500	783	7100	252 x 10 <sup>3</sup>	625	1.75	1100	660	850	2.270	1.960	150	0.020	W47
<b>E0800QC20C</b>	2000	960	10700	575 x 10 <sup>3</sup>	720	1.60	1420	800	1500	1.410	0.839	150	0.029	W68
<b>E0800QC25C</b>	2500	960	10700	575 x 10 <sup>3</sup>	720	1.60	1420	800	1500	1.410	0.839	150	0.029	W68
<b>E1200NC20C</b>	2000	1473	12900	832 x 10 <sup>3</sup>	650	3.80	2000	1200	1500	1.620	0.440	150	0.020	W5
<b>E1200NC25C</b>	2500	1473	12900	832 x 10 <sup>3</sup>	650	3.80	2000	1200	1500	1.620	0.440	150	0.020	W5
<b>E1200NH20C</b>	2000	1473	12900	832 x 10 <sup>3</sup>	650	3.80	2000	1200	1500	1.620	0.440	150	0.020	W47
<b>E1200NH25C</b>	2500	1473	12900	832 x 10 <sup>3</sup>	650	3.80	2000	1200	1500	1.620	0.440	150	0.020	W47
<b>E1300VF40C</b>	4000	1350	14000	1.08 x 10 <sup>6</sup>	1500	1.10	2150	1300	3000	2.310	0.930	150	0.013	W43
<b>E1300VF45C</b>	4500	1350	14000	1.08 x 10 <sup>6</sup>	1500	1.10	2150	1300	3000	2.310	0.930	150	0.013	W43
<b>E1500NC36P</b>	3600	1280	17050	1.45 x 10 <sup>6</sup>	1425	2.80	2750	1000	1000	1.417	0.656	140	0.019	W5
<b>E1500NC42P</b>	4200	1280	17050	1.45 x 10 <sup>6</sup>	1425	2.80	2750	1000	1000	1.417	0.656	140	0.019	W5
<b>E1500NC48P</b>	4800	1280	17050	1.45 x 10 <sup>6</sup>	1425	2.80	2750	1000	1000	1.417	0.656	140	0.019	W5
<b>E1500NH36P</b>	3600	1280	17050	1.45 x 10 <sup>6</sup>	1425	2.80	2750	1000	1000	1.417	0.656	140	0.019	W47
<b>E1500NH42P</b>	4200	1280	17050	1.45 x 10 <sup>6</sup>	1425	2.80	2750	1000	1000	1.417	0.656	140	0.019	W47
<b>E1500NH48P</b>	4800	1280	17050	1.45 x 10 <sup>6</sup>	1425	2.80	2750	1000	1000	1.417	0.656	140	0.019	W47
<b>E2000NC140</b>	1400	1568	15000	1.13 x 10 <sup>6</sup>	1870	1.00	1670	2000	4000	1.770	0.350	150	0.020	W5
<b>E2000NC170</b>	1700	1568	15000	1.13 x 10 <sup>6</sup>	1870	1.00	1670	2000	4000	1.770	0.350	150	0.020	W5
<b>E2000NH140</b>	1400	1568	15000	1.13 x 10 <sup>6</sup>	1870	1.00	1670	2000	4000	1.770	0.350	150	0.020	W47
<b>E2000NH170</b>	1700	1568	15000	1.13 x 10 <sup>6</sup>	1870	1.00	1670	2000	4000	1.770	0.350	150	0.020	W47
<b>E2250VF20C</b>	2000	2426	25200	3.17 x 10 <sup>6</sup>	1650	1.90	3700	2250	2500	1.510	0.250	150	0.013	W43
<b>E2250VF25C</b>	2500	2426	25200	3.17 x 10 <sup>6</sup>	1650	1.90	3700	2250	2500	1.510	0.250	150	0.013	W43
<b>E2400TC40C</b>	4000	2233	25600	3.29 x 10 <sup>6</sup>	2050	1.50	3700	2400	3000	2.060	0.590	150	0.008	W28
<b>E2400TC45C</b>	4500	2233	25600	3.29 x 10 <sup>6</sup>	2050	1.50	3700	2400	3000	2.060	0.590	150	0.008	W28
<b>E4000TC20C</b>	2000	4080	50000	12.5 x 10 <sup>6</sup>	2480	2.50	6700	4000	3500	1.406	0.149	150	0.008	W28
<b>E4000TC25C</b>	2500	4080	50000	12.5 x 10 <sup>6</sup>	2480	2.50	6700	4000	3500	1.406	0.149	150	0.008	W28

Outlines on pages  
O-01...O-29



W43 Weight 800 g



W3 Weight 140 g



W47 Weight 250 g



W5 Weight 510 g



W68 Weight 300 g



W28 Weight 1230 g

# Phase Control Thyristors

IXYS UK provides one of the most comprehensive ranges of standard phase control thyristors in the industry. Devices with voltage ranges from 400V to 6500V are available, making them suitable for applications with line voltages from 230V to over 1000V (higher voltage applications are now served by our range of Medium Voltage Thyristors). IXYS UK Westcode Ltd. is a leading supplier of phase control products into demanding markets such as industrial DC drives, controlled rectifiers, marine/rail propulsion systems, wind power converters, electrochemical power supplies and soft starters. These devices are optimised to give low conduction losses and are primarily intended for applications with line frequencies up to 400Hz.

The Wespac outline (WPxx) is a new concept in phase control thyristors for applications requiring devices rated to 2200V. It gives the maximum power rating for weight and volume without compromising on quality and reliability. It also gives the maximum current rating and lowest thermal resistance for the package size.

The newest additions to IXYS UK's phase control thyristor range are the 83mm dia Si capsules. These devices are of alloyed construction offering better thermal and electromechanical capability and are available with current ratings up to 4340A and voltage ratings up to 4500V.

## Stud Types

Part No.	$V_{DRM}$	$I_{TAV}$	$I_{TSM}$	$I^2t$ 10 ms ½ sine $V_R \leq 60\% V_{RRM}$	$V_{T0}$	$r_T$	$T_{JM}$	$R_{thJC}$		Fig. No.
	$V_{RRM}$	$T_C = 55^\circ C$						d.c.	120°	
	V	A						180° sine	Rect.	
<b>N0131SH120</b>	1200	131	1700	$14.5 \times 10^3$	1.570	2.290	125	0.2300	0.2800	W17
<b>N0131SH160</b>	1600	131	1700	$14.5 \times 10^3$	1.570	2.290	125	0.2300	0.2800	W17
<b>N0180SH120</b>	1200	180	2450	$30.0 \times 10^3$	0.900	1.790	125	0.2300	0.2800	W17
<b>N0180SH160</b>	1600	180	2450	$30.0 \times 10^3$	0.900	1.790	125	0.2300	0.2800	W17
<b>N0290SC120</b>	1200	290	4200	$88.2 \times 10^3$	1.080	1.300	125	0.1200	0.1400	W18
<b>N0290SC160</b>	1600	290	4200	$88.2 \times 10^3$	1.080	1.300	125	0.1200	0.1400	W18
<b>N0335SC120</b>	1200	335	4650	$108 \times 10^3$	0.920	0.990	125	0.1200	0.1400	W18
<b>N0335SC160</b>	1600	335	4650	$108 \times 10^3$	0.920	0.990	125	0.1200	0.1400	W18
<b>N0416SC040</b>	400	416	6000	$180 \times 10^3$	0.850	0.535	125	0.1200	0.1400	W18
<b>N0416SC080</b>	800	416	6000	$180 \times 10^3$	0.850	0.535	125	0.1200	0.1400	W18

Outlines on pages  
O-01...O-29

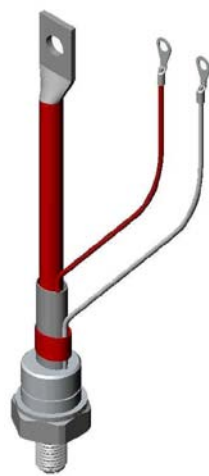



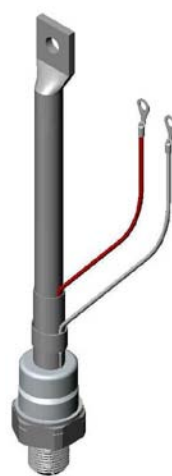



















W17 Weight 130 g



W18 Weight 280 g





# Phase Control Thyristors

## Capsule Types

Type Part No. ○ Not for new design ➤ New	$V_{DRM}$ $V_{RRM}$	$I_{TAV}$ $T_K = 55^\circ C$	$I_{TSM}$	$I^2t$ 10 ms ½ sine $V_R \leq 60\% V_{RRM}$	$V_{TO}$	$r_T$ @ $T_{JM}$	$T_{JM}$	$R_{thJC}$		Fig. No.	Package style Outlines on pages O-01...O-29
	V	A	A	A <sup>2</sup> s	V	mΩ	°C	180° Sine K/W	120° Rect. K/W		
○ N0255WC120	1200	255	2450	30.0 x 10 <sup>3</sup>	0.900	1.790	125	0.1350	0.1900	W8	
○ N0255WC160	1600	255	2450	30.0 x 10 <sup>3</sup>	0.900	1.790	125	0.1350	0.1900	W8	
○ N0392WC120	1200	392	4650	108 x 10 <sup>3</sup>	0.920	0.990	125	0.0950	0.1100	W8	
○ N0392WC160	1600	392	4650	108 x 10 <sup>3</sup>	0.920	0.990	125	0.0950	0.1100	W8	
➤ N0465WN140	1400	465	4500	101 x 10 <sup>3</sup>	0.900	0.850	125	0.0800	0.0960	W90	
➤ N0465WN160	1600	465	4500	101 x 10 <sup>3</sup>	0.900	0.850	125	0.0800	0.0960	W90	
➤ N0530YN220	2200	530	6300	198 x 10 <sup>3</sup>	1.100	1.250	125	0.0480	0.0494	W91	
➤ N0530YN250	2500	530	6300	198 x 10 <sup>3</sup>	1.100	1.250	125	0.0480	0.0494	W91	
○ N0606YS200	2000	606	7100	252 x 10 <sup>3</sup>	1.103	0.804	125	0.0500	0.0580	W9	
○ N0606YS240	2400	606	7100	252 x 10 <sup>3</sup>	1.103	0.804	125	0.0500	0.0580	W9	
○ N0606YS250	2500	606	7100	252 x 10 <sup>3</sup>	1.103	0.804	125	0.0500	0.0580	W9	
N0616LC400	4000	616	5250	138 x 10 <sup>3</sup>	1.220	1.530	125	0.0320	0.0397	W10	
N0616LC450	4500	616	5250	138 x 10 <sup>3</sup>	1.220	1.530	125	0.0320	0.0397	W10	
N0634LC380	3800	634	7000	245 x 10 <sup>3</sup>	1.100	1.500	125	0.0320	0.0397	W10	
N0634LC420	4200	634	7000	245 x 10 <sup>3</sup>	1.100	1.500	125	0.0320	0.0397	W10	
N0646LC300	3000	646	5700	162 x 10 <sup>3</sup>	1.210	1.360	125	0.0320	0.0397	W10	
N0646LC360	3600	646	5700	162 x 10 <sup>3</sup>	1.210	1.360	125	0.0320	0.0397	W10	
○ N0676YS120	1200	676	7500	281 x 10 <sup>3</sup>	1.090	0.587	125	0.0500	0.0580	W9	
○ N0676YS180	1800	676	7500	281 x 10 <sup>3</sup>	1.090	0.587	125	0.0500	0.0580	W9	
○ N0734YS120	1200	734	8400	353 x 10 <sup>3</sup>	1.030	0.483	125	0.0500	0.0580	W9	
○ N0734YS160	1600	734	8400	353 x 10 <sup>3</sup>	1.030	0.483	125	0.0500	0.0580	W9	
○ N0782YS120	1200	782	9420	444 x 10 <sup>3</sup>	0.920	0.450	125	0.0500	0.0580	W9	
○ N0782YS160	1600	782	9420	444 x 10 <sup>3</sup>	0.920	0.450	125	0.0500	0.0580	W9	
➤ N0795YN140	1400	795	9450	444 x 10 <sup>3</sup>	0.950	0.450	125	0.0480	0.0494	W91	
➤ N0795YN180	1800	795	9450	444 x 10 <sup>3</sup>	0.950	0.450	125	0.0480	0.0494	W91	
N0845NC600 ø	6000	845	9500	451 x 10 <sup>3</sup>	1.100	0.890	115	0.0240	0.0271	W11	
N0845NC650 ø	6500	845	9500	451 x 10 <sup>3</sup>	1.100	0.890	115	0.0240	0.0271	W11	
N0845NG600 ø	6000	845	9500	451 x 10 <sup>3</sup>	1.100	0.890	115	0.0240	0.0271	W57	
N0845NG650 ø	6500	845	9500	451 x 10 <sup>3</sup>	1.100	0.890	115	0.0240	0.0271	W57	
N0882NC400	4000	882	7700	296 x 10 <sup>3</sup>	1.300	0.920	125	0.0240	0.0273	W11	
N0882NC450	4500	882	7700	296 x 10 <sup>3</sup>	1.300	0.920	125	0.0240	0.0273	W11	
N0910LC200	2000	910	9200	423 x 10 <sup>3</sup>	1.040	0.606	125	0.0320	0.0397	W10	
N0910LC260	2600	910	9200	423 x 10 <sup>3</sup>	1.040	0.606	125	0.0320	0.0397	W10	
N1010NC300	3000	1010	12100	732 x 10 <sup>3</sup>	1.170	0.687	125	0.0240	0.0273	W11	
N1010NC380	3800	1010	12100	732 x 10 <sup>3</sup>	1.170	0.687	125	0.0240	0.0273	W11	
➤ N1075LN180	1800	1075	15750	1.24 x 10 <sup>6</sup>	0.850	0.320	125	0.0410	0.0492	W92	
○ N1114LC120	1200	1114	12700	806 x 10 <sup>3</sup>	1.000	0.349	125	0.0320	0.0397	W10	
○ N1114LC180	1800	1114	12700	806 x 10 <sup>3</sup>	1.000	0.349	125	0.0320	0.0397	W10	
N1132NC300	3000	1132	14300	1.02 x 10 <sup>6</sup>	1.150	0.510	125	0.0240	0.0271	W11	
N1132NC320	3200	1132	14300	1.02 x 10 <sup>6</sup>	1.150	0.510	125	0.0240	0.0271	W11	
➤ N1140LN140	1400	1140	17500	1.53 x 10 <sup>6</sup>	0.820	0.280	125	0.0380	0.0456	W92	
N1159NC380	3800	1159	14500	1.05 x 10 <sup>6</sup>	1.100	0.574	125	0.0220	0.0255	W11	
N1159NC420	4200	1159	14500	1.05 x 10 <sup>6</sup>	1.100	0.574	125	0.0220	0.0255	W11	
N1174JK200	2000	1174	13200	870 x 10 <sup>3</sup>	1.000	0.416	125	0.0270	0.0314	WP1	
N1174JK220	2200	1174	13200	870 x 10 <sup>3</sup>	1.000	0.416	125	0.0270	0.0314	WP1	
N1263JK160	1600	1263	15000	1.13 x 10 <sup>6</sup>	1.015	0.332	125	0.0270	0.0314	WP1	
N1263JK180	1800	1263	15000	1.13 x 10 <sup>6</sup>	1.015	0.332	125	0.0270	0.0314	WP1	
N1265LC120	1200	1226	15000	1.125 x 10 <sup>6</sup>	0.883	0.297	125	0.0320	0.0388	W10	
○ N1265LC160	1600	1226	15000	1.125 x 10 <sup>6</sup>	0.883	0.297	125	0.0320	0.0388	W10	





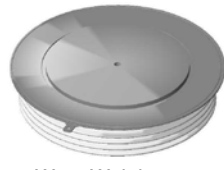



# Phase Control Thyristors

## Capsule Types

Type Part No. ○ Not for new design ➤ New	$V_{DRM}$ $V_{RRM}$	$I_{TAV}$ $T_K = 55^\circ\text{C}$	$I_{TSM}$ 10 ms $\frac{1}{2}$ sine $V_R \leq 60\% V_{RRM}$	$I^2t$ A <sup>2</sup> s	$V_{TO}$ @ $T_{JM}$	$r_T$ mΩ	$T_{JM}$ °C	$R_{thJC}$		Fig. No.	Package style  Outlines on pages O-01...O-29
	V	A	A	A <sup>2</sup> s	V			180° Sine K/W	120° Rect. K/W		
N1314NC300 † N1314NC360 †	3000 3600	1314	16600	$1.38 \times 10^6$	1.000	0.437	125	0.2200	0.0254	W11	
N1351VC400 N1351VC450 N1351VF400 N1351VF450	4000 4500 4000 4500	1351	17500	$1.53 \times 10^6$	1.200	0.553	125	0.0170	0.0200	W12 W12 W62 W62	
N1366JK080 N1366JK120 N1366JK140	800 1200 1400	1366	15900	$1.26 \times 10^6$	0.985	0.270	125	0.0270	0.0314	WP1 WP1 WP1	 W13 Weight 1700 g
N1449QL200 N1449QL220	2000 2200	1410	17300	$1.50 \times 10^6$	1.060	0.317	125	0.023	0.027	WP6 WP6	
N1467NC200 N1467NC260	2000 2600	1467	21500	$2.31 \times 10^6$	1.000	0.272	125	0.0240	0.0271	W11 W11	
➤ N1479NC24R ‡ ➤ N1479NC30R ‡	2400 3000	1436	21000	$2.21 \times 10^6$	1.000	0.342	125	0.0220	0.0255	W36 W36	 W14 Weight 1300 g
N1479NC240 † N1479NC300 †	2400 3000	1436	21000	$2.21 \times 10^6$	1.000	0.342	125	0.0220	0.0255	W11 W11	
N1547NC160 N1547NC200	1600 2000	1547	23300	$2.71 \times 10^6$	0.920	0.252	125	0.0240	0.0271	W11 W11	
N1581QL160 N1581QL180	1600 1800	1535	19100	$1.82 \times 10^6$	1.022	0.253	125	0.0230	0.0270	WP6 WP6	
N1588NC200 † N1588NC260 †	2000 2600	1588	22500	$2.53 \times 10^6$	0.951	0.268	125	0.0220	0.0255	W11 W11	 W15 Weight 2800 g
N1651QK200 N1651QK220	2000 2200	1651	17300	$1.50 \times 10^6$	1.060	0.317	125	0.0180	0.0217	WP2 WP2	
N1661VC300 N1661VC360 N1661VF300 N1661VF360	3000 3600 3000 3600	1661	23000	$2.65 \times 10^6$	1.040	0.350	125	0.0170	0.0200	W12 W12 W62 W62	
N1712VC240 N1712VC300 N1712VF240 N1712VF300	2400 3000 2400 3000	1712	24500	$3.00 \times 10^6$	1.050	0.320	125	0.0170	0.0200	W12 W12 W62 W62	 W36 Weight 500 g
N1718NC120 N1718NC180 N1718NC200	1200 1800 2000	1718	27200	$3.70 \times 10^6$	0.979	0.169	125	0.0240	0.0271	W11 W11 W11	
N1802NC120 N1802NC160	1200 1600	1802	29600	$4.38 \times 10^6$	0.855	0.171	125	0.0240	0.0271	W11 W11	
N1806QK160 N1806QK180	1600 1800	1806	19100	$1.82 \times 10^6$	1.022	0.253	125	0.0180	0.0217	WP2 WP2	 W46 Weight 1200 g * Available with reduced height 25mm, refer to Chippenham Factory
N1817QL080 N1817QL160 N1817QL180	800 1600 1800	1760	22000	$2.42 \times 10^6$	0.955	0.177	125	0.023	0.0272	WP6 WP6 WP6	
N2015ML200 N2015ML220	2000 2200	2015	32400	$5.25 \times 10^6$	0.883	0.210	125	0.0180	0.0201	WP5 WP5	
N2046NC120 † N2046NC160 †	1200 1600	2046	29200	$4.26 \times 10^6$	0.980	0.114	125	0.0220	0.0255	W11 W11	

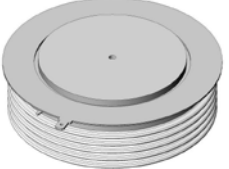
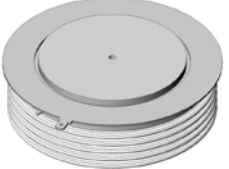
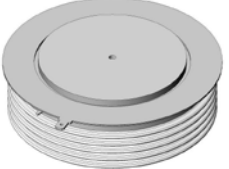

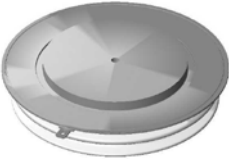
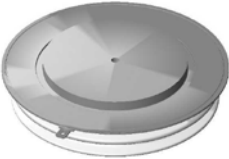
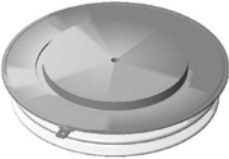





# Phase Control Thyristors

## Capsule Types

Type Part No. ○ Not for new design ➤ New	$V_{DRM}$ $V_{RRM}$ V	$I_{TAV}$ $T_K = 55^\circ C$ A	$I_{TSM}$ 10 ms ½ sine $V_R \leq 60\% V_{RRM}$ A	$I^2t$ A <sup>2</sup> s	$V_{TO}$   $r_T$ @ $T_{JM}$ V   mΩ		$T_{JM}$ °C	$R_{thJC}$ 180° Sine   120° Rect. K/W   K/W		Fig. No.	Package style  Outlines on pages O-01...O-29
N2083QK080	800	2083	22000	2.42 x 10 <sup>6</sup>	0.955	0.177	125	0.0180	0.0217	WP2	
N2083QK120	1200	2083	22000	2.42 x 10 <sup>6</sup>	0.955	0.177	125	0.0180	0.0217	WP2	
N2083QK140	1400	2083	22000	2.42 x 10 <sup>6</sup>	0.955	0.177	125	0.0180	0.0217	WP2	
N2086NC060	600	2086	35000	6.13 x 10 <sup>6</sup>	0.840	0.108	125	0.0240	0.0271	W11	
N2086NC100	1000	2086	35000	6.13 x 10 <sup>6</sup>	0.840	0.108	125	0.0240	0.0271	W11	
N2154JK020	200	2154	22700	2.58 x 10 <sup>6</sup>	0.890	0.107	140	0.0270	0.0314	WP1	
N2154JK040	400	2154	22700	2.58 x 10 <sup>6</sup>	0.890	0.107	140	0.0270	0.0314	WP1	
N2154JK060	600	2154	22700	2.58 x 10 <sup>6</sup>	0.890	0.107	140	0.0270	0.0314	WP1	
N2172ZC400	4000	2172	28000	3.92 x 10 <sup>6</sup>	1.350	0.294	125	0.0110	0.0120	W13	
N2172ZC450	4500	2172	28000	3.92 x 10 <sup>6</sup>	1.350	0.294	125	0.0110	0.0120	W13	
N2172ZD400	4000	2172	28000	3.92 x 10 <sup>6</sup>	1.350	0.294	125	0.0110	0.0120	W46	
N2172ZD450	4500	2172	28000	3.92 x 10 <sup>6</sup>	1.350	0.294	125	0.0110	0.0120	W46	
N2191ML160	1600	2191	34500	5.95 x 10 <sup>6</sup>	0.940	0.154	125	0.0180	0.0201	WP5	
N2191ML180	1800	2191	34500	5.95 x 10 <sup>6</sup>	0.940	0.154	125	0.0180	0.0201	WP5	
N2293VC180	1800	2293	33800	5.7 x 10 <sup>6</sup>	0.956	0.148	125	0.0170	0.0200	W12	
N2293VC220	2200	2293	33800	5.7 x 10 <sup>6</sup>	0.956	0.148	125	0.0170	0.0200	W12	
N2293VF180	1800	2293	33800	5.7 x 10 <sup>6</sup>	0.956	0.148	125	0.0170	0.0200	W62	
N2293VF220	2200	2293	33800	5.7 x 10 <sup>6</sup>	0.956	0.148	125	0.0170	0.0200	W62	
N2367MK200	2000	2367	32400	5.25 x 10 <sup>6</sup>	0.883	0.210	125	0.0140	0.0157	WP3	
N2367MK220	2200	2367	32400	5.25 x 10 <sup>6</sup>	0.883	0.210	125	0.0140	0.0157	WP3	
N2418ZC300	3000	2418	30000	4.50 x 10 <sup>6</sup>	1.160	0.246	125	0.0110	0.0120	W13	
N2418ZC360	3600	2418	30000	4.50 x 10 <sup>6</sup>	1.160	0.246	125	0.0110	0.0120	W13	
N2418ZD300	3000	2418	30000	4.50 x 10 <sup>6</sup>	1.160	0.246	125	0.0110	0.0120	W46	
N2418ZD360	3600	2418	30000	4.50 x 10 <sup>6</sup>	1.160	0.246	125	0.0110	0.0120	W46	
N2500VC120	1200	2500	37000	6.85 x 10 <sup>6</sup>	0.880	0.124	125	0.0170	0.0200	W12	
N2500VC160	1600	2500	37000	6.85 x 10 <sup>6</sup>	0.880	0.124	125	0.0170	0.0200	W12	
N2500VF120	1200	2500	37000	6.85 x 10 <sup>6</sup>	0.880	0.124	125	0.0170	0.0200	W62	
N2500VF160	1600	2500	37000	6.85 x 10 <sup>6</sup>	0.880	0.124	125	0.0170	0.0200	W62	
N2520ML080	800	2520	38200	7.30 x 10 <sup>6</sup>	0.980	0.090	125	0.0180	0.0201	WP5	
N2520ML120	1200	2520	38200	7.30 x 10 <sup>6</sup>	0.980	0.090	125	0.0180	0.0201	WP5	
N2520ML140	1400	2520	38200	7.30 x 10 <sup>6</sup>	0.980	0.090	125	0.0180	0.0201	WP5	
N2543ZC240	2400	2543	32000	5.12 x 10 <sup>6</sup>	0.780	0.274	125	0.0110	0.0120	W13	
N2543ZC300	3000	2543	32000	5.12 x 10 <sup>6</sup>	0.780	0.274	125	0.0110	0.0120	W13	
N2543ZD240	2400	2543	32000	5.12 x 10 <sup>6</sup>	0.780	0.274	125	0.0110	0.0120	W46	
N2543ZD300	3000	2543	32000	5.12 x 10 <sup>6</sup>	0.780	0.274	125	0.0110	0.0120	W46	
N2593MK160	1600	2593	34500	5.95 x 10 <sup>6</sup>	0.940	0.154	125	0.0140	0.0157	WP3	
N2593MK180	1800	2593	34500	5.95 x 10 <sup>6</sup>	0.940	0.154	125	0.0140	0.0157	WP3	
➤ N2825TE400	4000	2825	36900	6.81 x 10 <sup>6</sup>	1.210	0.270	125	0.008	0.00837	W82	
➤ N2825TE450	4500	2825	36900	6.81 x 10 <sup>6</sup>	1.210	0.270	125	0.008	0.00837	W82	
➤ N2825TJ400	4000	2825	36900	6.81 x 10 <sup>6</sup>	1.210	0.270	125	0.008	0.00837	W81	
➤ N2825TJ450	4500	2825	36900	6.81 x 10 <sup>6</sup>	1.210	0.270	125	0.008	0.00837	W81	
➤ N2900QL020	200	2900	28000	3.92 x 10 <sup>6</sup>	0.850	0.080	150	0.023	0.0272	WP6	
➤ N2900QL040	400	2900	28000	3.92 x 10 <sup>6</sup>	0.850	0.080	150	0.023	0.0272	WP6	
➤ N2900QL060	600	2900	28000	3.92 x 10 <sup>6</sup>	0.850	0.080	150	0.023	0.0272	WP6	
N3012ZC200	2000	3012	45100	10.2 x 10 <sup>6</sup>	0.920	0.160	125	0.0110	0.0120	W13	
N3012ZC260	2600	3012	45100	10.2 x 10 <sup>6</sup>	0.920	0.160	125	0.0110	0.0120	W13	
N3012ZD200	2000	3012	45100	10.2 x 10 <sup>6</sup>	0.920	0.160	125	0.0110	0.0120	W46	
N3012ZD260	2600	3012	45100	10.2 x 10 <sup>6</sup>	0.920	0.160	125	0.0110	0.0120	W46	

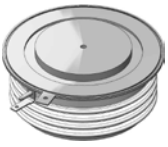
# Phase Control Thyristors







## Capsule Types

Type Part No. ○ Not for new design ➤ New	$V_{DRM}$ $V_{RRM}$	$I_{TAV}$ $T_K = 55^\circ\text{C}$	$I_{TSM}$	$I^2t$ 10 ms ½ sine $V_R \leq 60\% V_{RRM}$	$V_{TO}$	$r_T$ @ $T_{JM}$	$T_{JM}$	$R_{thJC}$		Fig. No.	Package style Outlines on pages O-01...O-29
	V	A	A	A <sup>2</sup> s	V	mΩ	°C	180° Sine K/W	120° Rect. K/W		
N3022MK080	800	3022	38200	7.30 x 10 <sup>6</sup>	0.981	0.090	125	0.0140	0.0157	WP3	
N3022MK120	1200	3022	38200	7.30 x 10 <sup>6</sup>	0.981	0.090	125	0.0140	0.0157	WP3	
N3022MK140	1400	3022	38200	7.30 x 10 <sup>6</sup>	0.981	0.090	125	0.0140	0.0157	WP3	
N3029ZC240	2400	3029	38200	7.30 x 10 <sup>6</sup>	0.947	0.154	125	0.0110	0.0119	W13	
N3029ZC280	2800	3029	38200	7.30 x 10 <sup>6</sup>	0.947	0.154	125	0.0110	0.0119	W13	
N3029ZD240	2400	3029	38200	7.30 x 10 <sup>6</sup>	0.947	0.154	125	0.0110	0.0119	W46	
N3029ZD280	2800	3029	38200	7.30 x 10 <sup>6</sup>	0.947	0.154	125	0.0110	0.0119	W46	
N3229QK020	200	3229	28000	3.92 x 10 <sup>6</sup>	0.926	0.067	140	0.0180	0.0217	WP2	W82 Weight 1650 g
N3229QK040	400	3229	28000	3.92 x 10 <sup>6</sup>	0.926	0.067	140	0.0180	0.0217	WP2	
N3229QK060	600	3229	28000	3.92 x 10 <sup>6</sup>	0.926	0.067	140	0.0180	0.0217	WP2	
○ N3493TC360	3600	3493	46800	10.95 x 10 <sup>6</sup>	0.950	0.180	125	0.008	0.012	W14	
○ N3493TC420	4200	3493	46800	10.95 x 10 <sup>6</sup>	0.950	0.180	125	0.008	0.012	W14	
○ N3493TD360	3600	3493	46800	10.95 x 10 <sup>6</sup>	0.950	0.180	125	0.008	0.012	W51	
○ N3493TD420	4200	3493	46800	10.95 x 10 <sup>6</sup>	0.950	0.180	125	0.008	0.012	W51	
N3533ZC180	1800	3533	50000	12.50 x 10 <sup>6</sup>	0.970	0.095	125	0.0110	0.0120	W13	W90 Weight 90 g
N3533ZC220	2200	3533	50000	12.50 x 10 <sup>6</sup>	0.970	0.095	125	0.0110	0.0120	W13	
N3533ZD180	1800	3533	50000	12.50 x 10 <sup>6</sup>	0.970	0.095	125	0.0110	0.0120	W46	
N3533ZD220	2200	3533	50000	12.50 x 10 <sup>6</sup>	0.970	0.095	125	0.0110	0.0120	W46	
N3597ML020	200	3597	45400	10.3 x 10 <sup>6</sup>	0.840	0.053	140	0.0180	0.0201	WP5	
N3597ML040	400	3597	45400	10.3 x 10 <sup>6</sup>	0.840	0.053	140	0.0180	0.0201	WP5	
N3597ML060	600	3597	45400	10.3 x 10 <sup>6</sup>	0.840	0.053	140	0.0180	0.0201	WP5	
➤ N3790TE240	2400	3790	49500	12.3 x 10 <sup>6</sup>	0.900	0.150	125	0.0080	0.00837	W82	W91 Weight 110 g
➤ N3790TE280	2800	3790	49500	12.3 x 10 <sup>6</sup>	0.900	0.150	125	0.0080	0.00837	W82	
➤ N3790TJ240	2400	3790	49500	12.3 x 10 <sup>6</sup>	0.900	0.150	125	0.0080	0.00837	W81	
➤ N3790TJ280	2800	3790	49500	12.3 x 10 <sup>6</sup>	0.900	0.150	125	0.0080	0.00837	W81	
N3839TC300	3000	3839	49500	12.25 x 10 <sup>6</sup>	0.950	0.140	125	0.008	0.0120	W14	
N3839TC350	3500	3839	49500	12.25 x 10 <sup>6</sup>	0.950	0.140	125	0.008	0.0120	W14	
N3839TD300	3000	3839	49500	12.25 x 10 <sup>6</sup>	0.950	0.140	125	0.008	0.0120	W51	
N3839TD350	3500	3839	49500	12.25 x 10 <sup>6</sup>	0.950	0.140	125	0.008	0.0120	W51	
N3880ZD160	1600	3880	59000	17.4 x 10 <sup>6</sup>	0.986	0.068	125	0.1100	0.1190	W46	W92 Weight 280 g
N3880ZD180	1800	3880	59000	17.4 x 10 <sup>6</sup>	0.986	0.068	125	0.1100	0.1190	W46	
N3904HK200	2000	3904	50900	12.95 x 10 <sup>6</sup>	0.920	0.111	125	0.0090	0.0099	WP4	
N3904HK220	2200	3904	50900	12.95 x 10 <sup>6</sup>	0.920	0.111	125	0.0090	0.0099	WP4	
N3930ZC120	1200	3930	54000	14.6 x 10 <sup>6</sup>	0.841	0.080	125	0.0110	0.0119	W13	WP1 Weight 180 g
N3930ZC160	1600	3930	54000	14.6 x 10 <sup>6</sup>	0.841	0.080	125	0.0110	0.0119	W13	
N3930ZD120	1200	3930	54000	14.6 x 10 <sup>6</sup>	0.841	0.080	125	0.0110	0.0119	W46	
N3930ZD160	1600	3930	54000	14.6 x 10 <sup>6</sup>	0.841	0.080	125	0.0110	0.0119	W46	
N4085ZC080	800	4085	64000	20.5 x 10 <sup>6</sup>	0.850	0.070	125	0.0110	0.0120	W13	
N4085ZC120	1200	4085	64000	20.5 x 10 <sup>6</sup>	0.850	0.070	125	0.0110	0.0120	W13	
N4085ZD080	800	4085	64000	20.5 x 10 <sup>6</sup>	0.850	0.070	125	0.0110	0.0120	W46	
N4085ZD120	1200	4085	64000	20.5 x 10 <sup>6</sup>	0.850	0.070	125	0.0110	0.0120	W46	
N4151FC360	3600	4151	54000	14.6 x 10 <sup>6</sup>	0.850	0.170	125	0.0065	0.0070	W15	
N4151FC420	4200	4151	54000	14.6 x 10 <sup>6</sup>	0.850	0.170	125	0.0065	0.0070	W15	
N4151FD360	3600	4151	54000	14.6 x 10 <sup>6</sup>	0.850	0.170	125	0.0065	0.0070	W48	
N4151FD420	4200	4151	54000	14.6 x 10 <sup>6</sup>	0.850	0.170	125	0.0065	0.0070	W48	
N4316MK020	200	4316	45400	10.3 x 10 <sup>6</sup>	0.840	0.053	140	0.0140	0.0157	WP3	WP3 Weight 260 g
N4316MK040	400	4316	45400	10.3 x 10 <sup>6</sup>	0.840	0.053	140	0.0140	0.0157	WP3	
N4316MK060	600	4316	45400	10.3 x 10 <sup>6</sup>	0.840	0.053	140	0.0140	0.0157	WP3	



# Phase Control Thyristors

## Capsule Types

Type Part No. ○ Not for new design ➤ New	$V_{DRM}$ $V_{RRM}$	$I_{TAV}$ $T_K = 55^\circ C$	$I_{TSM}$	$I^2t$ 10 ms ½ sine $V_R \leq 60\% V_{RRM}$	$V_{T0}$	$r_T$ @ $T_{JM}$	$T_{JM}$	$R_{thJC}$		Fig. No.	Package style  Outlines on pages O-01...O-29
	V	A	A	A <sup>2</sup> s	V	mΩ	°C	180° Sine K/W	120° Rect. K/W		
➤ N4340TE180	1800	4340	55000	15.1 x 10 <sup>6</sup>	0.886	0.105	125	0.008	0.00847	W82	 WP4 Weight 550 g
➤ N4340TE220	2200	4340	55000	15.1 x 10 <sup>6</sup>	0.886	0.105	125	0.008	0.00847	W82	
➤ N4340TJ180	1800	4340	55000	15.1 x 10 <sup>6</sup>	0.886	0.105	125	0.008	0.00847	W81	
➤ N4340TJ220	2200	4340	55000	15.1 x 10 <sup>6</sup>	0.886	0.105	125	0.008	0.00847	W81	
N4472HK160	1600	4472	59000	17.40 x 10 <sup>6</sup>	0.986	0.068	125	0.0090	0.0099	WP4	 WP4 Weight 550 g
N4472HK180	1800	4472	59000	17.40 x 10 <sup>6</sup>	0.986	0.068	125	0.0090	0.0099	WP4	
N4803FC300	3000	4803	60000	18.0 x 10 <sup>6</sup>	0.920	0.110	125	0.0065	0.0070	W15	 WP5 Weight 500 g
N4803FC350	3500	4803	60000	18.0 x 10 <sup>6</sup>	0.920	0.110	125	0.0065	0.0070	W15	
N4803FD300	3000	4803	60000	18.0 x 10 <sup>6</sup>	0.920	0.110	125	0.0065	0.0069	W48	
N4803FD350	3500	4803	60000	18.0 x 10 <sup>6</sup>	0.920	0.110	125	0.0065	0.0069	W48	
N5177FC200	2000	5177	67500	22.8 x 10 <sup>6</sup>	0.800	0.100	125	0.0065	0.0070	W15	 WP5 Weight 500 g
N5177FC280	2800	5177	67500	22.8 x 10 <sup>6</sup>	0.800	0.100	125	0.0065	0.0070	W15	
N5177FD200	2000	5177	67500	22.8 x 10 <sup>6</sup>	0.800	0.100	125	0.0065	0.0069	W48	
N5177FD280	2800	5177	67500	22.8 x 10 <sup>6</sup>	0.800	0.100	125	0.0065	0.0069	W48	
N5946FC180	1800	5946	72000	25.9 x 10 <sup>6</sup>	0.855	0.065	125	0.0065	0.0070	W15	 WP5 Weight 500 g
N5946FC220	2200	5946	72000	25.9 x 10 <sup>6</sup>	0.855	0.065	125	0.0065	0.0070	W15	
N5946FD180	1800	5946	72000	25.9 x 10 <sup>6</sup>	0.855	0.065	125	0.0065	0.0069	W48	
N5946FD220	2200	5946	72000	25.9 x 10 <sup>6</sup>	0.855	0.065	125	0.0065	0.0069	W48	
N6012ZD020	200	6012	65000	21.13 x 10 <sup>6</sup>	0.853	0.029	140	0.0110	0.0119	W46	 WP6 Weight 330 g
N6012ZD040	400	6012	65000	21.13 x 10 <sup>6</sup>	0.853	0.029	140	0.0110	0.0119	W46	
N6012ZD060	600	6012	65000	21.13 x 10 <sup>6</sup>	0.853	0.029	140	0.0110	0.0119	W46	
N6974HK020	200	6974	65000	21.13 x 10 <sup>6</sup>	0.853	0.029	140	0.0090	0.0099	WP4	 WP6 Weight 330 g
N6974HK040	400	6974	65000	21.13 x 10 <sup>6</sup>	0.853	0.029	140	0.0090	0.0099	WP4	
N6974HK060	600	6974	65000	21.13 x 10 <sup>6</sup>	0.853	0.029	140	0.0090	0.0099	WP4	

‡ - Thyristor for rotating applications - Please consult factory for more details

† - Please consult factory for new 56mm products to be introduced 2013/14

∅ - Not for series operation

# Medium Voltage Thyristors

Medium voltage applications place additional demands on phase controlled thyristors. To meet these demands we have developed a comprehensive range of thyristors optimised for medium voltage applications. As voltages increase, so do switching losses and turn-off time to a point where they become significant in line frequency applications. Our patented distributed gate architecture ensures excellent switching performance over a wide range of voltage, current and di/dt. Device lifetime is also engineered to achieve an optimum balance between conduction losses, commutation losses and turn-off time to give maximum power handling from line frequency to 400 Hz. This also gives significant benefits when series or parallel connection of devices is required. Medium voltage thyristors are available from 3.2 kV up to 6.5 kV with silicon diameters from 38 mm to 100 mm making them particularly suitable for high power converters such as medium voltage DC drives, medium voltage soft starts and utility applications such as HVDC, static VAR compensators, excitation and transfer switches.

We recognise the importance of reliability in these large, capital intensive applications and as a result we subject these parts to extended levels of both routine and type testing to ensure that your investment gives years of trouble free service.

## Capsule Types

Type Part No.	V <sub>DRM</sub> V <sub>RRM</sub>	I <sub>TAV</sub> T <sub>K</sub> = 55°C	I <sub>TSM</sub>	I <sup>2</sup> t 10 ms ½ sine V <sub>R</sub> ≤ 60% V <sub>RRM</sub>	t <sub>q</sub> @ 200 V/μs	Typ. Reverse Recovery Charge T <sub>JM</sub>			V <sub>TO</sub>	r <sub>T</sub>	T <sub>JM</sub>	R <sub>th,JK</sub>		L <sub>g</sub> No.
	V	A	A	A <sup>2</sup> s	μs	Q <sub>rr</sub> μC	@ I <sub>TM</sub> A	@ -di/dt A/μs	V	mΩ	°C	180° Sine K/W	120° Rect. K/W	
➤ <b>New</b>														
K0349LC600 †	6000	349	4800	115 x 10 <sup>3</sup>	900-1200	3100	1000	10	1.568	2.428	115	0.047	0.049	W10
K0349LC650 †	6500	349	4800	115 x 10 <sup>3</sup>	900-1200	3100	1000	10	1.568	2.428	115	0.047	0.049	W10
K0349LG600 †	6000	349	4800	115 x 10 <sup>3</sup>	900-1200	3100	1000	10	1.568	2.428	115	0.047	0.049	W56
K0349LG650 †	6500	349	4800	115 x 10 <sup>3</sup>	900-1200	3100	1000	10	1.568	2.428	115	0.047	0.049	W56
K0443LC600 †	6000	443	4800	115 x 10 <sup>3</sup>	900-1200	3100	1000	10	1.568	2.428	115	0.032	0.039	W10
K0443LC650 †	6500	443	4800	115 x 10 <sup>3</sup>	900-1200	3100	1000	10	1.568	2.428	115	0.032	0.039	W10
K0443LG600 †	6000	443	4800	115 x 10 <sup>3</sup>	900-1200	3100	1000	10	1.568	2.428	115	0.032	0.039	W56
K0443LG650 †	6500	443	4800	115 x 10 <sup>3</sup>	900-1200	3100	1000	10	1.568	2.428	115	0.032	0.039	W56
K0566LC440	4400	566	6000	180 x 10 <sup>3</sup>	700-1000	2200	500	10	1.360	1.790	125	0.032	0.039	W10
K0566LC480	4800	566	6000	180 x 10 <sup>3</sup>	700-1000	2200	500	10	1.360	1.790	125	0.032	0.039	W10
K0566LC520	5200	566	6000	180 x 10 <sup>3</sup>	700-1000	2200	500	10	1.360	1.790	125	0.032	0.039	W10
K0566LG440	4400	566	6000	180 x 10 <sup>3</sup>	700-1000	2200	500	10	1.360	1.790	125	0.032	0.039	W56
K0566LG480	4800	566	6000	180 x 10 <sup>3</sup>	700-1000	2200	500	10	1.360	1.790	125	0.032	0.039	W56
K0566LG520	5200	566	6000	180 x 10 <sup>3</sup>	700-1000	2200	500	10	1.360	1.790	125	0.032	0.039	W56
➤ K0620QA600 †	6000	620	7250	263 x 10 <sup>3</sup>	700-1000	4000	2000	10	1.540	1.450	125	0.030	0.037	W75
➤ K0620QA650 †	6500	620	7250	263 x 10 <sup>3</sup>	700-1000	4000	2000	10	1.540	1.450	125	0.030	0.037	W75
➤ K0620QE600 †	6000	620	7250	263 x 10 <sup>3</sup>	700-1000	4000	2000	10	1.540	1.450	125	0.030	0.037	W76
➤ K0620QE650 †	6500	620	7250	263 x 10 <sup>3</sup>	700-1000	4000	2000	10	1.540	1.450	125	0.030	0.037	W76
K0682LC360	3600	682	6350	202 x 10 <sup>3</sup>	650-800	2000	1000	10	1.211	1.182	125	0.032	0.039	W10
K0682LC420	4200	682	6350	202 x 10 <sup>3</sup>	650-800	2000	1000	10	1.211	1.182	125	0.032	0.039	W10
K0682LG360	3600	682	6350	202 x 10 <sup>3</sup>	650-800	2000	1000	10	1.211	1.182	125	0.032	0.039	W56
K0682LG420	4200	682	6350	202 x 10 <sup>3</sup>	650-800	2000	1000	10	1.211	1.182	125	0.032	0.039	W56
K0769NC600 †	6000	769	8600	370 x 10 <sup>3</sup>	900-1200	3100	1000	10	1.566	1.172	115	0.024	0.029	W11
K0769NC650 †	6500	769	8600	370 x 10 <sup>3</sup>	900-1200	3100	1000	10	1.566	1.172	115	0.024	0.029	W11
K0769NG600 †	6000	769	8600	370 x 10 <sup>3</sup>	900-1200	3100	1000	10	1.566	1.172	115	0.024	0.029	W57
K0769NG650 †	6500	769	8600	370 x 10 <sup>3</sup>	900-1200	3100	1000	10	1.566	1.172	115	0.024	0.029	W57
K0885NC450	4500	885	10000	500 x 10 <sup>3</sup>	700-1100	5300	1000	10	1.270	0.930	125	0.024	0.027	W11
K0885NC480	4800	885	10000	500 x 10 <sup>3</sup>	700-1100	5300	1000	10	1.270	0.930	125	0.024	0.027	W11
K0885NC520	5200	885	10000	500 x 10 <sup>3</sup>	700-1100	5300	1000	10	1.270	0.930	125	0.024	0.027	W11
K0885NG450	4500	885	10000	500 x 10 <sup>3</sup>	700-1100	5300	1000	10	1.270	0.930	125	0.024	0.027	W57
K0885NG480	4800	885	10000	500 x 10 <sup>3</sup>	700-1100	5300	1000	10	1.270	0.930	125	0.024	0.027	W57
K0885NG520	5200	885	10000	500 x 10 <sup>3</sup>	700-1100	5300	1000	10	1.270	0.930	125	0.024	0.027	W57
K0890NC360	3600	890	10900	594 x 10 <sup>3</sup>	350-550	4000	1000	10	1.516	0.800	125	0.024	0.029	W11
K0890NC420	4200	890	10900	594 x 10 <sup>3</sup>	350-550	4000	1000	10	1.516	0.800	125	0.024	0.029	W11
➤ K1000MA600 †	6000	1000	12500	781 x 10 <sup>3</sup>	700-1000	6500	2000	10	1.390	0.860	125	0.020	0.022	W77
➤ K1000MA650 †	6500	1000	12500	781 x 10 <sup>3</sup>	700-1000	6500	2000	10	1.390	0.860	125	0.020	0.022	W77
➤ K1000ME600 †	6000	1000	12500	781 x 10 <sup>3</sup>	700-1000	6500	2000	10	1.390	0.860	125	0.020	0.022	W78
➤ K1000ME650 †	6500	1000	12500	781 x 10 <sup>3</sup>	700-1000	6500	2000	10	1.390	0.860	125	0.020	0.022	W78
K1120NC360	3600	1120	13500	911 x 10 <sup>3</sup>	650-1000	5000	1000	10	1.092	0.546	125	0.024	0.027	W11
K1120NC420	4200	1120	13500	911 x 10 <sup>3</sup>	650-1000	5000	1000	10	1.092	0.546	125	0.024	0.027	W11
K1120NG360	3600	1120	13500	911 x 10 <sup>3</sup>	650-1000	5000	1000	10	1.092	0.546	125	0.024	0.027	W57
K1120NG420	4200	1120	13500	911 x 10 <sup>3</sup>	650-1000	5000	1000	10	1.092	0.546	125	0.024	0.027	W57
K1121NC320	3200	1121	15000	1.13 x 10 <sup>6</sup>	200-300	2000	1000	10	1.098	0.542	125	0.024	0.029	W11
K1121NC360	3600	1121	15000	1.13 x 10 <sup>6</sup>	200-300	2000	1000	10	1.098	0.542	125	0.024	0.029	W11
K1197NC300	3000	1197	10650	567 x 10 <sup>3</sup>	200-300	2700	1000	10	1.335	0.372	125	0.024	0.029	W11
K1197NC320	3200	1197	10650	567 x 10 <sup>3</sup>	200-300	2700	1000	10	1.335	0.372	125	0.024	0.029	W11
K1351VC600 †	6000	1351	14300	1.02 x 10 <sup>6</sup>	800-1500	7200	2000	10	1.410	0.600	115	0.013	0.015	W12
K1351VC650 †	6500	1351	14300	1.02 x 10 <sup>6</sup>	800-1500	7200	2000	10	1.410	0.600	115	0.013	0.015	W12
K1351VF600 †	6000	1351	14300	1.02 x 10 <sup>6</sup>	800-1500	7200	2000	10	1.410	0.600	115	0.013	0.015	W62
K1351VF650 †	6500	1351	14300	1.02 x 10 <sup>6</sup>	800-1500	7200	2000	10	1.410	0.600	115	0.013	0.015	W62
K1947ZC400	4000	1947	25000	3.13 x 10 <sup>6</sup>	600-700	8800	1000	10	1.221	0.425	125	0.011	0.012	W13
K1947ZC450	4500	1947	25000	3.13 x 10 <sup>6</sup>	600-700	8800	1000	10	1.221	0.425	125	0.011	0.012	W13
K1947ZD400	4000	1947	25000	3.13 x 10 <sup>6</sup>	600-700	8800	1000	10	1.221	0.425	125	0.011	0.012	W46
K1947ZD450	4500	1947	25000	3.13 x 10 <sup>6</sup>	600-700	8800	1000	10	1.221	0.425	125	0.011	0.012	W46

# Medium Voltage Thyristors

## Capsule Types

Type Part No. ➤ New	$V_{DRM}$ $V_{RRM}$ V	$I_{TAV}$ $T_K = 55^\circ C$ A	$I_{TSM}$ 10 ms 1/2 sine $V_R \leq 60\% V_{RRM}$ A	$I^2t$ A <sup>2</sup> s	$t_q$ @ 200 V/ $\mu$ s $\mu$ s	Typ. Reverse Recovery Charge			$V_{T0}$ V	$r_T$ @ $T_{JM}$ m $\Omega$	$T_{JM}$ °C	$R_{thJK}$		Fig. No.
						$Q_{rr}$ $\mu$ C	$T_{JM}$ @ $I_{TM}$ A	@ -di/dt A/ $\mu$ s				180° Sine K/W	120° Rect. K/W	
K2065VC360	3600	2065	28000	$3.92 \times 10^6$	400-700	6700	2000	10	1.121	0.291	125	0.013	0.015	W12
K2065VC420	4200	2065	28000	$3.92 \times 10^6$	400-700	6700	2000	10	1.121	0.291	125	0.013	0.015	W12
K2065VF360	3600	2065	28000	$3.92 \times 10^6$	400-700	6700	2000	10	1.121	0.291	125	0.013	0.015	W62
K2065VF420	4200	2065	28000	$3.92 \times 10^6$	400-700	6700	2000	10	1.121	0.291	125	0.013	0.015	W62
K2095ZC360	3600	2095	18200	$1.66 \times 10^6$	400-500	4550	2000	10	1.502	0.296	125	0.011	0.012	W13
K2095ZC420	4200	2095	18200	$1.66 \times 10^6$	400-500	4550	2000	10	1.502	0.296	125	0.011	0.012	W13
K2095ZD360	3600	2095	18200	$1.66 \times 10^6$	400-500	4550	2000	10	1.502	0.296	125	0.011	0.012	W46
K2095ZD420	4200	2095	18200	$1.66 \times 10^6$	400-500	4550	2000	10	1.502	0.296	125	0.011	0.012	W46
K2359TC600 †	6000	2359	27000	$3.65 \times 10^6$	1100-1500	11500	2000	10	1.391	0.360	115	0.009	0.009	W14
K2359TC650 †	6500	2359	27000	$3.65 \times 10^6$	1100-1500	11500	2000	10	1.391	0.360	115	0.009	0.009	W14
K2359TD600 †	6000	2359	27000	$3.65 \times 10^6$	1100-1500	11500	2000	10	1.391	0.360	115	0.009	0.009	W51
K2359TD650 †	6500	2359	27000	$3.65 \times 10^6$	1100-1500	11500	2000	10	1.391	0.360	115	0.009	0.009	W51
K2623TC450	4500	2623	27000	$3.65 \times 10^6$	500-1000	6800	2000	10	1.421	0.295	125	0.008	0.009	W14
K2623TC480	4800	2623	27000	$3.65 \times 10^6$	500-1000	6800	2000	10	1.421	0.295	125	0.008	0.009	W14
K2623TC520	5200	2623	27000	$3.65 \times 10^6$	500-1000	6800	2000	10	1.421	0.295	125	0.008	0.009	W14
K2623TD450	4500	2623	27000	$3.65 \times 10^6$	500-1000	6800	2000	10	1.421	0.295	125	0.008	0.009	W51
K2623TD480	4800	2623	27000	$3.65 \times 10^6$	500-1000	6800	2000	10	1.421	0.295	125	0.008	0.009	W51
K2623TD520	5200	2623	27000	$3.65 \times 10^6$	500-1000	6800	2000	10	1.421	0.295	125	0.008	0.009	W51
K2960TC450	4500	2960	32500	$5.28 \times 10^6$	800-1600	17000	4000	10	1.229	0.212	125	0.009	0.009	W14
K2960TC480	4800	2960	32500	$5.28 \times 10^6$	800-1600	17000	4000	10	1.229	0.212	125	0.009	0.009	W14
K2960TC520	5200	2960	32500	$5.28 \times 10^6$	800-1600	17000	4000	10	1.229	0.212	125	0.009	0.009	W14
K2960TD450	4500	2960	32500	$5.28 \times 10^6$	800-1600	17000	4000	10	1.229	0.212	125	0.009	0.009	W51
K2960TD480	4800	2960	32500	$5.28 \times 10^6$	800-1600	17000	4000	10	1.229	0.212	125	0.009	0.009	W51
K2960TD520	5200	2960	32500	$5.28 \times 10^6$	800-1600	17000	4000	10	1.229	0.212	125	0.009	0.009	W51
K2973FC600	6000	2973	35400	$6.27 \times 10^6$	1100-1500	15000	4000	10	1.581	0.207	115	0.007	0.007	W15
K2973FC650	6500	2973	35400	$6.27 \times 10^6$	1100-1500	15000	4000	10	1.581	0.207	115	0.007	0.007	W15
K2973FD600	6000	2973	35400	$6.27 \times 10^6$	1100-1500	15000	4000	10	1.581	0.207	115	0.007	0.007	W48
K2973FD650	6500	2973	35400	$6.27 \times 10^6$	1100-1500	15000	4000	10	1.581	0.207	115	0.007	0.007	W48
K3207EC450	4500	3207	32500	$5.28 \times 10^6$	800-1600	17000	4000	10	1.229	0.212	125	0.008	0.008	W55
K3207EC480	4800	3207	32500	$5.28 \times 10^6$	800-1600	17000	4000	10	1.229	0.212	125	0.008	0.008	W55
K3207EC520	5200	3207	32500	$5.28 \times 10^6$	800-1600	17000	4000	10	1.229	0.212	125	0.008	0.008	W55
K3362TC360	3600	3362	39500	$7.80 \times 10^6$	1000-2000	12000	4000	10	1.052	0.168	125	0.009	0.009	W14
K3362TC420	4200	3362	39500	$7.80 \times 10^6$	1000-2000	12000	4000	10	1.052	0.168	125	0.009	0.009	W14
K3362TD360	3600	3362	39500	$7.80 \times 10^6$	1000-2000	12000	4000	10	1.052	0.168	125	0.009	0.009	W51
K3362TD420	4200	3362	39500	$7.80 \times 10^6$	1000-2000	12000	4000	10	1.052	0.168	125	0.009	0.009	W51
K3503FC450	4500	3503	43200	$9.33 \times 10^6$	900-1800	8000	4000	10	1.375	0.196	125	0.007	0.007	W15
K3503FC480	4800	3503	43200	$9.33 \times 10^6$	900-1800	8000	4000	10	1.375	0.196	125	0.007	0.007	W15
K3503FC520	5200	3503	43200	$9.33 \times 10^6$	900-1800	8000	4000	10	1.375	0.196	125	0.007	0.007	W15
K3503FD450	4500	3503	43200	$9.33 \times 10^6$	900-1800	8000	4000	10	1.375	0.196	125	0.007	0.007	W48
K3503FD480	4800	3503	43200	$9.33 \times 10^6$	900-1800	8000	4000	10	1.375	0.196	125	0.007	0.007	W48
K3503FD520	5200	3503	43200	$9.33 \times 10^6$	900-1800	8000	4000	10	1.375	0.196	125	0.007	0.007	W48

† - New 6.5kV alternative alloyed parts in development, please consult factory for more details



Outlines on pages  
O-01...O-29



W10 Weight 340 g



W12 Weight 1000 g



W13 Weight 1700 g



W11 Weight 510 g



W14 Weight 1300 g



W15 Weight 2800 g

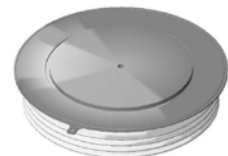

W46 Weight 1200 g



W48 Weight 2000 g

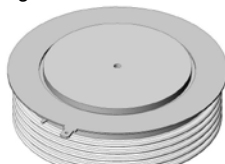

W51 Weight 1700 g



W55 Weight 1800 g

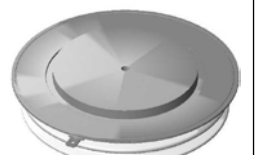





W62 Weight 1000 g

# Fast Turn Off Thyristors

IXYS UK Westcode Ltd's "P" series of fast switching thyristors have regenerative gate structure to ensure low switching losses and high di/dt performance. "P" Series devices are suitable for existing inverter, DC chopper drives, UPS and Pulse Power applications. In addition to pressure contact technology these devices offer lower reverse recovery charge values, low forward switching losses and high reliability. These devices are not recommended for new designs.

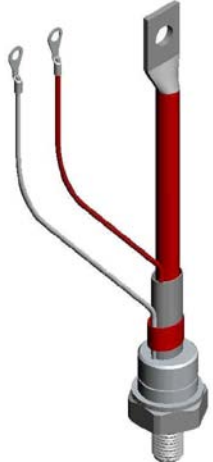







## Stud Types

Type Part No.	$V_{DRM}$ $V_{RRM}$	$I_{TAV}$ $T_C = 55^\circ C$	$I_{TSM}$	$I^2t$ 10 ms 1/2 sine $V_R \leq 60\% V_{RRM}$	$t_q$ @ 200 V/ $\mu s$	Typ. Reverse Recovery Charge $T_{JM}$			$V_{TO}$	$r_T$ @ $T_{JM}$	$R_{thJC}$ 180° sine	Fig. No.	Package style Outlines on pages O-01...O-29
	V	A	A	A <sup>2</sup> s	$\mu s$	$Q_{rr}$ $\mu C$	@ $I_{TM}$ A	@ -di/dt A/ $\mu s$	V	m $\Omega$	K/W		
P0128SH10C	1000	128	1700	19 x 10 <sup>3</sup>	15	50	100	10	1.600	2.490	0.2300	W17	  W16 Weight 100 g  W17 Weight 130 g  W18 Weight 280 g
P0128SH10D	1000	128	1700	19 x 10 <sup>3</sup>	20	50	100	10	1.600	2.490	0.2300	W17	
P0128SH10E	1000	128	1700	19 x 10 <sup>3</sup>	25	50	100	10	1.600	2.490	0.2300	W17	
P0128SH12C	1200	128	1700	19 x 10 <sup>3</sup>	15	50	100	10	1.600	2.490	0.2300	W17	
P0128SH12D	1200	128	1700	19 x 10 <sup>3</sup>	20	50	100	10	1.600	2.490	0.2300	W17	
P0128SH12E	1200	128	1700	19 x 10 <sup>3</sup>	25	50	100	10	1.600	2.490	0.2300	W17	
P0128SJ10C	1000	128	1700	19 x 10 <sup>3</sup>	15	50	100	10	1.600	2.490	0.2300	W16	
P0128SJ10D	1000	128	1700	19 x 10 <sup>3</sup>	20	50	100	10	1.600	2.490	0.2300	W16	
P0128SJ10E	1000	128	1700	19 x 10 <sup>3</sup>	25	50	100	10	1.600	2.490	0.2300	W16	
P0128SJ12C	1200	128	1700	19 x 10 <sup>3</sup>	15	50	100	10	1.600	2.490	0.2300	W16	
P0128SJ12D	1200	128	1700	19 x 10 <sup>3</sup>	20	50	100	10	1.600	2.490	0.2300	W16	
P0128SJ12E	1200	128	1700	19 x 10 <sup>3</sup>	25	50	100	10	1.600	2.490	0.2300	W16	
P0248SC12D	1200	248	2700	36.5 x 10 <sup>3</sup>	20	45	300	20	1.600	1.230	0.1200	W18	
P0248SC12E	1200	248	2700	36.5 x 10 <sup>3</sup>	25	45	300	20	1.600	1.230	0.1200	W18	
P0273SC12D	1200	273	3250	52.8 x 10 <sup>3</sup>	20	80	300	20	1.550	0.870	0.1200	W18	
P0273SC12E	1200	273	3250	52.8 x 10 <sup>3</sup>	25	80	300	20	1.550	0.870	0.1200	W18	
P0273SC12F	1200	273	3250	52.8 x 10 <sup>3</sup>	30	80	300	20	1.550	0.870	0.1200	W18	
P0306SC08A	800	306	4700	110 x 10 <sup>3</sup>	10	50	300	20	1.400	0.670	0.1200	W18	
P0306SC08B	800	306	4700	110 x 10 <sup>3</sup>	12	50	300	20	1.400	0.670	0.1200	W18	
P0306SC08C	800	306	4700	110 x 10 <sup>3</sup>	15	50	300	20	1.400	0.670	0.1200	W18	
P0311SC12E	1200	311	3600	64.8 x 10 <sup>3</sup>	25	55	300	20	1.170	0.920	0.1200	W18	
P0311SC12F	1200	311	3600	64.8 x 10 <sup>3</sup>	30	55	300	20	1.170	0.920	0.1200	W18	
P0330SC04A	400	330	5000	125 x 10 <sup>3</sup>	10	55	300	20	1.050	0.880	0.1200	W18	
P0330SC04C	400	330	5000	125 x 10 <sup>3</sup>	15	55	300	20	1.050	0.880	0.1200	W18	
P0330SC06A	600	330	5000	125 x 10 <sup>3</sup>	10	55	300	20	1.050	0.880	0.1200	W18	
P0330SC06C	600	330	5000	125 x 10 <sup>3</sup>	20	55	300	20	1.050	0.880	0.1200	W18	
P0330SC08A	800	330	5000	125 x 10 <sup>3</sup>	10	55	300	20	1.050	0.880	0.1200	W18	
P0330SC08C	800	330	5000	125 x 10 <sup>3</sup>	15	55	300	20	1.050	0.880	0.1200	W18	
P0431SC04B	400	431	6500	211 x 10 <sup>3</sup>	12	190	300	20	0.950	0.377	0.1200	W18	
P0431SC04C	400	431	6500	211 x 10 <sup>3</sup>	15	190	300	20	0.950	0.377	0.1200	W18	
P0431SC06B	600	431	6500	211 x 10 <sup>3</sup>	12	190	300	20	0.950	0.377	0.1200	W18	
P0431SC06C	600	431	6500	211 x 10 <sup>3</sup>	15	190	300	20	0.950	0.377	0.1200	W18	

$T_{JM} = 125^\circ C$

# Fast Turn Off Thyristors

## Capsule Types







Type Part No.	$V_{DRM}$ $V_{RRM}$ V	$I_{TAV}$ $T_C = 55^\circ\text{C}$ A	$I_{TSM}$ A	$I^2t$ 10 ms ½ sine $V_R \leq 60\% V_{RRM}$ A <sup>2</sup> s	$t_q$ @ 200 V/ $\mu$ s $\mu$ s	Typ. Reverse Recovery Charge $T_{JM}$ $Q_{rr}$ @ $I_{TM}$ @ -di/dt $\mu$ C A A/ $\mu$ s			$V_{TO}$ @ $T_{JM}$ V	$r_T$ @ $T_{JM}$ m $\Omega$	$R_{thJC}$ 180° sine K/W	Fig. No.	Package style Outlines on pages O-01...O-29
P0295WC12D	1200	295	2700	36.5 x 10 <sup>3</sup>	20	50	300	20	1.600	1.230	0.0950	W8	
P0295WC12E	1200	295	2700	36.5 x 10 <sup>3</sup>	25	50	300	20	1.600	1.230	0.0950	W8	
P0327WC08C	800	327	3250	63.9 x 10 <sup>3</sup>	20	45	300	20	1.550	0.870	0.0950	W8	 W8 Weight 70 g
P0327WC08D	800	327	3250	63.9 x 10 <sup>3</sup>	20	45	300	20	1.550	0.870	0.0950	W8	
P0327WC08E	800	327	3250	63.9 x 10 <sup>3</sup>	25	45	300	20	1.550	0.870	0.0950	W8	
P0327WC08F	800	327	3250	63.9 x 10 <sup>3</sup>	30	45	300	20	1.550	0.870	0.0950	W8	
P0327WC12C	1200	327	3250	63.9 x 10 <sup>3</sup>	20	45	300	20	1.550	0.870	0.0950	W8	
P0327WC12D	1200	327	3250	63.9 x 10 <sup>3</sup>	20	45	300	20	1.550	0.870	0.0950	W8	
P0327WC12E	1200	327	3250	63.9 x 10 <sup>3</sup>	25	45	300	20	1.550	0.870	0.0950	W8	
P0327WC12F	1200	327	3250	63.9 x 10 <sup>3</sup>	30	45	300	20	1.550	0.870	0.0950	W8	
P0366WC04A	400	366	4700	110 x 10 <sup>3</sup>	10	25	300	20	1.400	0.670	0.0950	W8	
P0366WC04B	400	366	4700	110 x 10 <sup>3</sup>	12	25	300	20	1.400	0.670	0.0950	W8	
P0366WC04C	400	366	4700	110 x 10 <sup>3</sup>	15	25	300	20	1.400	0.670	0.0950	W8	
P0366WC06A	600	366	4700	110 x 10 <sup>3</sup>	10	25	300	20	1.400	0.670	0.0950	W8	
P0366WC06B	600	366	4700	110 x 10 <sup>3</sup>	12	25	300	20	1.400	0.670	0.0950	W8	
P0366WC06C	600	366	4700	110 x 10 <sup>3</sup>	15	25	300	20	1.400	0.670	0.0950	W8	
P0366WC08A	800	366	4700	110 x 10 <sup>3</sup>	10	25	300	20	1.400	0.670	0.0950	W8	
P0366WC08B	800	366	4700	110 x 10 <sup>3</sup>	12	25	300	20	1.400	0.670	0.0950	W8	
P0366WC08C	800	366	4700	110 x 10 <sup>3</sup>	15	25	300	20	1.400	0.670	0.0950	W8	
P0367WC12E	1200	367	3600	64.8 x 10 <sup>3</sup>	25	50	300	20	1.170	0.920	0.0950	W8	 W8 Weight 90 g
P0367WC12F	1200	367	3600	64.8 x 10 <sup>3</sup>	30	50	300	20	1.170	0.920	0.0950	W8	
P0389WC04B	400	389	5000	125 x 10 <sup>3</sup>	12	30	300	20	1.050	0.880	0.0950	W8	 W9 Weight 90 g
P0389WC04C	400	389	5000	125 x 10 <sup>3</sup>	15	30	300	20	1.050	0.880	0.0950	W8	
P0389WC08B	800	389	5000	125 x 10 <sup>3</sup>	12	30	300	20	1.050	0.880	0.0950	W8	
P0389WC08C	800	389	5000	125 x 10 <sup>3</sup>	15	30	300	20	1.050	0.880	0.0950	W8	
P0515WC04B	400	515	6500	211 x 10 <sup>3</sup>	15	180	300	20	0.950	0.377	0.0950	W8	 W8 Weight 90 g
P0515WC04C	400	515	6500	211 x 10 <sup>3</sup>	15	180	300	20	0.950	0.377	0.0950	W8	
P0515WC04D	400	515	6500	211 x 10 <sup>3</sup>	20	180	300	20	0.950	0.377	0.0950	W8	
P0515WC06B	600	515	6500	211 x 10 <sup>3</sup>	15	180	300	20	0.950	0.377	0.0950	W8	
P0515WC06C	600	515	6500	211 x 10 <sup>3</sup>	15	180	300	20	0.950	0.377	0.0950	W8	
P0515WC06D	600	515	6500	211 x 10 <sup>3</sup>	20	180	300	20	0.950	0.377	0.0950	W8	
P0838LC06B	600	839	12300	750 x 10 <sup>3</sup>	12	160	800	50	1.200	0.280	0.0470	W10	 W10 Weight 340 g
P0838LC06C	600	836	12300	750 x 10 <sup>3</sup>	15	160	800	50	1.200	0.280	0.0470	W10	
P0848YS04B	400	848	8750	383 x 10 <sup>3</sup>	12	200	550	40	1.010	0.305	0.0500	W9	 W9 Weight 90 g
P0848YS04C	400	848	8750	383 x 10 <sup>3</sup>	15	200	550	40	1.010	0.305	0.0500	W9	
P0848YS06B	600	848	8750	383 x 10 <sup>3</sup>	12	200	550	40	1.010	0.305	0.0500	W9	
P0848YS06C	600	848	8750	383 x 10 <sup>3</sup>	15	200	550	40	1.010	0.305	0.0500	W9	
P1007LC08D	800	1007	9500	451 x 10 <sup>3</sup>	20	400	800	50	1.509	0.265	0.0320	W10	
P1007LC08E	800	1007	9500	451 x 10 <sup>3</sup>	25	400	800	50	1.509	0.265	0.0320	W10	
P1007LC08F	800	1007	9500	451 x 10 <sup>3</sup>	30	400	800	50	1.509	0.265	0.0320	W10	
P1007LC12D	1200	1007	9500	451 x 10 <sup>3</sup>	20	400	800	50	1.509	0.265	0.0320	W10	 W10 Weight 340 g
P1007LC12E	1200	1007	9500	451 x 10 <sup>3</sup>	25	400	800	50	1.509	0.265	0.0320	W10	
P1007LC12F	1200	1007	9500	451 x 10 <sup>3</sup>	30	400	800	50	1.509	0.265	0.0320	W10	

$T_{JM} = 125^\circ\text{C}$

# Distributed Gate Thyristors





















IXYS UK Westcode Ltd is recognised as the Worldwide leader in distributed gate technology. These devices are available with blocking voltages to 4.5kV and average current to 4kA, with  $t_q$  from 10 to 300 $\mu$ s. The unique distributed gate design and lifetime control features give these devices both high di/dt capability and fast, low recovery turn-off, while maintaining a low on-state voltage drop. Ideally suited to application including: induction power supplies, high frequency inverters/converters, UPS and pulse power.

## Capsule Types

Type Part No.	$V_{DRM}$ V	$V_{RRM}$ V	$I_{TAV}$ A $T_K = 55^\circ C$	$I_{TSM}$ A	$I^2t$ 10 ms 1/2 sine $V_R \leq 60\% V_{RRM}$ A <sup>2</sup> s	$t_q$ @ 200 V/ $\mu$ s $\mu$ s	Typ. Reverse Recovery Charge			$V_{TO}$ V	$r_T$ @ $T_{JM}$ m $\Omega$	$R_{thJK}$ 180° Sine K/W	Fig. No.	Package style Outlines on pages O-01...O-29
							$Q_{rr}$ @ $T_{JM}$ $\mu$ C	@ $I_{TM}$ A	@-di/dt A/ $\mu$ s					
➤ <b>R0472YS12E</b>	1200	1200	472	4300	92.5 x 10 <sup>3</sup>	25	155	550	40	1.648	1.125	0.050	W9	
<b>R0472YS12F</b>	1200	1200	472	4300	92.5 x 10 <sup>3</sup>	30	155	550	40	1.648	1.125	0.050	W9	
<b>R0472YS16E</b>	1600	1600	472	4300	92.5 x 10 <sup>3</sup>	25	155	550	40	1.648	1.125	0.050	W9	
<b>R0472YS16F</b>	1600	1600	472	4300	92.5 x 10 <sup>3</sup>	30	155	550	40	1.648	1.125	0.050	W9	
<b>R0487YS12D</b>	1200	1200	487	4300	92.5 x 10 <sup>3</sup>	20	90	550	40	1.738	0.943	0.0500	W9	
<b>R0487YS12E</b>	1200	1200	487	4300	92.5 x 10 <sup>3</sup>	25	90	550	40	1.738	0.943	0.0500	W9	
<b>R0487YS14D</b>	1400	1400	487	4300	92.5 x 10 <sup>3</sup>	20	90	550	40	1.738	0.943	0.0500	W9	
<b>R0487YS14E</b>	1400	1400	487	4300	92.5 x 10 <sup>3</sup>	25	90	550	40	1.738	0.943	0.0500	W9	
<b>R0577YS12C</b>	1200	1200	577	6000	180 x 10 <sup>3</sup>	15	150	550	40	1.510	0.640	0.0500	W9	
<b>R0577YS12D</b>	1200	1200	577	6000	180 x 10 <sup>3</sup>	20	150	550	40	1.510	0.640	0.0500	W9	
<b>R0577YS12E</b>	1200	1200	577	6000	180 x 10 <sup>3</sup>	25	150	550	40	1.510	0.640	0.0500	W9	
<b>R0633YS12D</b>	1200	1200	633	6300	200 x 10 <sup>3</sup>	20	125	550	40	1.250	0.614	0.0500	W9	
<b>R0633YS12E</b>	1200	1200	633	6300	200 x 10 <sup>3</sup>	25	125	550	40	1.250	0.614	0.0500	W9	
<b>R0633YS12F</b>	1200	1200	633	6300	200 x 10 <sup>3</sup>	30	125	550	40	1.250	0.614	0.0500	W9	
<b>R0717LC14G</b>	1400	1400	717	7050	248.5 x 10 <sup>3</sup>	35	425	1000	60	1.752	0.732	0.0320	W10	
➤ <b>R0717LC18G</b>	1800	1800	717	7050	248.5 x 10 <sup>3</sup>	35	425	1000	60	1.752	0.732	0.0320	W10	
<b>R0736LC20J</b>	2000	2000	736	6800	231 x 10 <sup>3</sup>	50	640	1000	60	1.842	0.619	0.0320	W10	
<b>R0736LC20K</b>	2000	2000	736	6800	231 x 10 <sup>3</sup>	60	640	1000	60	1.842	0.619	0.0320	W10	
<b>R0736LC22J</b>	2200	2200	736	6800	231 x 10 <sup>3</sup>	50	640	1000	60	1.842	0.619	0.0320	W10	
<b>R0736LC22K</b>	2200	2200	736	6800	231 x 10 <sup>3</sup>	60	640	1000	60	1.842	0.619	0.0320	W10	
<b>R0736LC25J</b>	2500	2500	736	6800	231 x 10 <sup>3</sup>	50	640	1000	60	1.842	0.619	0.0320	W10	
<b>R0736LC25K</b>	2500	2500	736	6800	231 x 10 <sup>3</sup>	60	640	1000	60	1.842	0.619	0.0320	W10	
<b>R0736LC25L</b>	2500	2500	736	6800	231 x 10 <sup>3</sup>	65	640	1000	60	1.842	0.619	0.0320	W10	
<b>R0736LC25M</b>	2500	2500	736	6800	231 x 10 <sup>3</sup>	70	640	1000	60	1.842	0.619	0.0320	W10	
<b>R0809LC10A</b>	1000	1000	809	8000	320 x 10 <sup>3</sup>	10	120	1000	60	2.100	0.300	0.0320	W10	
<b>R0809LC10B</b>	1000	1000	809	8000	320 x 10 <sup>3</sup>	12	120	1000	60	2.100	0.300	0.0320	W10	
<b>R0830LC12C</b>	1200	1200	830	8500	361 x 10 <sup>3</sup>	15	285	1000	60	1.900	0.357	0.0320	W10	
<b>R0830LC12D</b>	1200	1200	830	8500	361 x 10 <sup>3</sup>	20	285	1000	60	1.900	0.357	0.0320	W10	
<b>R0830LC12E</b>	1200	1200	830	8500	361 x 10 <sup>3</sup>	25	285	1000	60	1.900	0.357	0.0320	W10	
<b>R0830LC12F</b>	1200	1200	830	8500	361 x 10 <sup>3</sup>	30	285	1000	60	1.900	0.357	0.0320	W10	
<b>R0830LC14C</b>	1400	1400	830	8500	361 x 10 <sup>3</sup>	15	285	1000	60	1.900	0.357	0.0320	W10	
<b>R0830LC14D</b>	1400	1400	830	8500	361 x 10 <sup>3</sup>	20	285	1000	60	1.900	0.357	0.0320	W10	
<b>R0830LC14E</b>	1400	1400	830	8500	361 x 10 <sup>3</sup>	25	285	1000	60	1.900	0.357	0.0320	W10	
<b>R0830LC14F</b>	1400	1400	830	8500	361 x 10 <sup>3</sup>	30	285	1000	60	1.900	0.357	0.0320	W10	
<b>R0878LC18K</b>	1800	1800	878	7500	281 x 10 <sup>3</sup>	60	720	1000	60	1.447	0.480	0.0320	W10	
<b>R0878LC18L</b>	1800	1800	878	7500	281 x 10 <sup>3</sup>	65	720	1000	60	1.447	0.480	0.0320	W10	
<b>R0878LC18M</b>	1800	1800	878	7500	281 x 10 <sup>3</sup>	70	720	1000	60	1.447	0.480	0.0320	W10	
<b>R0878LC20K</b>	2000	1800	878	7500	281 x 10 <sup>3</sup>	60	720	1000	60	1.447	0.480	0.0320	W10	
<b>R0878LC20L</b>	2000	1800	878	7500	281 x 10 <sup>3</sup>	65	720	1000	60	1.447	0.480	0.0320	W10	
<b>R0878LC20M</b>	2000	1800	878	7500	281 x 10 <sup>3</sup>	70	720	1000	60	1.447	0.480	0.0320	W10	
<b>R0878LC21K</b>	2100	1800	878	7500	281 x 10 <sup>3</sup>	60	720	1000	60	1.447	0.480	0.0320	W10	
<b>R0878LC21L</b>	2100	1800	878	7500	281 x 10 <sup>3</sup>	65	720	1000	60	1.447	0.480	0.0320	W10	
<b>R0878LC21M</b>	2100	1800	878	7500	281 x 10 <sup>3</sup>	70	720	1000	60	1.447	0.480	0.0320	W10	
<b>R0929LC10A</b>	1000	1000	929	9000	405 x 10 <sup>3</sup>	10	150	1000	60	1.549	0.350	0.0320	W10	
<b>R0929LC10B</b>	1000	1000	929	9000	405 x 10 <sup>3</sup>	12	150	1000	60	1.549	0.350	0.0320	W10	
<b>R0929LC10C</b>	1000	1000	929	9000	405 x 10 <sup>3</sup>	15	150	1000	60	1.549	0.350	0.0320	W10	
<b>R0929LC12A</b>	1200	1200	929	9000	405 x 10 <sup>3</sup>	10	150	1000	60	1.549	0.350	0.0320	W10	
<b>R0929LC12B</b>	1200	1200	929	9000	405 x 10 <sup>3</sup>	12	150	1000	60	1.549	0.350	0.0320	W10	
<b>R0929LC12C</b>	1200	1200	929	9000	405 x 10 <sup>3</sup>	15	150	1000	60	1.549	0.350	0.0320	W10	
<b>R0929LC12D</b>	1200	1200	929	9000	405 x 10 <sup>3</sup>	20	150	1000	60	1.549	0.350	0.0320	W10	
<b>R0929LC12E</b>	1200	1200	929	9000	405 x 10 <sup>3</sup>	25	150	1000	60	1.549	0.350	0.0320	W10	
<b>R0964LC10C</b>	1000	1000	964	9400	442 x 10 <sup>3</sup>	15	170	1000	60	1.530	0.309	0.0320	W10	
<b>R0964LC10D</b>	1000	1000	964	9400	442 x 10 <sup>3</sup>	20	170	1000	60	1.530	0.309	0.0320	W10	
<b>R0964LC10E</b>	1000	1000	964	9400	442 x 10 <sup>3</sup>	25	170	1000	60	1.530	0.309	0.0320	W10	
<b>R0964LC12C</b>	1200	1200	964	9400	442 x 10 <sup>3</sup>	15	170	1000	60	1.530	0.309	0.0320	W10	

# Distributed Gate Thyristors

## Capsule Types

Type Part No.	V <sub>DRM</sub> V	V <sub>RRM</sub> V	I <sub>TAV</sub> T <sub>K</sub> = 55°C A	I <sub>TSM</sub> 10 ms ½ sine V <sub>R</sub> ≤ 60% V <sub>RRM</sub> A	I <sup>2</sup> t A <sup>2</sup> s	t <sub>q</sub> @ 200 V/μs μs	Typ. Reverse Recovery Charge			V <sub>TO</sub> @ T <sub>JM</sub> = 125°C V	r <sub>T</sub> mΩ	R <sub>thJK</sub> 180° Sine K/W	Fig. No.	Package style Outlines on pages O-01...O-29
							Q <sub>rr</sub> μC	@ I <sub>TM</sub> A	@ -di/dt A/μs					
R0964LC12D	1200	1200	964	9400	442 x 10 <sup>3</sup>	20	170	1000	60	1.530	0.309	0.0320	W10	
R0964LC12E	1200	1200	964	9400	442 x 10 <sup>3</sup>	25	170	1000	60	1.530	0.309	0.0320	W10	
R0990LC08A	800	800	990	11000	605 x 10 <sup>3</sup>	10	90	1000	60	1.350	0.350	0.0320	W10	
R0990LC08B	800	800	990	11000	605 x 10 <sup>3</sup>	12	90	1000	60	1.350	0.350	0.0320	W10	
R0990LC08C	800	800	990	11000	605 x 10 <sup>3</sup>	15	90	1000	60	1.350	0.350	0.0320	W10	
R1124NC18J	1800	1800	1124	13500	0.91 x 10 <sup>6</sup>	50	640	1000	60	1.540	0.379	0.0240	W11	
R1124NC18K	1800	1800	1124	13500	0.91 x 10 <sup>6</sup>	60	640	1000	60	1.540	0.379	0.0240	W11	
R1124NC18L	1800	1800	1124	13500	0.91 x 10 <sup>6</sup>	65	640	1000	60	1.540	0.379	0.0240	W11	
R1124NC18M	1800	1800	1124	13500	0.91 x 10 <sup>6</sup>	70	640	1000	60	1.540	0.379	0.0240	W11	
R1124NC20J	2000	1800	1124	13500	0.91 x 10 <sup>6</sup>	50	640	1000	60	1.540	0.379	0.0240	W11	
R1124NC20K	2000	1800	1124	13500	0.91 x 10 <sup>6</sup>	60	640	1000	60	1.540	0.379	0.0240	W11	
R1124NC20L	2000	1800	1124	13500	0.91 x 10 <sup>6</sup>	65	640	1000	60	1.540	0.379	0.0240	W11	
R1124NC20M	2000	1800	1124	13500	0.91 x 10 <sup>6</sup>	70	640	1000	60	1.540	0.379	0.0240	W11	
R1124NC21J	2100	1800	1124	13500	0.91 x 10 <sup>6</sup>	50	640	1000	60	1.540	0.379	0.0240	W11	
R1124NC21K	2100	1800	1124	13500	0.91 x 10 <sup>6</sup>	60	640	1000	60	1.540	0.379	0.0240	W11	
R1124NC21L	2100	1800	1124	13500	0.91 x 10 <sup>6</sup>	65	640	1000	60	1.540	0.379	0.0240	W11	
R1124NC21M	2100	1800	1124	13500	0.91 x 10 <sup>6</sup>	70	640	1000	60	1.540	0.379	0.0240	W11	
R1127NC32P	3200	3200	1127	12800	819 x 10 <sup>3</sup>	120	3500	1000	60	1.500	0.474	0.0220	W11	
R1127NC32R	3200	3200	1127	12800	819 x 10 <sup>3</sup>	140	3500	1000	60	1.500	0.474	0.0220	W11	
R1127NC32S	3200	3200	1127	12800	819 x 10 <sup>3</sup>	160	3500	1000	60	1.500	0.474	0.0220	W11	
R1127NC32T	3200	3200	1127	12800	819 x 10 <sup>3</sup>	200	3500	1000	60	1.500	0.474	0.0220	W11	
R1127NC34R	3400	3400	1127	12800	819 x 10 <sup>3</sup>	140	3500	1000	60	1.500	0.474	0.0220	W11	
R1127NC34S	3400	3400	1127	12800	819 x 10 <sup>3</sup>	160	3500	1000	60	1.500	0.474	0.0220	W11	
R1127NC34T	3400	3400	1127	12800	819 x 10 <sup>3</sup>	200	3500	1000	60	1.500	0.474	0.0220	W11	
R1127NC36R	3600	3600	1127	12800	819 x 10 <sup>3</sup>	140	3500	1000	60	1.500	0.474	0.0220	W11	
R1127NC36S	3600	3600	1127	12800	819 x 10 <sup>3</sup>	160	3500	1000	60	1.500	0.474	0.0220	W11	
R1127NC36T	3600	3600	1127	12800	819 x 10 <sup>3</sup>	200	3500	1000	60	1.500	0.474	0.0220	W11	
R1158NC26N	2600	2600	1158	14500	1.05 x 10 <sup>6</sup>	100	1600	1000	60	1.600	0.400	0.0220	W11	
R1158NC26P	2600	2600	1158	14500	1.05 x 10 <sup>6</sup>	120	1600	1000	60	1.600	0.400	0.0220	W11	
R1158NC26T	2600	2600	1158	14500	1.05 x 10 <sup>6</sup>	200	1600	1000	60	1.600	0.400	0.0220	W11	
R1178NC14E	1400	1400	1178	17000	1.45 x 10 <sup>6</sup>	25	320	1000	60	1.600	0.300	0.0240	W11	
R1178NC14F	1400	1400	1178	17000	1.45 x 10 <sup>6</sup>	30	320	1000	60	1.600	0.300	0.0240	W11	
R1178NC14G	1400	1400	1178	17000	1.45 x 10 <sup>6</sup>	35	320	1000	60	1.600	0.300	0.0240	W11	
R1211NC12C	1200	1200	1211	17600	1.548 x 10 <sup>6</sup>	15	230	1000	60	1.720	0.230	0.0240	W11	
R1211NC12D	1200	1200	1211	17600	1.548 x 10 <sup>6</sup>	20	230	1000	60	1.720	0.230	0.0240	W11	
R1211NC12E	1200	1200	1211	17600	1.548 x 10 <sup>6</sup>	25	230	1000	60	1.720	0.230	0.0240	W11	
R1271NC12B	1200	1200	1271	18000	1.62 x 10 <sup>6</sup>	12	200	1000	60	1.547	0.237	0.0240	W11	
R1271NC12C	1200	1200	1271	18000	1.62 x 10 <sup>6</sup>	15	200	1000	60	1.547	0.237	0.0240	W11	
R1271NC12D	1200	1200	1271	18000	1.62 x 10 <sup>6</sup>	20	200	1000	60	1.547	0.237	0.0240	W11	
R1271NC12E	1200	1200	1271	18000	1.62 x 10 <sup>6</sup>	25	200	1000	60	1.547	0.237	0.0240	W11	
R1275NC18J	1800	1800	1275	15500	1.20 x 10 <sup>6</sup>	50	940	1000	60	1.207	0.342	0.0240	W11	
R1275NC18K	1800	1800	1275	15500	1.20 x 10 <sup>6</sup>	60	940	1000	60	1.207	0.342	0.0240	W11	
R1275NC18L	1800	1800	1275	15500	1.20 x 10 <sup>6</sup>	65	940	1000	60	1.207	0.342	0.0240	W11	
R1275NC18M	1800	1800	1275	15500	1.20 x 10 <sup>6</sup>	70	940	1000	60	1.207	0.342	0.0240	W11	
R1275NC20J	2000	1800	1275	15500	1.20 x 10 <sup>6</sup>	50	940	1000	60	1.207	0.342	0.0240	W11	
R1275NC20K	2000	1800	1275	15500	1.20 x 10 <sup>6</sup>	60	940	1000	60	1.207	0.342	0.0240	W11	
R1275NC20L	2000	1800	1275	15500	1.20 x 10 <sup>6</sup>	65	940	1000	60	1.207	0.342	0.0240	W11	
R1275NC20M	2000	1800	1275	15500	1.20 x 10 <sup>6</sup>	70	940	1000	60	1.207	0.342	0.0240	W11	
R1275NC21J	2100	1800	1275	15500	1.20 x 10 <sup>6</sup>	50	940	1000	60	1.207	0.342	0.0240	W11	
R1275NC21K	2100	1800	1275	15500	1.20 x 10 <sup>6</sup>	60	940	1000	60	1.207	0.342	0.0240	W11	
R1275NC21L	2100	1800	1275	15500	1.20 x 10 <sup>6</sup>	65	940	1000	60	1.207	0.342	0.0240	W11	
R1275NC21M	2100	1800	1275	15500	1.20 x 10 <sup>6</sup>	70	940	1000	60	1.207	0.342	0.0240	W11	
R1279NC22J	2200	2200	1279	14800	1.10 x 10 <sup>6</sup>	50	1250	1000	60	1.440	0.330	0.0220	W11	
R1279NC22K	2200	2200	1279	14800	1.10 x 10 <sup>6</sup>	60	1250	1000	60	1.440	0.330	0.0220	W11	
R1279NC22L	2200	2200	1279	14800	1.10 x 10 <sup>6</sup>	65	1250	1000	60	1.440	0.330	0.0220	W11	
R1279NC22M	2200	2200	1279	14800	1.10 x 10 <sup>6</sup>	70	1250	1000	60	1.440	0.330	0.0220	W11	
R1279NC25J	2500	2500	1279	14800	1.10 x 10 <sup>6</sup>	50	1250	1000	60	1.440	0.330	0.0220	W11	
R1279NC25K	2500	2500	1279	14800	1.10 x 10 <sup>6</sup>	60	1250	1000	60	1.440	0.330	0.0220	W11	



W13 Weight 1700 g



W14 Weight 1300 g

# Distributed Gate Thyristors

## Capsule Types

Type  Part No. ➤ New	V <sub>DRM</sub>  V	V <sub>RRM</sub>  V	I <sub>TAV</sub>  A T <sub>K</sub> = 55°C	I <sub>TSM</sub>  A	I <sup>2</sup> t  10 ms ½ sine V <sub>R</sub> ≤ 60% V <sub>RRM</sub> A <sup>2</sup> s	t <sub>q</sub>  @ 200 V/μs μs	Typ. Reverse Recovery Charge			V <sub>TO</sub>  V	r <sub>T</sub>  mΩ	R <sub>thJK</sub>  180° Sine K/W	Fig. No.	Package style  Outlines on pages O-01...O-29
							Q <sub>rr</sub>  μC	@ I <sub>TM</sub>  A	@ -di/dt  A/μs					
R1279NC25L	2500	2500	1279	14800	1.10 x 10 <sup>6</sup>	65	1250	1000	60	1.440	0.330	0.0220	W11	
R1279NC25M	2500	2500	1279	14800	1.10 x 10 <sup>6</sup>	70	1250	1000	60	1.440	0.330	0.0220	W11	
R1280NC21J	2100	2100	1280	14800	1.10 x 10 <sup>6</sup>	50	1200	1000	60	1.440	0.330	0.0220	W11	
R1280NC21K	2100	2100	1280	14800	1.10 x 10 <sup>6</sup>	60	1200	1000	60	1.440	0.330	0.0220	W11	
R1280NC21L	2100	2100	1280	14800	1.10 x 10 <sup>6</sup>	65	1200	1000	60	1.440	0.330	0.0220	W11	
R1280NC21M	2100	2100	1280	14800	1.10 x 10 <sup>6</sup>	70	1200	1000	60	1.440	0.330	0.0220	W11	
R1280NC22J	2200	2100	1280	14800	1.10 x 10 <sup>6</sup>	50	1200	1000	60	1.440	0.330	0.0220	W11	
R1280NC22K	2200	2100	1280	14800	1.10 x 10 <sup>6</sup>	60	1200	1000	60	1.440	0.330	0.0220	W11	
R1280NC22L	2200	2100	1280	14800	1.10 x 10 <sup>6</sup>	65	1200	1000	60	1.440	0.330	0.0220	W11	
R1280NC22M	2200	2100	1280	14800	1.10 x 10 <sup>6</sup>	70	1200	1000	60	1.440	0.330	0.0220	W11	
R1280NC25J	2500	2100	1280	14800	1.10 x 10 <sup>6</sup>	50	1200	1000	60	1.440	0.330	0.0220	W11	
R1280NC25K	2500	2100	1280	14800	1.10 x 10 <sup>6</sup>	60	1200	1000	60	1.440	0.330	0.0220	W11	
R1280NC25L	2500	2100	1280	14800	1.10 x 10 <sup>6</sup>	65	1200	1000	60	1.440	0.330	0.0220	W11	
R1280NC25M	2500	2100	1280	14800	1.10 x 10 <sup>6</sup>	70	1200	1000	60	1.440	0.330	0.0220	W11	
R1331NC10B	1000	1000	1331	18200	1.66 x 10 <sup>6</sup>	12	200	1000	60	1.450	0.285	0.0220	W11	
R1331NC10C	1000	1000	1331	18200	1.66 x 10 <sup>6</sup>	15	200	1000	60	1.450	0.285	0.0220	W11	
R1331NC10D	1000	1000	1331	18200	1.66 x 10 <sup>6</sup>	20	200	1000	60	1.450	0.285	0.0220	W11	
R1331NC12B	1200	1200	1331	18200	1.66 x 10 <sup>6</sup>	12	200	1000	60	1.450	0.285	0.0220	W11	
R1331NC12C	1200	1200	1331	18200	1.66 x 10 <sup>6</sup>	15	200	1000	60	1.450	0.285	0.0220	W11	
R1331NC12D	1200	1200	1331	18200	1.66 x 10 <sup>6</sup>	20	200	1000	60	1.450	0.285	0.0220	W11	
R1446NC12C	1200	1200	1446	19500	1.90 x 10 <sup>6</sup>	15	300	1000	60	1.304	0.199	0.0240	W11	
R1446NC12E	1200	1200	1446	19500	1.90 x 10 <sup>6</sup>	20	300	1000	60	1.304	0.199	0.0240	W11	
R1446NC12F	1200	1200	1446	19500	1.90 x 10 <sup>6</sup>	30	300	1000	60	1.304	0.199	0.0240	W11	
R1446NC12G	1200	1200	1446	19500	1.90 x 10 <sup>6</sup>	35	300	1000	60	1.304	0.199	0.0240	W11	
R1448NC14H	1400	2000	1448	15500	1.20 x 10 <sup>6</sup>	40	950	1000	60	1.300	0.250	0.0220	W11	
R1448NC14J	1400	2000	1448	15500	1.20 x 10 <sup>6</sup>	50	950	1000	60	1.300	0.250	0.0220	W11	
R1448NC18H	1800	2000	1448	15500	1.20 x 10 <sup>6</sup>	40	950	1000	60	1.300	0.250	0.0220	W11	
R1448NC18J	1800	2000	1448	15500	1.20 x 10 <sup>6</sup>	50	950	1000	60	1.300	0.250	0.0220	W11	
R1448NC20H	2000	2000	1448	15500	1.20 x 10 <sup>6</sup>	40	950	1000	60	1.300	0.250	0.0220	W11	
R1448NC20J	2000	2000	1448	15500	1.20 x 10 <sup>6</sup>	50	950	1000	60	1.300	0.250	0.0220	W11	
R1448NC20K	2000	2000	1448	15500	1.20 x 10 <sup>6</sup>	60	950	1000	60	1.300	0.250	0.0220	W11	
R1448NC20L	2000	2000	1448	15500	1.20 x 10 <sup>6</sup>	65	950	1000	60	1.300	0.250	0.0220	W11	
R1448NC20M	2000	2000	1448	15500	1.20 x 10 <sup>6</sup>	70	950	1000	60	1.300	0.250	0.0220	W11	
R1700MC18E	1800	1800	1700	20000	2.0 x 10 <sup>6</sup>	25	1400	1000	60	1.600	0.250	0.0150	W70	
R1700MC18F	1800	1800	1700	20000	2.0 x 10 <sup>6</sup>	30	1400	1000	60	1.600	0.250	0.0150	W70	
R1700MC18G	1800	1800	1700	20000	2.0 x 10 <sup>6</sup>	35	1400	1000	60	1.600	0.250	0.0150	W70	
R1700MC18H	1800	1800	1700	20000	2.0 x 10 <sup>6</sup>	40	1400	1000	60	1.600	0.250	0.0150	W70	
R1700MC18J	1800	1800	1700	20000	2.0 x 10 <sup>6</sup>	50	1400	1000	60	1.600	0.250	0.0150	W70	
R1700MC21E	2100	1800	1700	20000	2.0 x 10 <sup>6</sup>	25	1400	1000	60	1.600	0.250	0.0150	W70	
R1700MC21F	2100	1800	1700	20000	2.0 x 10 <sup>6</sup>	30	1400	1000	60	1.600	0.250	0.0150	W70	
R1700MC21G	2100	1800	1700	20000	2.0 x 10 <sup>6</sup>	35	1400	1000	60	1.600	0.250	0.0150	W70	
R1700MC21H	2100	1800	1700	20000	2.0 x 10 <sup>6</sup>	40	1400	1000	60	1.600	0.250	0.0150	W70	
R1700MC21J	2100	1800	1700	20000	2.0 x 10 <sup>6</sup>	50	1400	1000	60	1.600	0.250	0.0150	W70	
R2475ZC28M	2800	2800	2475	31000	4.81 x 10 <sup>6</sup>	70	3900	4000	60	1.504	0.174	0.0110	W13	
R2475ZC28N	2800	2800	2475	31000	4.81 x 10 <sup>6</sup>	100	3900	4000	60	1.504	0.174	0.0110	W13	
R2475ZC28R	2800	2800	2475	31000	4.81 x 10 <sup>6</sup>	140	3900	4000	60	1.504	0.174	0.0110	W13	
R2475ZD28M	2800	2800	2475	31000	4.81 x 10 <sup>6</sup>	70	3900	4000	60	1.504	0.174	0.0110	W46	
R2475ZD28N	2800	2800	2475	31000	4.81 x 10 <sup>6</sup>	100	3900	4000	60	1.504	0.174	0.0110	W46	
R2475ZD28R	2800	2800	2475	31000	4.81 x 10 <sup>6</sup>	140	3900	4000	60	1.504	0.174	0.0110	W46	
R2619ZC18J	1800	1800	2619	33800	5.71 x 10 <sup>6</sup>	50	1850	4000	60	1.308	0.173	0.0110	W13	
R2619ZC18K	1800	1800	2619	33800	5.71 x 10 <sup>6</sup>	60	1850	4000	60	1.308	0.173	0.0110	W13	
R2619ZC18L	1800	1800	2619	33800	5.71 x 10 <sup>6</sup>	65	1850	4000	60	1.308	0.173	0.0110	W13	
R2619ZC20J	2000	2000	2619	33800	5.71 x 10 <sup>6</sup>	50	1850	4000	60	1.308	0.173	0.0110	W13	



W15 Weight 2800 g

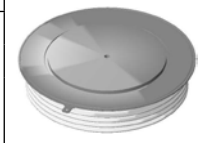

W46 Weight 1200 g



# Distributed Gate Thyristors

## Capsule Types

Type Part No.	V <sub>DRM</sub> V	V <sub>RRM</sub> V	I <sub>TAV</sub> T <sub>K</sub> = 55°C A	I <sub>TSM</sub> 10 ms ½ sine V <sub>R</sub> ≤ 60% V <sub>RRM</sub> A	I <sup>2</sup> t A <sup>2</sup> s	t <sub>q</sub> @ 200 V/μs μs	Typ. Reverse Recovery Charge			V <sub>TO</sub> @ T <sub>JM</sub> = 125°C V	r <sub>T</sub> mΩ	R <sub>thJK</sub> 180° Sine K/W	Fig. No.	Package style Outlines on pages O-01...O-29
							Q <sub>rr</sub> μC	T <sub>JM</sub> @ I <sub>TM</sub> A	@ -di/dt A/μs					
R2619ZC20K	2000	2000	2619	33800	5.71 x 10 <sup>6</sup>	60	1850	4000	60	1.308	0.173	0.0110	W13	
R2619ZC20L	2000	2000	2619	33800	5.71 x 10 <sup>6</sup>	65	1850	4000	60	1.308	0.173	0.0110	W13	
R2619ZC21J	2100	1800	2619	33800	5.71 x 10 <sup>6</sup>	50	1850	4000	60	1.308	0.173	0.0110	W13	
R2619ZC21K	2100	1800	2619	33800	5.71 x 10 <sup>6</sup>	60	1850	4000	60	1.308	0.173	0.0110	W13	
R2619ZC21L	2100	1800	2619	33800	5.71 x 10 <sup>6</sup>	65	1850	4000	60	1.308	0.173	0.0110	W13	
R2619ZC25J	2500	2100	2619	33800	5.71 x 10 <sup>6</sup>	50	1850	4000	60	1.308	0.173	0.0110	W13	
R2619ZC25K	2500	2100	2619	33800	5.71 x 10 <sup>6</sup>	60	1850	4000	60	1.308	0.173	0.0110	W13	
R2619ZC25L	2500	2100	2619	33800	5.71 x 10 <sup>6</sup>	65	1850	4000	60	1.308	0.173	0.0110	W13	
R2619ZD18J	1800	1800	2619	33800	5.71 x 10 <sup>6</sup>	50	1850	4000	60	1.308	0.173	0.0110	W46	
R2619ZD18K	1800	1800	2619	33800	5.71 x 10 <sup>6</sup>	60	1850	4000	60	1.308	0.173	0.0110	W46	
R2619ZD18L	1800	1800	2619	33800	5.71 x 10 <sup>6</sup>	65	1850	4000	60	1.308	0.173	0.0110	W46	
R2619ZD20J	2000	2000	2619	33800	5.71 x 10 <sup>6</sup>	50	1850	4000	60	1.308	0.173	0.0110	W46	
R2619ZD20K	2000	2000	2619	33800	5.71 x 10 <sup>6</sup>	60	1850	4000	60	1.308	0.173	0.0110	W46	
R2619ZD20L	2000	2000	2619	33800	5.71 x 10 <sup>6</sup>	65	1850	4000	60	1.308	0.173	0.0110	W46	
R2619ZD21J	2100	1800	2619	33800	5.71 x 10 <sup>6</sup>	50	1850	4000	60	1.308	0.173	0.0110	W46	
R2619ZD21K	2100	1800	2619	33800	5.71 x 10 <sup>6</sup>	60	1850	4000	60	1.308	0.173	0.0110	W46	
R2619ZD21L	2100	1800	2619	33800	5.71 x 10 <sup>6</sup>	65	1850	4000	60	1.308	0.173	0.0110	W46	
R2619ZD25J	2500	2100	2619	33800	5.71 x 10 <sup>6</sup>	50	1850	4000	60	1.308	0.173	0.0110	W46	
R2619ZD25K	2500	2100	2619	33800	5.71 x 10 <sup>6</sup>	60	1850	4000	60	1.308	0.173	0.0110	W46	
R2619ZD25L	2500	2100	2619	33800	5.71 x 10 <sup>6</sup>	65	1850	4000	60	1.308	0.173	0.0110	W46	
R2620ZC22J	2200	2200	2620	33800	5.71 x 10 <sup>6</sup>	50	2100	4000	60	1.500	0.143	0.0110	W13	
R2620ZC22K	2200	2200	2620	33800	5.71 x 10 <sup>6</sup>	60	2100	4000	60	1.500	0.143	0.0110	W13	
R2620ZC22L	2200	2200	2620	33800	5.71 x 10 <sup>6</sup>	65	2100	4000	60	1.500	0.143	0.0110	W13	
R2620ZC25J	2500	2500	2620	33800	5.71 x 10 <sup>6</sup>	50	2100	4000	60	1.500	0.143	0.0110	W13	
R2620ZC25K	2500	2500	2620	33800	5.71 x 10 <sup>6</sup>	60	2100	4000	60	1.500	0.143	0.0110	W13	
R2620ZC25L	2500	2500	2620	33800	5.71 x 10 <sup>6</sup>	65	2100	4000	60	1.500	0.143	0.0110	W13	
R2620ZD22J	2200	2200	2620	33800	5.71 x 10 <sup>6</sup>	50	2100	4000	60	1.500	0.143	0.0110	W46	
R2620ZD22K	2200	2200	2620	33800	5.71 x 10 <sup>6</sup>	60	2100	4000	60	1.500	0.143	0.0110	W46	
R2620ZD22L	2200	2200	2620	33800	5.71 x 10 <sup>6</sup>	65	2100	4000	60	1.500	0.143	0.0110	W46	
R2620ZD25J	2500	2500	2620	33800	5.71 x 10 <sup>6</sup>	50	2100	4000	60	1.500	0.143	0.0110	W46	
R2620ZD25K	2500	2500	2620	33800	5.71 x 10 <sup>6</sup>	60	2100	4000	60	1.500	0.143	0.0110	W46	
R2620ZD25L	2500	2500	2620	33800	5.71 x 10 <sup>6</sup>	65	2100	4000	60	1.500	0.143	0.0110	W46	
R2714ZC14H	1400	1400	2714	35600	6.34 x 10 <sup>6</sup>	40	1400	4000	60	1.250	0.163	0.0110	W13	
R2714ZC14J	1400	1400	2714	35600	6.34 x 10 <sup>6</sup>	50	1400	4000	60	1.250	0.163	0.0110	W13	
R2714ZC14K	1400	1400	2714	35600	6.34 x 10 <sup>6</sup>	60	1400	4000	60	1.250	0.163	0.0110	W13	
R2714ZC18H	1800	1800	2714	35600	6.34 x 10 <sup>6</sup>	40	1400	4000	60	1.250	0.163	0.0110	W13	
R2714ZC18J	1800	1800	2714	35600	6.34 x 10 <sup>6</sup>	50	1400	4000	60	1.250	0.163	0.0110	W13	
R2714ZC18K	1800	1800	2714	35600	6.34 x 10 <sup>6</sup>	60	1400	4000	60	1.250	0.163	0.0110	W13	
R2714ZD14H	1400	1400	2714	35600	6.34 x 10 <sup>6</sup>	40	1400	4000	60	1.250	0.163	0.0110	W46	
R2714ZD14J	1400	1400	2714	35600	6.34 x 10 <sup>6</sup>	50	1400	4000	60	1.250	0.163	0.0110	W46	
R2714ZD14K	1400	1400	2714	35600	6.34 x 10 <sup>6</sup>	60	1400	4000	60	1.250	0.163	0.0110	W46	
R2714ZD18H	1800	1800	2714	35600	6.34 x 10 <sup>6</sup>	40	1400	4000	60	1.250	0.163	0.0110	W46	
R2714ZD18J	1800	1800	2714	35600	6.34 x 10 <sup>6</sup>	50	1400	4000	60	1.250	0.163	0.0110	W46	
R2714ZD18K	1800	1800	2714	35600	6.34 x 10 <sup>6</sup>	60	1400	4000	60	1.250	0.163	0.0110	W46	
R3047TC24K	2400	2400	3047	50000	12.5 x 10 <sup>6</sup>	60	2100	4000	60	1.580	0.170	0.0080	W14	
R3047TC24L	2400	2400	3047	50000	12.5 x 10 <sup>6</sup>	65	2100	4000	60	1.580	0.170	0.0080	W14	
R3047TC24M	2400	2400	3047	50000	12.5 x 10 <sup>6</sup>	70	2100	4000	60	1.580	0.170	0.0080	W14	
R3047TC24N	2400	2400	3047	50000	12.5 x 10 <sup>6</sup>	100	2100	4000	60	1.580	0.170	0.0080	W14	
R3047TC28K	2800	2800	3047	50000	12.5 x 10 <sup>6</sup>	60	2100	4000	60	1.580	0.170	0.0080	W14	
R3047TC28L	2800	2800	3047	50000	12.5 x 10 <sup>6</sup>	65	2100	4000	60	1.580	0.170	0.0080	W14	
R3047TC28M	2800	2800	3047	50000	12.5 x 10 <sup>6</sup>	70	2100	4000	60	1.580	0.170	0.0080	W14	
R3047TC28N	2800	2800	3047	50000	12.5 x 10 <sup>6</sup>	100	2100	4000	60	1.580	0.170	0.0080	W14	





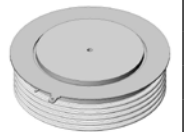













W48 Weight 2000 g



W51 Weight 1700 g

# Distributed Gate Thyristors

## Capsule Types

Type  Part No. ➤ New	V <sub>DRM</sub>  V	V <sub>RRM</sub>  V	I <sub>TAV</sub>  A T <sub>K</sub> = 55°C	I <sub>TSM</sub>  A	I <sup>2</sup> t  10 ms ½ sine V <sub>R</sub> ≤ 60% V <sub>RRM</sub> A <sup>2</sup> s	t <sub>q</sub>  @ 200 V/μs μs	Typ. Reverse Recovery Charge			V <sub>T0</sub>  V	r <sub>T</sub>  @ T <sub>JM</sub> mΩ	R <sub>thJK</sub>  180° Sine K/W	Fig. No.	Package style  Outlines on pages O-01...O-29
							Q <sub>rr</sub>  μC	@ I <sub>TM</sub>  A	@ -di/dt  A/μs					
R3047TD24K	2400	2400	3047	50000	12.5 x 10 <sup>6</sup>	60	2100	4000	60	1.580	0.170	0.0080	W51	
R3047TD24L	2400	2400	3047	50000	12.5 x 10 <sup>6</sup>	65	2100	4000	60	1.580	0.170	0.0080	W51	
R3047TD24M	2400	2400	3047	50000	12.5 x 10 <sup>6</sup>	70	2100	4000	60	1.580	0.170	0.0080	W51	
R3047TD24N	2400	2400	3047	50000	12.5 x 10 <sup>6</sup>	100	2100	4000	60	1.580	0.170	0.0080	W51	
R3047TD28K	2800	2800	3047	50000	12.5 x 10 <sup>6</sup>	60	2100	4000	60	1.580	0.170	0.0080	W51	
R3047TD28L	2800	2800	3047	50000	12.5 x 10 <sup>6</sup>	65	2100	4000	60	1.580	0.170	0.0080	W51	
R3047TD28M	2800	2800	3047	50000	12.5 x 10 <sup>6</sup>	70	2100	4000	60	1.580	0.170	0.0080	W51	
R3047TD28N	2800	2800	3047	50000	12.5 x 10 <sup>6</sup>	100	2100	4000	60	1.580	0.170	0.0080	W51	
R3370ZC12C	1200	1200	3370	43900	9.64 x 10 <sup>6</sup>	15	600	4000	60	1.353	0.064	0.0110	W13	
R3370ZC12D	1200	1200	3370	43900	9.64 x 10 <sup>6</sup>	20	600	4000	60	1.353	0.064	0.0110	W13	
R3370ZC12E	1200	1200	3370	43900	9.64 x 10 <sup>6</sup>	25	600	4000	60	1.353	0.064	0.0110	W13	
R3370ZD12C	1200	1200	3370	43900	9.64 x 10 <sup>6</sup>	15	600	4000	60	1.353	0.064	0.0110	W46	
R3370ZD12D	1200	1200	3370	43900	9.64 x 10 <sup>6</sup>	20	600	4000	60	1.353	0.064	0.0110	W46	
R3370ZD12E	1200	1200	3370	43900	9.64 x 10 <sup>6</sup>	25	600	4000	60	1.353	0.064	0.0110	W46	
R3559TC16K	1600	1600	3559	38900	7.57 x 10 <sup>6</sup>	60	1750	4000	60	1.173	0.155	0.0080	W14	
R3559TC16M	1600	1600	3559	38900	7.57 x 10 <sup>6</sup>	70	1750	4000	60	1.173	0.155	0.0080	W14	
R3559TC16N	1600	1600	3559	38900	7.57 x 10 <sup>6</sup>	100	1750	4000	60	1.173	0.155	0.0080	W14	
R3559TC20K	2000	2000	3559	38900	7.57 x 10 <sup>6</sup>	60	1750	4000	60	1.173	0.155	0.0080	W14	
R3559TC20M	2000	2000	3559	38900	7.57 x 10 <sup>6</sup>	70	1750	4000	60	1.173	0.155	0.0080	W14	
R3559TC20N	2000	2000	3559	38900	7.57 x 10 <sup>6</sup>	100	1750	4000	60	1.173	0.155	0.0080	W14	
R3559TD16K	1600	1600	3559	38900	7.57 x 10 <sup>6</sup>	60	1750	4000	60	1.173	0.155	0.0080	W51	
R3559TD16M	1600	1600	3559	38900	7.57 x 10 <sup>6</sup>	70	1750	4000	60	1.173	0.155	0.0080	W51	
R3559TD16N	1600	1600	3559	38900	7.57 x 10 <sup>6</sup>	100	1750	4000	60	1.173	0.155	0.0080	W51	
R3559TD20K	2000	2000	3559	38900	7.57 x 10 <sup>6</sup>	60	1750	4000	60	1.173	0.155	0.0080	W51	
R3559TD20M	2000	2000	3559	38900	7.57 x 10 <sup>6</sup>	70	1750	4000	60	1.173	0.155	0.0080	W51	
R3559TD20N	2000	2000	3559	38900	7.57 x 10 <sup>6</sup>	100	1750	4000	60	1.173	0.155	0.0080	W51	
R3636EC16K	1600	1600	3636	38900	7.57 x 10 <sup>6</sup>	60	1750	4000	60	1.173	0.155	0.0075	W55	
R3636EC16M	1600	1600	3636	38900	7.57 x 10 <sup>6</sup>	70	1750	4000	60	1.173	0.155	0.0075	W55	
R3636EC16N	1600	1600	3636	38900	7.57 x 10 <sup>6</sup>	100	1750	4000	60	1.173	0.155	0.0075	W55	
R3636EC20K	2000	2000	3636	38900	7.57 x 10 <sup>6</sup>	60	1750	4000	60	1.173	0.155	0.0075	W55	
R3636EC20M	2000	2000	3636	38900	7.57 x 10 <sup>6</sup>	70	1750	4000	60	1.173	0.155	0.0075	W55	
R3636EC20N	2000	2000	3636	38900	7.57 x 10 <sup>6</sup>	100	1750	4000	60	1.173	0.155	0.0075	W55	
R3708FC45V	4500	3000	3708	50000	12.5 x 10 <sup>6</sup>	250	8800	4000	60	1.473	0.156	0.0065	W15	
R3708FC45W	4500	3000	3708	50000	12.5 x 10 <sup>6</sup>	300	8800	4000	60	1.473	0.156	0.0065	W15	
R3708FD45V	4500	3000	3708	50000	12.5 x 10 <sup>6</sup>	250	8800	4000	60	1.473	0.156	0.0065	W48	
R3708FD45W	4500	3000	3708	50000	12.5 x 10 <sup>6</sup>	300	8800	4000	60	1.473	0.156	0.0065	W48	
R3968FC24K	2400	2400	4001	66000	21.78 x 10 <sup>6</sup>	60	2600	4000	60	1.453	0.125	0.0065	W15	
R3968FC24M	2400	2400	4001	66000	21.78 x 10 <sup>6</sup>	70	2600	4000	60	1.453	0.125	0.0065	W15	
R3968FC24N	2400	2400	4001	66000	21.78 x 10 <sup>6</sup>	100	2600	4000	60	1.453	0.125	0.0065	W15	
R3968FC28K	2800	2800	4001	66000	21.78 x 10 <sup>6</sup>	60	2600	4000	60	1.453	0.125	0.0065	W15	
R3968FC28M	2800	2800	4001	66000	21.78 x 10 <sup>6</sup>	70	2600	4000	60	1.453	0.125	0.0065	W15	
R3968FC28N	2800	2800	4001	66000	21.78 x 10 <sup>6</sup>	100	2600	4000	60	1.453	0.125	0.0065	W15	
R3968FD24K	2400	2400	4001	66000	21.78 x 10 <sup>6</sup>	60	2600	4000	60	1.453	0.125	0.0065	W48	
R3968FD24M	2400	2400	4001	66000	21.78 x 10 <sup>6</sup>	70	2600	4000	60	1.453	0.125	0.0065	W48	
R3968FD24N	2400	2400	4001	66000	21.78 x 10 <sup>6</sup>	100	2600	4000	60	1.453	0.125	0.0065	W48	
R3968FD28K	2800	2800	4001	66000	21.78 x 10 <sup>6</sup>	60	2600	4000	60	1.453	0.125	0.0065	W48	
R3968FD28M	2800	2800	4001	66000	21.78 x 10 <sup>6</sup>	70	2600	4000	60	1.453	0.125	0.0065	W48	
R3968FD28N	2800	2800	4001	66000	21.78 x 10 <sup>6</sup>	100	2600	4000	60	1.453	0.125	0.0065	W48	

T<sub>JM</sub> = 125°C

# Distributed Gate Thyristors

## Asymmetric Thyristors

These devices are available up to a voltage of 2800V. They exhibit very fast turn-on times and are capable of very high values of both critical di/dt and dv/dt. For the device type, they also exhibit high current ratings in excess of 1000A.

Type	$V_{DRM}$	$I_{TAV}$	$I_{TSM}$	$I^2t$	$t_{gd}$	typ. $t_q$	$(di/dt)_{cr}$	$(dv/dt)_{cr}$	$V_{TO}$	$r_T$	$T_{JM}$	$R_{thJK}$	Fig. No.	Package style
Part No.	$V_{RRM}$	$T_K = 55^\circ C$	10 ms $\frac{1}{2}$ sine $V_R \leq 60\% V_{RRM}$	$\frac{1}{2}$ sine	25°C	@	@	@ $T_{JM}$	@ $T_{JM}$	@ $T_{JM}$	180° Sine	Outlines on pages O-01...O-29		
	V	A	A	A <sup>2</sup> s	$\mu s$	200 V/ $\mu s$	A	A/ $\mu s$	V	m $\Omega$	°C	K/W		
<b>A0516YC240</b>	2400	516	5700	$1.51 \times 10^3$	0.5	55	2000	3000	1.630	0.850	125	0.050	W58	
<b>A0516YC280</b>	2800	516	5700	$1.51 \times 10^3$	0.5	55	2000	3000	1.630	0.850	125	0.050	W58	
<b>A1237NC240</b>	2400	1237	18000	$1.62 \times 10^6$	0.9	30	2000	3000	1.707	0.212	125	0.024	W11	
<b>A1237NC280</b>	2800	1237	18000	$1.62 \times 10^6$	0.9	30	2000	3000	1.707	0.212	125	0.024	W11	



W11 Weight 510 g

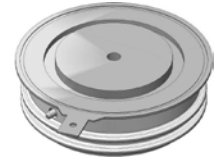

W58 Weight 90 g

## Pulse Thyristors

IXYS UK Westcode Ltd are at the forefront of solid state pulsed power technology, offering custom solutions to complex pulsed power problems.

Standard Devices with voltage ratings to 2.5kV, pulsed currents to 150kA peak and di/dt capabilities to over 30kA/ $\mu s$  are available. Please consult factory for other requirements

Type	$V_{DRM}$	$V_{RRM}$	$V_{DC}$	$I_{PULSE}$	$(di/dt)_{cr}$	$V_{TO}$	$r_T$	$T_{JM}$	$R_{thJC}$	Fig. No.	Package style
Part No.	$V_{GK} = 2 V$		$V_{GK} = 2 V$		@ $T_{JM}$	@ $T_{JM}$	@ $T_{JM}$	180° Sine	Outlines on pages O-01...O-29		
	V	V	V	kA	kA/ $\mu s$	V	m $\Omega$	°C	K/W		
<b>Y200CKC250</b>	2500	2000	1500	20	5	1.216	2.196	125	0.065	W34	
<b>Y500CNC250</b>	2500	2000	1500	50	11	1.755	1.122	125	0.027	W36	



W34 Weight 120 g



W36 Weight 500 g

# Gate Turn Off Thyristors

IXYS UK offers a broad range of high specification devices with voltage ratings to 4.5kV (2.8kV DC link) and controllable current ratings of up to 4kA are available to meet the toughest demands in applications such as traction propulsion and auxiliaries, AC industrial drives, FACT's and active VAr controllers. Offering both symmetrical devices for applications with a reverse blocking requirement e.g. current sourced inverters and asymmetric blocking devices for applications where no reverse blocking requirement exists e.g. voltage sourced inverters.

Gate Turn-off Thyristors are still the component of choice when it comes to very high power converters and we remain totally committed to this technology for the foreseeable future.

Type Part No. New	$V_{DRM}$ $V_{GK} = -2V$ V	$V_{RRM}$ V	$I_{TGQM} @ C_s$		$I_{TAV}$ $T_K = 55^\circ C$ A	$I_{TSM}$ kA	$I^2t$ 10 ms 1/2 sine $V_R \leq 10 V$ kA <sup>2</sup> s	Typ. Switching Times		$V_T$ $I_T = I_{TGQM}$ V	$T_{JM}$ °C	$R_{thJK}$ 180° Sine K/W	Fig. No.
			A	µC				$t_{gt}$ µs	$t_{gq}$ µs				
G1000NC450	4500	18	1000	2.0	545	8.00	320 x 10 <sup>3</sup>	4.5	14	4.0	125	0.0270	W36
G1000QC250	2500	18	1000	1.0	615	8.00	320 x 10 <sup>3</sup>	2.8	13	2.5	125	0.0380	W35
G1000QC450	4500	18	1000	1.0	615	8.00	320 x 10 <sup>3</sup>	2.8	13	2.5	125	0.0380	W35
G2000HF250	2500	18	2000	4.0	1030	16.00	1.28 x 10 <sup>6</sup>	3.0	25	2.8	125	0.0220	W85
G2000HF450	4500	18	2000	4.0	890	13.70	938 x 10 <sup>3</sup>	4.0	25	3.5	125	0.0220	W85
G2500HF250	2500	18	2500	6.0	1085	16.00	1.28 x 10 <sup>6</sup>	3.0	25	3.1	125	0.0220	W85
G3000TF250	2500	18	3000	5.0	1640	30.00	4.5 x 10 <sup>6</sup>	3.0	25	2.5	125	0.0150	W86
G3000TF450	4500	18	3000	6.0	1180	24.00	2.88 x 10 <sup>6</sup>	9.0	28	4.0	125	0.0150	W86
G4000EC450	4500	18	4000	6.0	1270	25.00	3.13 x 10 <sup>6</sup>	7.5	28	4.4	125	0.0150	W33
H0500KC200	2000	2000	500	1.0	280	3.00	45 x 10 <sup>3</sup>	2.0	5	3.2	125	0.0650	W34
H0500KC20Y	2000	100	500	1.0	280	3.00	45 x 10 <sup>3</sup>	2.0	5	3.2	125	0.0650	W34
H0500KC25D	2500	2000	500	1.0	280	3.00	45 x 10 <sup>3</sup>	2.0	5	3.2	125	0.0650	W34
H0500KC25Y	2500	100	500	1.0	280	3.00	45 x 10 <sup>3</sup>	2.0	5	3.2	125	0.0650	W34
H0700KC140	1400	1400	700	1.5	360	4.00	80 x 10 <sup>3</sup>	3.0	5	2.75	125	0.0630	W34
H0700KC14Y	1400	100	700	1.5	360	4.00	80 x 10 <sup>3</sup>	3.0	5	2.75	125	0.0630	W34
H0700KC17D	1700	1400	700	1.5	360	4.00	80 x 10 <sup>3</sup>	3.0	5	2.75	125	0.0630	W34
H0700KC17Y	1700	100	700	1.5	360	4.00	80 x 10 <sup>3</sup>	3.0	5	2.75	125	0.0630	W34
H1200NC200	2000	2000	1200	3.0	670	10.50	550 x 10 <sup>3</sup>	3.0	12	3.3	125	0.0270	W36
H1200NC20Y	2000	100	1200	3.0	670	10.50	550 x 10 <sup>3</sup>	3.0	12	3.3	125	0.0270	W36
H1200NC25D	2500	2000	1200	3.0	670	10.50	550 x 10 <sup>3</sup>	3.0	12	3.3	125	0.0270	W36
H1200NC25Y	2500	100	1200	3.0	670	10.50	550 x 10 <sup>3</sup>	3.0	12	3.3	125	0.0270	W36
S0300SR12D	1200	960	480	1.0	215	3.50	61.2 x 10 <sup>3</sup>	3.5	9	2.4	125	0.1300	W87
S0300SR12Y	1200	100	480	1.0	215	3.50	61.2 x 10 <sup>3</sup>	3.5	9	2.4	125	0.1300	W87
S0500YC20Y	2000	100	500	1.0	275	4.00	80 x 10 <sup>3</sup>	3.5	10	2.5	125	0.0870	W93
S0500YC25Y	2500	100	500	1.0	275	4.00	80 x 10 <sup>3</sup>	3.5	10	2.5	125	0.0870	W93
S0500KC200	2000	2000	500	1.0	330	4.00	80 x 10 <sup>3</sup>	3.5	10	2.5	125	0.0650	W34
S0500KC20Y	2000	100	500	1.0	330	4.00	80 x 10 <sup>3</sup>	3.5	10	2.5	125	0.0650	W34
S0500KC25D	2500	2000	500	1.0	330	4.00	80 x 10 <sup>3</sup>	3.5	10	2.5	125	0.0650	W34
S0500KC25Y	2500	100	500	1.0	330	4.00	80 x 10 <sup>3</sup>	3.5	10	2.5	125	0.0650	W34
S0700KC140	1400	1400	700	1.5	430	5.00	125 x 10 <sup>3</sup>	3.0	10	2.2	125	0.0630	W34
S0700KC14Y	1400	100	700	1.5	430	5.00	125 x 10 <sup>3</sup>	3.0	10	2.2	125	0.0630	W34
S0700KC17D	1700	1400	700	1.5	430	5.00	125 x 10 <sup>3</sup>	3.0	10	2.2	125	0.0630	W34
S0700KC17Y	1700	100	700	1.5	430	5.00	125 x 10 <sup>3</sup>	3.0	10	2.2	125	0.0630	W34
S1000NC300	3000	3000	1000	2.0	600	10.00	500 x 10 <sup>3</sup>	5.0	19	3.5	125	0.0270	W36
S1000NC30Y	3000	100	1000	2.0	600	10.00	500 x 10 <sup>3</sup>	5.0	19	3.5	125	0.0270	W36
S1000NC36D	3600	2880	1000	2.0	600	10.00	500 x 10 <sup>3</sup>	5.0	19	3.5	125	0.0270	W36
S1000NC36Y	3600	100	1000	2.0	600	10.00	500 x 10 <sup>3</sup>	5.0	19	3.5	125	0.0270	W36
S1200NC200	2000	2000	1200	3.0	790	13.00	840 x 10 <sup>3</sup>	4.5	19	2.7	125	0.0270	W36
S1200NC20Y	2000	100	1200	3.0	790	13.00	840 x 10 <sup>3</sup>	4.5	19	2.7	125	0.0270	W36
S1200NC25D	2500	2000	1200	3.0	790	13.00	840 x 10 <sup>3</sup>	4.5	19	2.7	125	0.0270	W36
S1200NC25Y	2500	100	1200	3.0	790	13.00	840 x 10 <sup>3</sup>	4.5	19	2.7	125	0.0270	W36

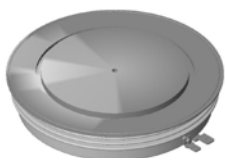

W33 Weight 1500 g



W34 Weight 120 g



W35 Weight 300 g



W36 Weight 500 g

Outlines on pages  
O-01...O-29

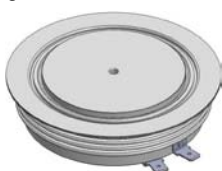

W85 Weight 990 g

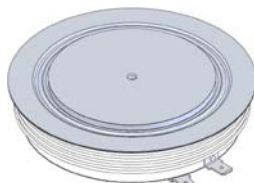

W86 Weight 1240 g



W93 Weight 90 g

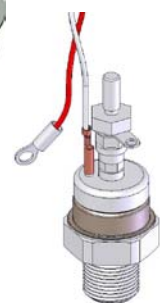

W87 Weight 250 g

# Insulated Gate Bi-polar Transistors

## Capsule Types

As a pioneer of Press-Pack IGBT technology, we are able to offer a range of class leading devices with voltage ratings of 2.5kV (1.25kV DC link) and 4.5kV (2.8kV DC link). The construction of these devices is totally free from wire and solder bonds which all but eliminates the problems of mechanical fatigue associated with conventional modules. Internal stray inductance in both the gate connections and emitter connections is vastly reduced when compared to conventional modules leading to improved ruggedness and short circuit behavior, which is further enhanced by direct cooling of the emitter side of the chip.

These devices are based on a state of the art soft punch through (SPT++) process, which yields exceptional values of  $V_{CE(sat)}$  and quiet switching behavior despite the high voltage ratings, yet the devices feature a positive temperature coefficient making them suitable for reliable parallel operation. Devices available with or without integral anti-parallel diode; a range of complimentary extra fast recovery diodes optimized for use with these IGBTs are available now with a new generation using improved technology in development. Please contact your representative for more information.

The press-pack IGBT's exhibit exceptional power cycling performance; typically an order of magnitude better than modules, making them highly suited to applications such as induction power supplies, melting/heating and mass transit systems where there are repeated cyclic power demands. Press-pack IGBT's have rupture rated housings making them a good choice in critical applications such as mining, the petro-chemical industry, and transportation applications. Press-pack IGBT's have a stable short circuit failure mode which, as well as safety benefits, makes them an ideal choice for medium and high voltage applications where series connection is required. Press-pack construction is the obvious choice where series connection is needed and the short circuit failure mode allows for the design in of n+redundancy. Typical examples include HVDC, Active VAR controllers and medium voltage drives.

These PPIGBT's are largely backwardly compatible with standard 2.5kV and 4.5kV GTOs in many applications such as AC drives. This makes these parts a simple and economical path to upgrade or refurbish equipment that previously used GTOs, such as locomotives or medium voltage drives. They are suitable for all cooling options including direct liquid immersion. Complementary gate drives, mounting clamps and passive components available.

Type Part No.	$V_{CES}$ V	$I_C$ A	$I_{CM}$ A	$V_{CE(sat)}$ @ $I_C$ V	IGBT Switching typical		$V_F$ @ $I_C$ V	Diode Recovery typical			$T_{JM}$ °C	$R_{thJK}$		Fig. No.
					$E_{ON}$ J	$E_{OFF}$ J		$I_{rm}$ A	$t_{rr}$ µs	$Q_r$ µC		IGBT K/W	Diode K/W	
T0360NB25A	2500	360	720	2.95	0.85	0.60	2.25	240	0.9	320	125	0.0541	0.0730	W40
T0500NB25E	2500	500	1000	2.90	1.20	0.84	N/A	N/A	N/A	N/A	125	0.0386	N/A	W40
T0570VB25G	2500	570	1140	2.95	1.40	0.95	2.05	320	1.6	450	125	0.0338	0.0365	W67
T0850VB25E	2500	850	1700	2.90	2.00	1.40	N/A	N/A	N/A	N/A	125	0.0225	N/A	W67
T1200TB25A	2500	1200	2400	3.00	2.80	2.00	2.50	660	1.1	950	125	0.0169	0.0292	W41
T1500TB25E	2500	1500	3000	2.90	3.70	2.60	N/A	N/A	N/A	N/A	125	0.0129	N/A	W41
T2250AB25E	2500	2250	4500	2.90	5.30	3.70	N/A	N/A	N/A	N/A	125	0.0085	N/A	W71
T0160NB45A	4500	160	320	3.40	1.10	0.70	3.75	120	2.7	300	125	0.0720	0.1720	W40
T0240NB45E	4500	240	480	3.80	1.50	1.10	N/A	N/A	N/A	N/A	125	0.0525	N/A	W40
T0340VB45G	4500	340	680	3.50	2.90	1.40	3.45	220	3.2	500	125	0.0364	0.0576	W67
T0510VB45E	4500	510	1020	3.60	4.20	2.10	N/A	N/A	N/A	N/A	125	0.0243	N/A	W67
T0600TB45A	4500	600	1200	3.70	4.60	2.90	3.90	640	1.2	700	125	0.0218	0.0432	W41
T0800TB45E	4500	800	1600	3.50	7.00	4.30	N/A	N/A	N/A	N/A	125	0.0156	N/A	W41
T0800EB45G	4500	800	1600	3.60	6.30	3.70	3.50	800	1.5	1020	125	0.0156	0.0247	W44
T0900EB45A	4500	900	1800	3.80	3.80	3.60	3.90	610	2.3	920	125	0.0140	0.0260	W44
T1200EB45E	4500	1200	2400	3.60	5.70	5.10	N/A	N/A	N/A	N/A	125	0.0080	N/A	W44
T1600GB45G	4500	1600	3200	3.50	14.00	8.70	3.45	1380	1.7	1970	125	0.0078	0.0123	W45
T1800GB45A	4500	1800	3600	3.60	12.60	9.50	3.90	1600	1.6	1850	125	0.0073	0.0144	W45
T2400GB45E	4500	2400	4800	3.60	15.00	14.00	N/A	N/A	N/A	N/A	125	0.0052	N/A	W45



W40 Weight 430 g

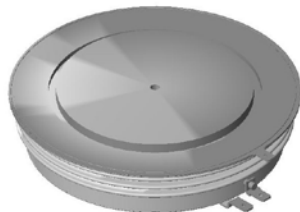

W41 Weight 1200 g



W44 Weight 1200 g

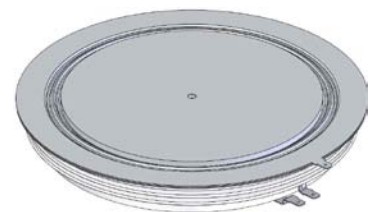

W45 Weight 2000 g

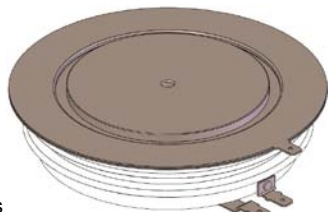

W67 Weight 650 g



W71 Weight 1500 g

Outlines on pages  
O-01...O-29

# Press-Pack IGBT Gate Drive Units

The C0044BG400 IGBT Gate Driver is a low power consumption driver with on board  $V_{CE}$  desaturation detection for high reliability application. The driver features a fibre-optic communication interface for drive, status and switching feedback signals. A fully supervised DC/DC converter with EMI filtering, low coupling capacitance and high partial discharge level is integrated into the board. The high voltage collector sense and gate interface are implemented on a separate card to allow close coupling to the IGBT. A range of pre-configured boards is available to complement IXYS UK's range of press-pack IGBTs – other applications on request.

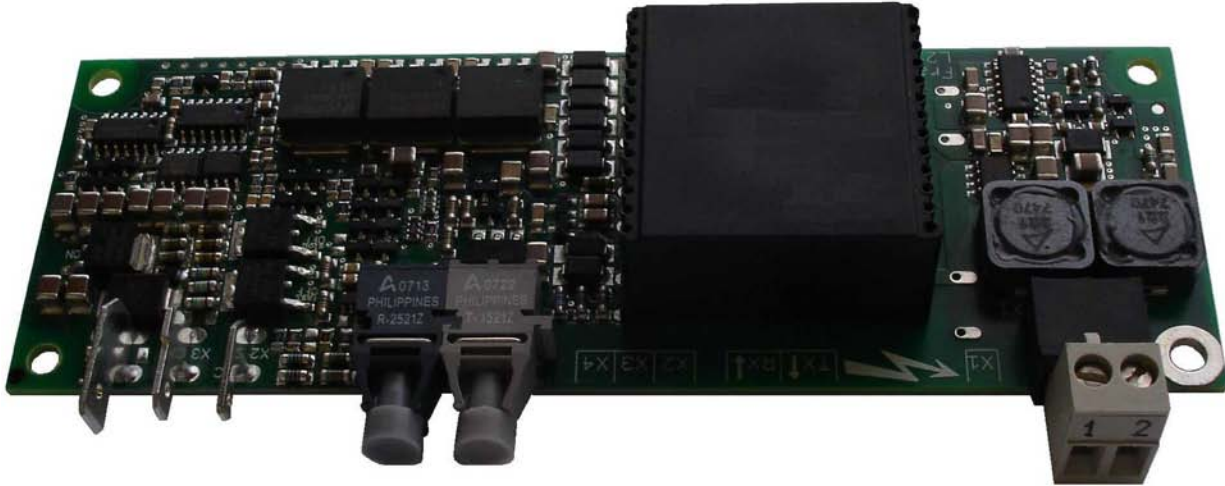

A range of pre-configured boards is available to complement IXYS UK's range of press-pack IGBTs see table below, other applications on request.

Gate Drive Part Number	IGBT Type
C0044BG400SBK	T0160NB45A
C0044BG400SBL	T0240NB45E
C0044BG400SBQ	T0340VB45G
C0044BG400SBA	T0360NB25A
C0044BG400SBB	T0500NB25E
C0044BG400SBE	T0510VB45E
C0044BG400SBF	T0570VB25G
C0044BG400SBM	T0600TB45A
C0044BG400SBG	T0800EB45G
C0044BG400SBN	T0800TB45E
C0044BG400SBH	T0850VB25E
C0044BG400SBP	T0900EB45A
C0044BG400SBR	T1200EB45E
C0044BG400SBC	T1200TB25A
C0044BG400SBD	T1500TB25E
C0044BG400SBJ	T1600GB45G
C0044BG400SBS	T1800GB45A
C0044BG400SBV	T2250AB25E
C0044BG400SBT	T2400GB45E

## FEATURES

- High reliability topology
- Designed for ultra low power consumption
- Build in DC/DC-converter with soft start
- Integrated input filter for low EMI
- Separate low impedance path for parasitic EMI currents
- PD-Voltage levels available up to 11 kV on request.
- Low impedance from gate to emitter at start-up and power fail
- Monitoring of all secondary supply voltages
- Monitoring of IGBT switching status ( $V_{CE}$ -de-sat detection)
- Soft switch-OFF at  $V_{CE}$ -de-sat fault condition
- Fiber-optic links for switching commands and status control
- Low light protection for input signal
- Short-pulse suppression, configurable
- Balanced propagation delay time
- Gate Current up to 44 A
- Optional gate-speed-up capacitors

## APPLICATION

- Large and medium drives
- Renewable generation.
- Utilities scale converters

# Dual Thyristor Modules

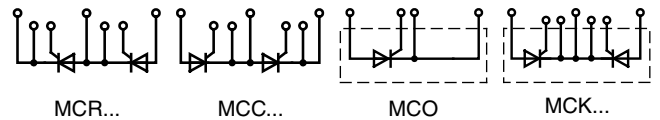

IXYS UK Westcode Ltd. has UL Certification for most modules (Underwriters Laboratories Inc). See the UL Listing.

Part No.	$V_{RRM}$	$I_{TAV}$	@ $T_C$	$I_{TRMS}$	$I_{TSM}$	$V_{TO}$	$r_T$	$T_{VJM}$	$R_{thJC}$	$R_{thCH}$	Fig. No.
	$V_{DRM}$										
○ Not for new design					125°C 10 ms						
➤ New	V	A	°C	A	A	V	mΩ	°C	K/W	K/W	
MCC320-30io2	3000	327	85	765	5000	1.150	0.800	125	0.0650	0.2000	W74
MCC320-36io2	3600	327	85	765	5000	1.150	0.800	125	0.0650	0.2000	W74
MCC431-20io2	2000	429	85	1020	10900	1.000	0.410	125	0.0620	0.0200	W74
MCC431-22io2	2200	429	85	1020	10900	1.000	0.410	125	0.0620	0.0200	W74
MCC431-24io2	2400	429	85	1020	10900	1.000	0.410	125	0.0620	0.0200	W74
○ MCC500-14io1	1400	500	89	1294	16500	0.850	0.270	125	0.0620	0.0200	W63
○ MCC500-18io1	1800	500	89	1294	16500	0.850	0.270	125	0.0620	0.0200	W63
○ MCC500-22io1	2200	500	80	1071	14000	0.880	0.460	125	0.0620	0.0200	W63
○ MCK500-14io1	1400	500	89	1294	16500	0.850	0.270	125	0.0620	0.0200	W63
○ MCK500-18io1	1800	500	89	1294	16500	0.850	0.270	125	0.0620	0.0200	W63
○ MCK500-22io1	2200	500	80	1071	14000	0.880	0.460	125	0.0620	0.0200	W63
MCC501-12io2	1200	503	85	1195	14500	0.850	0.300	125	0.0620	0.0200	W74
MCC501-14io2	1400	503	85	1195	14500	0.850	0.300	125	0.0620	0.0200	W74
MCC501-16io2	1600	503	85	1195	14500	0.850	0.300	125	0.0620	0.0200	W74
MCC501-18io2	1800	503	85	1195	14500	0.850	0.300	125	0.0620	0.0200	W74
➤ MCC552-12io2	1200	550	85	1300	15800	0.770	0.259	125	0.0620	0.0200	W74
➤ MCC552-14io2	1400	550	85	1300	15800	0.770	0.259	125	0.0620	0.0200	W74
➤ MCC552-16io2	1600	550	85	1300	15800	0.770	0.259	125	0.0620	0.0200	W74
➤ MCC500-30io7	3000	500	85	1181	18000	1.079	0.422	125	0.0500	0.0160	W88
➤ MCC500-36io7	3600	500	85	1181	18000	1.079	0.422	125	0.0500	0.0160	W88
➤ MCR500-30io7	3000	500	85	1181	18000	1.079	0.422	125	0.0500	0.0160	W88
➤ MCR500-36io7	3600	500	85	1181	18000	1.079	0.422	125	0.0500	0.0160	W88
➤ MCC580-28io7	2800	581	85	1372	21000	0.926	0.313	125	0.0500	0.0160	W88
➤ MCR580-28io7	2800	581	85	1372	21000	0.926	0.313	125	0.0500	0.0160	W88
➤ MCC650-24io7	2400	646	85	1542	24500	0.874	0.227	125	0.0500	0.0160	W88
➤ MCR650-24io7	2400	646	85	1542	24500	0.874	0.227	125	0.0500	0.0160	W88
➤ MCC720-14io7	1400	719	85	1633	28000	0.823	0.241	125	0.0500	0.0160	W88
➤ MCC720-18io7	1800	719	85	1633	28000	0.823	0.241	125	0.0500	0.0160	W88
➤ MCR720-14io7	1400	719	85	1633	28000	0.823	0.241	125	0.0500	0.0160	W88
➤ MCR720-18io7	1800	719	85	1633	28000	0.823	0.241	125	0.0500	0.0160	W88

Outlines on pages O-01...O-29

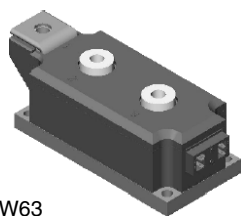

W63

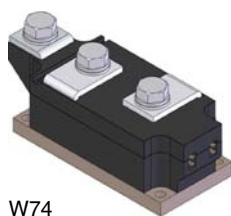

W74

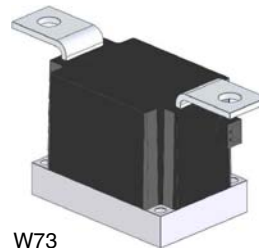

W73

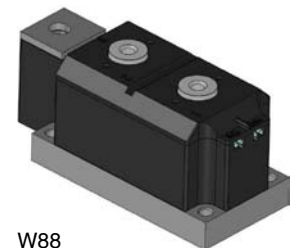

W88

# Single Thyristor Modules

Type	$V_{RRM}$	$I_{TAV}$	@ $T_C$	$I_{TRMS}$	$I_{TSM}$	$V_{TO}$	$r_T$	$T_{VJM}$	$R_{thJC}$	$R_{thCH}$	Fig. No.
	$V_{DRM}$										
➤ New	V	A	°C	A	A	V	mΩ	°C	K/W	K/W	
MCO741-22io1	2200	765	85	2315	29000	0.850	0.210	125	0.042	0.0100	W73
MCO801-14io1	1400	830	85	2530	30000	0.800	0.170	125	0.042	0.0100	W73
MCO801-18io1	1800	830	85	2530	30000	0.800	0.170	125	0.042	0.0100	W73

# Thyristor / Diode Modules

IXYS UK Westcode Ltd. has UL Certification for most modules (Underwriters Laboratories Inc). See the UL Listing.

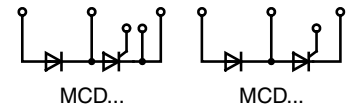

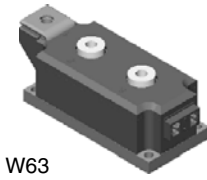
Part No.  ○ Not for new design ➤ New	$V_{RRM}$ $V_{DRM}$	$I_{TAV}$	@ $T_C$	$I_{TRMS}$	$I_{TSM}$ 125°C 10 ms	$V_{TO}$	$r_T$	$T_{VJM}$	per die		Fig. No.	Package style  Outline drawings on page O-01...O-29
	V	A	°C	A	A	V	mΩ	°C	K/W	K/W		
MCD320-30io2	3000	327	85	765	5000	1.150	0.800	125	0.065	0.0200	W74	 W63
MCD320-36io2	3600	327	85	765	5000	1.150	0.800	125	0.065	0.0200	W74	
MDC320-30io2	3000	327	85	765	5000	1.150	0.800	125	0.065	0.0200	W74	
MDC320-36io2	3600	327	85	765	5000	1.150	0.800	125	0.065	0.0200	W74	
MCD431-20io2	2000	429	85	1020	10900	1.000	0.410	125	0.062	0.0200	W74	
MCD431-22io2	2200	429	85	1020	10900	1.000	0.410	125	0.062	0.0200	W74	
MCD431-24io2	2400	429	85	1020	10900	1.000	0.410	125	0.062	0.0200	W74	
MDC431-20io2	2000	429	85	1020	10900	1.000	0.410	125	0.062	0.0200	W74	
MDC431-22io2	2200	429	85	1020	10900	1.000	0.410	125	0.062	0.0200	W74	
MDC431-24io2	2400	429	85	1020	10900	1.000	0.410	125	0.062	0.0200	W74	
○ MCD500-14io1	1400	500	89	1294	16500	0.820	0.270	125	0.062	0.0200	W63	
○ MCD500-18io1	1800	500	89	1294	16500	0.820	0.270	125	0.062	0.0200	W63	
○ MCD500-22io1	2200	500	80	1071	14000	0.880	0.460	125	0.062	0.0200	W63	
○ MDC500-14io1	1400	500	89	1294	16500	0.820	0.270	125	0.062	0.0200	W63	
○ MDC500-18io1	1800	500	89	1294	16500	0.820	0.270	125	0.062	0.0200	W63	
○ MDC500-22io1	2200	500	80	1071	14000	0.880	0.460	125	0.062	0.0200	W63	
MCD501-12io2	1200	503	85	1195	14500	0.850	0.300	125	0.062	0.0200	W74	
MCD501-14io2	1400	503	85	1195	14500	0.850	0.300	125	0.062	0.0200	W74	
MCD501-16io2	1600	503	85	1195	14500	0.850	0.300	125	0.062	0.0200	W74	
MCD501-18io2	1800	503	85	1195	14500	0.850	0.300	125	0.062	0.0200	W74	
MDC501-12io2	1200	503	85	1195	14500	0.850	0.300	125	0.062	0.0200	W74	
MDC501-14io2	1400	503	85	1195	14500	0.850	0.300	125	0.062	0.0200	W74	
MDC501-16io2	1600	503	85	1195	14500	0.850	0.300	125	0.062	0.0200	W74	
MDC501-18io2	1800	503	85	1195	14500	0.850	0.300	125	0.062	0.0200	W74	
➤ MCD552-12io2	1200	550	85	1300	15800	0.770	0.259	125	0.062	0.0200	W74	
➤ MCD552-14io2	1400	550	85	1300	15800	0.770	0.259	125	0.062	0.0200	W74	
➤ MCD552-16io2	1600	550	85	1300	15800	0.770	0.259	125	0.062	0.0200	W74	
➤ MDC552-12io2	1200	550	85	1300	15800	0.770	0.259	125	0.062	0.0200	W74	
➤ MDC552-14io2	1400	550	85	1300	15800	0.770	0.259	125	0.062	0.0200	W74	
➤ MDC552-16io2	1600	550	85	1300	15800	0.770	0.259	125	0.062	0.0200	W74	
➤ MCD500-30io7	3000	500	85	1181	18000	1.079	0.422	125	0.05	0.0160	W88	
➤ MCD500-36io7	3600	500	85	1181	18000	1.079	0.422	125	0.05	0.0160	W88	
➤ MDC500-30io7	3000	500	85	1181	18000	1.079	0.422	125	0.05	0.0160	W88	
➤ MDC500-36io7	3600	500	85	1181	18000	1.079	0.422	125	0.05	0.0160	W88	
➤ MCD580-28io7	2800	581	85	1372	21000	0.926	0.313	125	0.05	0.0160	W88	
➤ MDC580-28io7	2800	581	85	1372	21000	0.926	0.313	125	0.05	0.0160	W88	
➤ MCD650-24io7	2400	646	85	1542	24500	0.874	0.227	125	0.05	0.0160	W88	
➤ MDC650-24io7	2400	646	85	1542	24500	0.874	0.227	125	0.05	0.0160	W88	
➤ MCD720-14io7	1400	719	85	1633	28000	0.823	0.241	125	0.05	0.0160	W88	
➤ MCD720-18io7	1800	719	85	1633	28000	0.823	0.241	125	0.05	0.0160	W88	
➤ MDC720-14io7	1400	719	85	1633	28000	0.823	0.241	125	0.05	0.0160	W88	
➤ MDC720-18io7	1800	719	85	1633	28000	0.823	0.241	125	0.05	0.0160	W88	



# Dual Diode Modules

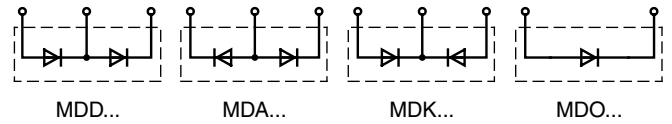

IXYS UK Westcode Ltd. has UL Certification for most modules (Underwriters Laboratories Inc). See the UL Listing.

Part No.	V <sub>RRM</sub>	I <sub>FAV</sub>	@ T <sub>C</sub>	I <sub>FRMS</sub>	I <sub>FSM</sub> 150°C 10 ms	V <sub>T0</sub>	r <sub>T</sub>	T <sub>VJM</sub>	R <sub>thJC</sub>	R <sub>thCK</sub>	Fig. No.
○ Not for new design									per die		
➤ New	V	A	°C	A	A	V	mΩ	°C	K/W	K/W	
○ MDD600-14N1	1400	600	111	1818	21800	0.750	0.200	150	0.0620	0.0200	W63
○ MDD600-18N1	1800	600	111	1818	21800	0.750	0.200	150	0.0620	0.0200	W63
○ MDD600-22N1	2200	600	111	1818	21800	0.750	0.200	150	0.0620	0.0200	W63
○ MDA600-14N1	1400	600	111	1818	21800	0.750	0.200	150	0.0620	0.0200	W63
○ MDA600-18N1	1800	600	111	1818	21800	0.750	0.200	150	0.0620	0.0200	W63
○ MDA600-22N1	2200	600	111	1818	21800	0.750	0.200	150	0.0620	0.0200	W63
○ MDK600-14N1	1400	600	111	1818	21800	0.750	0.200	150	0.0620	0.0200	W63
○ MDK600-18N1	1800	600	111	1818	21800	0.750	0.200	150	0.0620	0.0200	W63
○ MDK600-22N1	2200	600	111	1818	21800	0.750	0.200	150	0.0620	0.0200	W63
➤ MDD630-30N2	3000	632	85	1273	11800	0.800	0.500	150	0.0620	0.0200	W74
➤ MDD630-36N2	3600	632	85	1273	11800	0.800	0.500	150	0.0620	0.0200	W74
➤ MDA630-30N2	3000	632	85	1273	11800	0.800	0.500	150	0.0620	0.0200	W74
➤ MDA630-36N2	3600	632	85	1273	11800	0.800	0.500	150	0.0620	0.0200	W74
➤ MDK630-30N2	3000	632	85	1273	11800	0.800	0.500	150	0.0620	0.0200	W74
➤ MDK630-36N2	3600	632	85	1273	11800	0.800	0.500	150	0.0620	0.0200	W74
➤ MDD 710-22N2	2200	708	85	1440	12750	0.800	0.350	150	0.0620	0.0200	W74
➤ MDD 710-26N2	2600	708	85	1440	12750	0.800	0.350	150	0.0620	0.0200	W74
➤ MDA 710-22N2	2200	708	85	1440	12750	0.800	0.350	150	0.0620	0.0200	W74
➤ MDA 710-26N2	2600	708	85	1440	12750	0.800	0.350	150	0.0620	0.0200	W74
➤ MDK 710-22N2	2200	708	85	1440	12750	0.800	0.350	150	0.0620	0.0200	W74
➤ MDK 710-26N2	2600	708	85	1440	12750	0.800	0.350	150	0.0620	0.0200	W74
➤ MDD 810-12N2	1200	807	85	1661	17250	0.780	0.230	150	0.0620	0.0200	W74
➤ MDD 810-16N2	1600	807	85	1661	17250	0.780	0.230	150	0.0620	0.0200	W74
➤ MDD 810-18N2	1800	807	85	1661	17250	0.780	0.230	150	0.0620	0.0200	W74
➤ MDA 810-12N2	1200	807	85	1661	17250	0.780	0.230	150	0.0620	0.0200	W74
➤ MDA 810-16N2	1600	807	85	1661	17250	0.780	0.230	150	0.0620	0.0200	W74
➤ MDA 810-18N2	1800	807	85	1661	17250	0.780	0.230	150	0.0620	0.0200	W74
➤ MDK 810-12N2	1200	807	85	1661	17250	0.780	0.230	150	0.0620	0.0200	W74
➤ MDK 810-16N2	1600	807	85	1661	17250	0.780	0.230	150	0.0620	0.0200	W74
➤ MDK 810-18N2	1800	807	85	1661	17250	0.780	0.230	150	0.0620	0.0200	W74
➤ MDD1080-18N7	1800	1080	85	2235	32000	0.782	0.157	150	0.0500	0.0160	W88
➤ MDD1080-24N7	2400	1080	85	2235	32000	0.782	0.157	150	0.0500	0.0160	W88
➤ MDD1080-28N7	2800	1080	85	2235	32000	0.782	0.157	150	0.0500	0.0160	W88
➤ MDA1080-18N7	1800	1080	85	2235	32000	0.782	0.157	150	0.0500	0.0160	W88
➤ MDA1080-24N7	2400	1080	85	2235	32000	0.782	0.157	150	0.0500	0.0160	W88
➤ MDA1080-28N7	2800	1080	85	2235	32000	0.782	0.157	150	0.0500	0.0160	W88
➤ MDK1080-18N7	1800	1080	85	2235	32000	0.782	0.157	150	0.0500	0.0160	W88
➤ MDK1080-24N7	2400	1080	85	2235	32000	0.782	0.157	150	0.0500	0.0160	W88
➤ MDK1080-28N7	2800	1080	85	2235	32000	0.782	0.157	150	0.0500	0.0160	W88

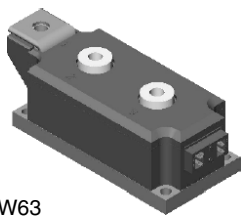

W63

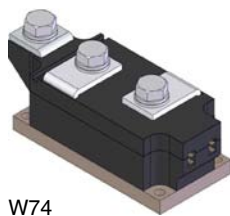

W74

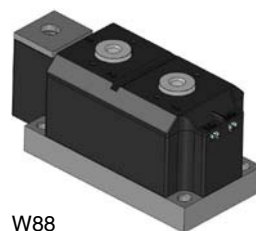

W88

Outlines on pages O-01...O-29

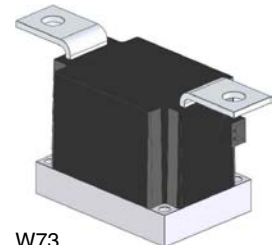

W73

# Single Diode Modules

IXYS UK Westcode Ltd. has UL Certification for most modules (Underwriters Laboratories Inc).

Part No.	V <sub>RRM</sub>	I <sub>FAV</sub>	@ T <sub>C</sub>	I <sub>FRMS</sub>	I <sub>FSM</sub> 150°C 10 ms	V <sub>T0</sub>	r <sub>T</sub>	T <sub>VJM</sub>	R <sub>thJC</sub>	R <sub>thCK</sub>	Fig. No.
➤ New	V	A	°C	A	A	V	mΩ	°C	K/W	K/W	
➤ MDO1201-14N1	1400	1520	85	3665	36000	0.800	0.100	160	0.0420	0.0100	W73
➤ MDO1201-18N1	1800	1520	85	3665	36000	0.800	0.100	160	0.0420	0.0100	W73
➤ MDO1201-22N1	2200	1520	85	3665	36000	0.800	0.100	160	0.0420	0.0100	W73

## Water Cooled Dual Diode Modules

IXYS UK's range of water cooled modules feature a direct cooled base, with no extra interface to the die allowing for more efficient cooling giving an enhanced average current rating.

IXYS UK Westcode Ltd has UL Certification for most modules (Underwriters Laboratories Inc).  
See the UL Listing.

Part No.	$V_{RRM}$	$I_{FAV}$	@ $T_C$	$I_{FRMS}$	$I_{FSM}$ 150°C 10ms	$V_{TO}$	$r_T$	$T_{VJM}$	$R_{thJW}$ per die	Fig. No.	Package style  Outline drawings on page O-01...O-29
	V	A	°C	A	A	V	mΩ	°C	K/W		
<b>MDD950-14N1W</b>	1400	950	45	1773	21800	0.750	0.200	150	0.0900	W64	
<b>MDD950-18N1W</b>	1800	950	45	1773	21800	0.750	0.200	150	0.0900	W64	
<b>MDD950-22N1W</b>	2200	950	45	1773	21800	0.750	0.200	150	0.0900	W64	
<b>MDA950-14N1W</b>	1400	950	45	1773	21800	0.750	0.200	150	0.0900	W64	
<b>MDA950-18N1W</b>	1800	950	45	1773	21800	0.750	0.200	150	0.0900	W64	
<b>MDA950-22N1W</b>	2200	950	45	1773	21800	0.750	0.200	150	0.0900	W64	
<b>MDK950-14N1W</b>	1400	950	45	1773	21800	0.750	0.200	150	0.0900	W64	
<b>MDK950-18N1W</b>	1800	950	45	1773	21800	0.750	0.200	150	0.0900	W64	
<b>MDK950-22N1W</b>	2200	950	45	1773	21800	0.750	0.200	150	0.0900	W64	

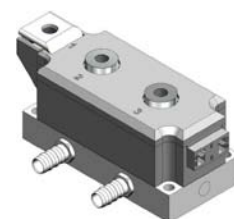

W64

## Water Cooled Thyristor/Diode Modules

Part No.	$V_{RRM}$ $V_{DRM}$	$I_{TAV}$	@ $T_C$	$I_{TRMS}$	$I_{TSM}$ 125°C 10ms	$V_{TO}$	$r_T$	$T_{VJM}$	$R_{thJW}$ per die	Fig. No.
	V	A	°C	A	A	V	mΩ	°C	K/W	
<b>MCD600-22io1W</b>	2200	600	40	1116	16500	0.880	0.460	125	0.0900	W64
<b>MDC600-22io1W</b>	2200	600	40	1116	16500	0.880	0.460	125	0.0900	W64
<b>MCD700-14io1W</b>	1400	700	42	1331	16500	0.850	0.270	125	0.0900	W64
<b>MCD700-18io1W</b>	1800	700	42	1331	16500	0.850	0.270	125	0.0900	W64
<b>MDC700-14io1W</b>	1400	700	42	1331	16500	0.850	0.270	125	0.0900	W64
<b>MDC700-18io1W</b>	1800	700	42	1331	16500	0.850	0.270	125	0.0900	W64

## Water Cooled Dual Thyristor Modules

Part No.	$V_{RRM}$ $V_{DRM}$	$I_{TAV}$	@ $T_C$	$I_{TRMS}$	$I_{TSM}$ 125°C 10ms	$V_{TO}$	$r_T$	$T_{VJM}$	$R_{thJW}$ per die	Fig. No.
	V	A	°C	A	A	V	mΩ	°C	K/W	
<b>MCA600-22io1W</b>	2200	600	40	1116	16500	0.880	0.460	125	0.0900	W64
<b>MCC600-22io1W</b>	2200	600	40	1116	16500	0.880	0.460	125	0.0900	W64
<b>MCK600-22io1W</b>	2200	600	40	1116	16500	0.880	0.460	125	0.0900	W64
<b>MCC700-14io1W</b>	1400	700	42	1331	16500	0.850	0.270	125	0.0900	W64
<b>MCC700-18io1W</b>	1800	700	42	1331	16500	0.850	0.270	125	0.0900	W64
<b>MCA700-14io1W</b>	1400	700	42	1331	16500	0.850	0.270	125	0.0900	W64
<b>MCA700-18io1W</b>	1800	700	42	1331	16500	0.850	0.270	125	0.0900	W64
<b>MCK700-14io1W</b>	1400	700	42	1331	16500	0.850	0.270	125	0.0900	W64
<b>MCK700-18io1W</b>	1800	700	42	1331	16500	0.850	0.270	125	0.0900	W64

# Power Semiconductor Assemblies from IXYS UK

## Power Semiconductor Assemblies

From discrete devices to complete assemblies, our customers can procure our products in whatever form suits their needs on a global basis. Supply management is critical to every manufacturer and reducing costs without compromising quality is essential. Our experienced, international, team of engineers is on hand to help our customers to get more from their products and keep at the forefront of technology in an increasingly competitive marketplace.

### Standard Assemblies

We have a comprehensive range of standard assemblies for all of the common converter topologies utilising either natural air, forced air or liquid cooling. These well-proven designs provide an economical alternative to in house design and assembly of discrete parts. These assemblies are available on short lead-times to suit most common line voltages and current ratings from 35 A to 15 kA.

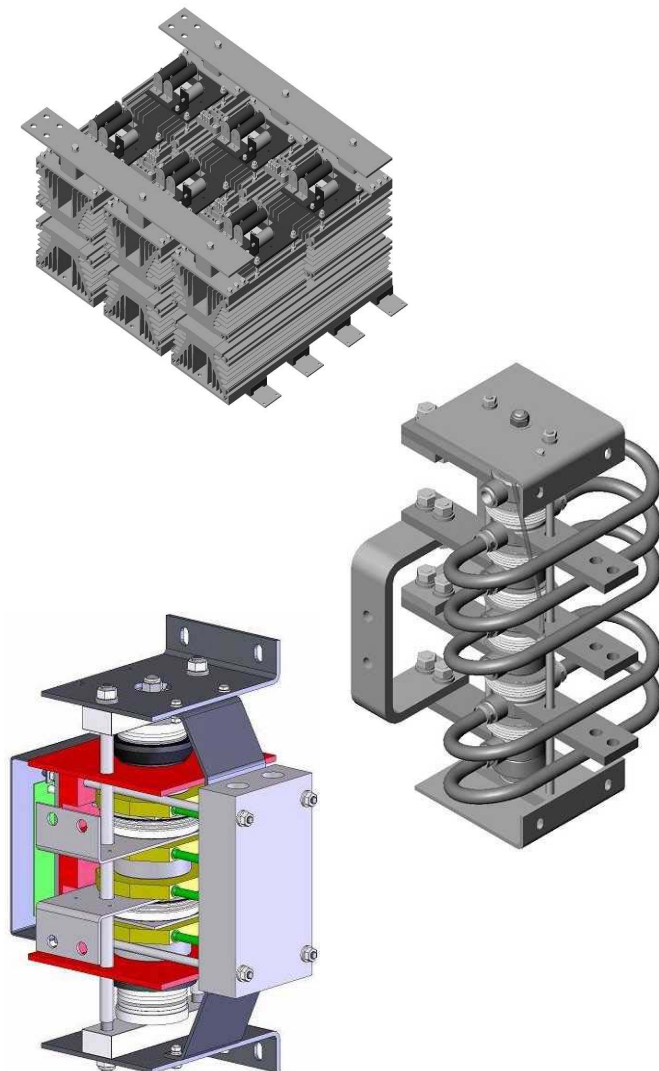

### Custom Assemblies

With over 70 years of experience in power circuit design and manufacture, our dedicated team of design engineers can deliver custom solutions for a whole range of design problems ranging from simple crowbar applications to complicated multi-megawatt power converters. Utilising the latest 3D modeling techniques, we can reduce the cycle time from concept to manufacture and ensure successful system level integration into our customers equipment.

### Pulsed Power

As a pioneer in the development of solid state pulsed power components and systems, we are able to deliver anything from discrete components to fully integrated energy transfer switches. With systems successfully delivering voltage ratings of over 50 kV and pulsed currents to 140 kA, we have wealth of experience to put at your disposal. Our modular design solutions based on either pulse thyristor or press-pack IGBT technology and integrating control and protection functions provide you with a flexible “black box” approach to energy transfer problems.

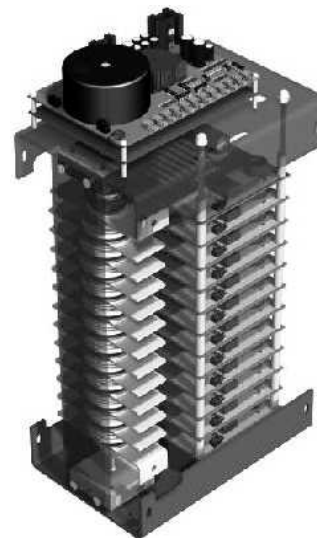

We are involved with pulsed power on global basis, working with prestigious research organisations such as CERN, Switzerland as well as medium volume manufacture for emerging commercial applications such as laser supplies, PUV and PEF sterilisation, magnetisation and metal forming.

We have a philosophy of working closely with our customers to ensure that we deliver the right solution in the right time and right price – first time and every time.

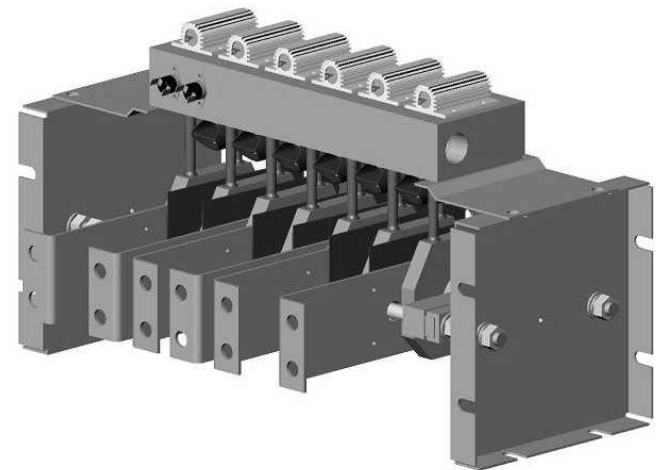

# Power Semiconductor Assemblies

## Transportation

We have a long association with the railway industry and over the years have gained an enviable reputation within railway industry as a solution provider. Using our experience and wide ranging contacts within the industry, we are able to offer assistance in tackling issues such as component obsolescence, improving power equipment reliability, contract maintenance of power modules, refurbishment of power electronics and upgrades to existing systems.

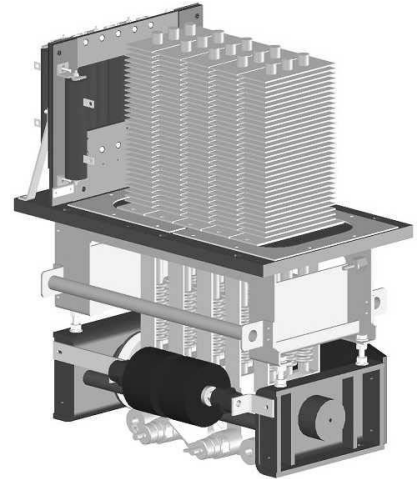
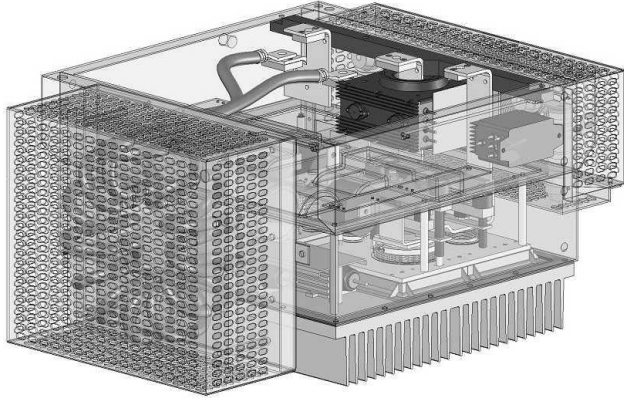

Working systematically to the highest international standards, we can give your equipment a new lease of life and help protect your investment in these valuable assets. For larger projects, such as fleet wide re-fits, we are able to work within a consortium of specialist companies to ensure that you have the right skills to hand to deliver a turnkey solution to your requirements.

## Silicon Assemblies

A wide range of units is available, incorporating international standard outline silicon semiconductor. IXYS UK products have gained a worldwide reputation for quality in military, industrial and domestic applications.

Standard extruded aluminium heatsink profiles are used for mounting discrete semiconductor devices in various configurations, for example:

- Single-phase diode bridges with current ratings from 70 to 5170 Amps DC
- Single-phase half or fully controlled bridges from 35 to 2200 Amps DC
- Three-phase diode bridges with current ratings from 100 to 7190 Amps DC
- Three-phase half or fully controlled bridges from 45 to 3790 Amps DC
- Hexaphase single way diode assemblies from 200 to 14380 Amps DC
- Hexaphase single way Thyristor assemblies from 90 to 7580 Amps DC
- AC Regulators, single and three phase, from 40 to 2940 Amps RMS

## Water Cooled AC Regulators

Included in our standard range are solid state, water cooled AC Regulators for resistance welding, with ratings from 315 to 3020 Amps RMS.

Also available are water cooled, single and three phase assemblies from 1200 to 6000 Amps DC.

All the above range is suitable for 440 V<sub>RMS</sub> 50Hz mains operation.

## Beyond Semiconductors

Our flexible manufacturing facility is able to readily adapt to our customers needs. In addition to power semiconductor assembly, we can offer complementary sub-assemblies to our customer's requirements, such as fuse panels and capacitor banks as well as contract manufacture to your designs.

## Application and Engineering Support

Our highly experienced technical team is on hand to provide our customers with first class support for everything from the application of our range of discrete devices to the design and development of complex systems. We can help you from concept through design to manufacture and test, working closely with you at every step of the way.

## Components

We offer a full portfolio of components which are complementary to our range of power semiconductors including:

Heatsinks      Coolers      Mounting Clamps  
Ultra Rapid Semiconductor Protection Fuses  
Capacitors for Power Electronics  
Gate Drive Units

# Westack - Modular Solutions

## Single phase diode bridges

Approx. total loss  $2 \cdot I_{DC}$  @ 25°C

Assembly Part Number	I <sub>DC</sub> amps Air Forced 2.5m/s			I <sub>FSM</sub> amps I <sub>TSM</sub> amps	I <sup>2</sup> t A <sup>2</sup> s	Dimensions mm			Mass kg	Device Type and Quantity	Heat Sink Type	
	T <sub>a</sub> = 25°C	T <sub>a</sub> = 35°C	T <sub>a</sub> = 45°C			Fig.	W	H				
SXB1375B	1375	1303	1230	19500	1.9x10 <sup>6</sup>	1	382	325	405	20	W2058LC (4)	B(2x83,1x180)
SXB2096B	2096	1987	1874	33000	5.45x10 <sup>6</sup>	1	382	325	405	20	W3270NC (4)	B(2x83,1x180)
SXB3442B	3442	3277	3109	53000	13.5x10 <sup>6</sup>	2	382	593	405	40	W5696VC (4)	B(2x180)
SXB4264B	4264	4051	3835	72000	22.5x10 <sup>6</sup>	2	382	593	405	40	W8405ZC (4)	B(2x180)

## Three phase diode bridges

Approx. total loss  $2.5 \cdot I_{DC}$  @ 25°C

Assembly Part Number	I <sub>DC</sub> amps Air Forced 2.5m/s			I <sub>FSM</sub> amps I <sub>TSM</sub> amps	I <sup>2</sup> t A <sup>2</sup> s	Dimensions mm			Mass kg	Device Type and Quantity	Heat Sink Type	
	T <sub>a</sub> = 25°C	T <sub>a</sub> = 35°C	T <sub>a</sub> = 45°C			Fig.	W	H				
SXB1920G	1920	1822	1721	19500	1.9x10 <sup>6</sup>	3	548	325	405	30	W2058LC (6)	B(2x83,1x180)
SXB2939G	2939	2788	2634	33000	5.45x10 <sup>6</sup>	3	548	325	405	30	W3270NC (6)	B(2x83,1x180)
SXB4869G	4869	4640	4407	53000	13.5x10 <sup>6</sup>	4	548	593	405	60	W5696VC (6)	B(2x180)
SXB5993G	5993	5701	5402	72000	22.5x10 <sup>6</sup>	4	548	593	405	60	W8405ZC (6)	B(2x180)

## Six phase diode, single way with IPT

Approx. total loss  $1.25 \cdot I_{DC}$  @ 25°C

Assembly Part Number	I <sub>DC</sub> amps Air Forced 2.5m/s			I <sub>FSM</sub> amps I <sub>TSM</sub> amps	I <sup>2</sup> t A <sup>2</sup> s	Dimensions mm			Mass kg	Device Type and Quantity	Heat Sink Type	
	T <sub>a</sub> = 25°C	T <sub>a</sub> = 35°C	T <sub>a</sub> = 45°C			Fig.	W	H				
SXB3840HEX	3840	3644	3442	19500	1.9x10 <sup>6</sup>	5	548	325	395	30	W2058LC (6)	B(2x83,1x180)
SXB5877HEX	5877	5576	5268	33000	5.45x10 <sup>6</sup>	5	548	325	395	30	W3270NC (6)	B(2x83,1x180)
SXB9737HEX	9737	9281	8813	53000	13.5x10 <sup>6</sup>	6	548	593	395	60	W5696VC (6)	B(2x180)
SXB11987HEX	11987	11401	10804	72000	22.5x10 <sup>6</sup>	6	548	593	395	60	W8405ZC (6)	B(2x180)

## Six phase thyristor, single way with IPT

Approx. total loss  $1.5 \cdot I_{DC}$  @ 25°C

Assembly Part Number	I <sub>DC</sub> amps Air Forced 2.5m/s			I <sub>FSM</sub> amps I <sub>TSM</sub> amps	I <sup>2</sup> t A <sup>2</sup> s	Dimensions mm			Mass kg	Device Type and Quantity	Heat Sink Type	
	T <sub>a</sub> = 25°C	T <sub>a</sub> = 35°C	T <sub>a</sub> = 45°C			Fig.	W	H				
SXB2428HEXT	2428	2233	2030	15000	1.13x10 <sup>6</sup>	5	548	325	395	30	N1265LC (6)	B(2x83,1x180)
SXB3529HEXT	3529	3244	2949	29600	4.38x10 <sup>6</sup>	5	548	325	395	30	N1802LC (6)	B(2x83,1x180)
SXB4649HEXT	4649	4270	3878	37000	6.85x10 <sup>6</sup>	6	548	593	395	60	N2500VC (6)	B(2x180)
SXB6240HEXT	6240	5714	5173	64000	20.5x10 <sup>6</sup>	6	548	593	395	60	N4085ZC (6)	B(2x180)

## Single phase fully controlled bridges

Approx. total loss  $2.5xI_{DC}$  @ 25°C

Assembly Part Number	I <sub>DC</sub> amps Air Forced 2.5m/s			I <sub>FSM</sub> amps I <sub>TSM</sub> amps	I <sup>2</sup> t A <sup>2</sup> s	Dimensions mm			Mass kg	Device Type and Quantity	Heat Sink Type	
	T <sub>a</sub> = 25°C	T <sub>a</sub> = 35°C	T <sub>a</sub> = 45°C			Fig.	W	H				
SXB868FB	868	797	724	15000	1.13x10 <sup>6</sup>	1	382	325	405	20	N1265NC (4)	B(2x83,1x180)
SXB1265FB	1265	1161	1054	29600	4.38x10 <sup>6</sup>	1	382	325	405	20	N1802NC (4)	B(2x83,1x180)
SXB1645FB	1645	1508	1367	37000	6.85x10 <sup>6</sup>	2	382	593	405	40	N2500VC (4)	B(2x180)
SXB2167FB	2167	1981	1790	64000	20.5x10 <sup>6</sup>	2	382	593	405	40	N4085ZC (4)	B(2x180)

## Three phase fully controlled bridges

Approx. total loss  $3 \cdot I_{DC}$  @ 25°C

Assembly Part Number	I <sub>DC</sub> amps Air Forced 2.5m/s			I <sub>FSM</sub> amps I <sub>TSM</sub> amps	I <sup>2</sup> t A <sup>2</sup> s	Dimensions mm			Mass kg	Device Type and Quantity	Heat Sink Type	
	T <sub>a</sub> = 25°C	T <sub>a</sub> = 35°C	T <sub>a</sub> = 45°C			Fig.	W	H				
SXB1214FG	1214	1116	1015	15000	1.13x10 <sup>6</sup>	3	548	325	405	30	N1265NC (6)	B(2x83,1x180)
SXB1764FG	1764	1622	1475	29600	4.38x10 <sup>6</sup>	3	548	325	405	30	N1802NC (6)	B(2x83,1x180)
SXB2324FG	2324	2135	1939	37000	6.85x10 <sup>6</sup>	4	548	593	405	60	N2500VC (6)	B(2x180)
SXB3120FG	3120	2857	2586	64000	20.5x10 <sup>6</sup>	4	548	593	405	60	N4085ZC (6)	B(2x180)



Figure 1



Figure 4



Figure 2

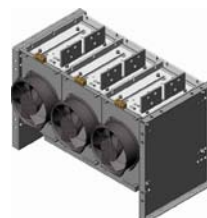

Figure 5



Figure 3



Figure 6

# Westack - Modular Solutions

Cooling for each module section is provided by the use of a low noise 115/230 V ac fan which is protected against overloading by an integral thermal cut-out.

Surge suppression and fusing provides reliable and safe operation. Surge suppression (protecting the devices from voltage transients) and high speed fuses (to protect against short circuit) are available. Contact IXYS UK for details.

All plastic components are UL recognised and meet the requirements of the European Union Directive 2002/95/EC covering the restricted use of certain hazardous substances in electrical and electronic equipment.

ISO 9000 provides the standard against which all our products and services are measured.

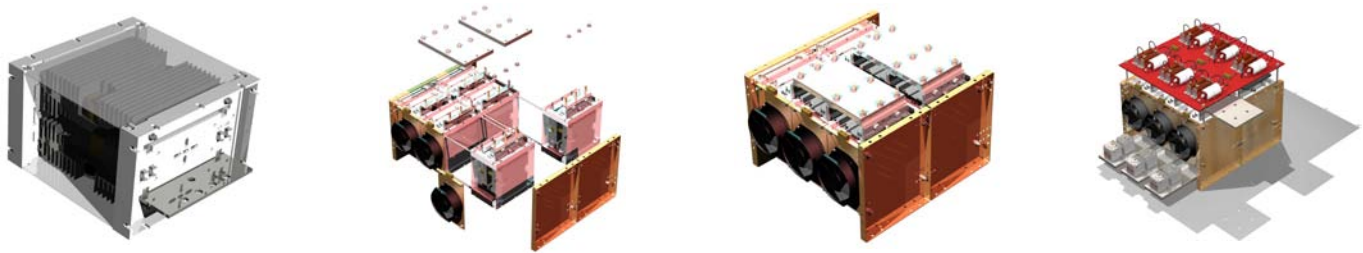

**Westack - Modular Solutions are available in 6 standard configurations, others by request.**



Figure 1  
Weight 20 kg



Figure 2  
Weight 40 kg



Figure 3  
Weight 20 kg



Figure 4  
Weight 60 kg

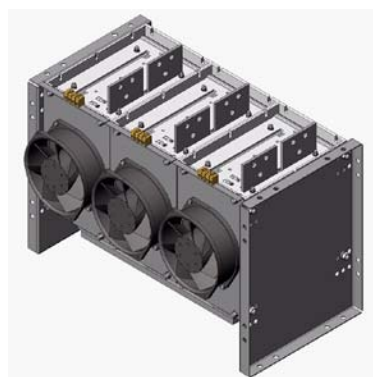

Figure 5  
Weight 30 kg



Figure 6  
Weight 60 kg

## WestackLITE - Modular Solutions

A simple but highly efficient range of stacks incorporating the new **WESPACK** range of phase control thyristors.

Currently available in 3 standard configurations:

AC voltage regulators

Single-phase bridges

Three-phase bridges

These stacks can easily be modified to meet individual customer requirements.

Fully dimensioned drawings are available upon request from the Chippenham Factory.

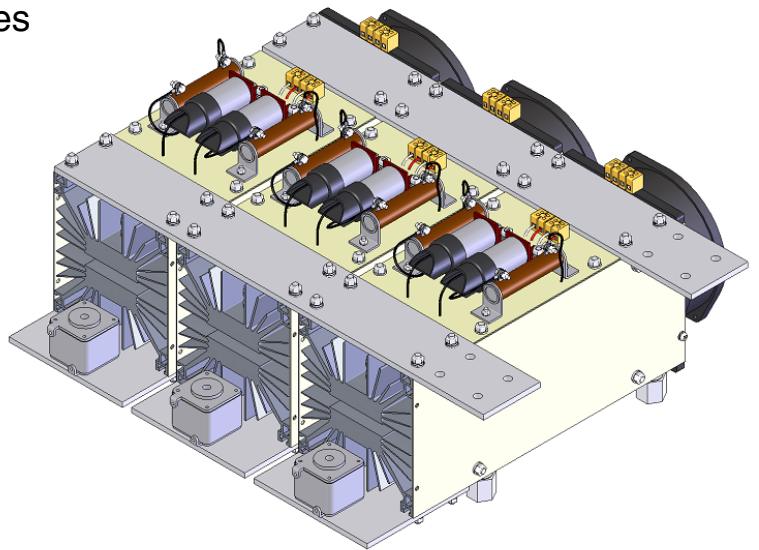

### Features and Benefits

**WESPACK** devices provide the maximum power rating for weight and volume without compromising on quality and reliability.



Cooling is provided by means of a low noise dual voltage (230V/115V) ac fan that is protected against overloading by an integral thermal cut-out.

Surge suppression and fusing can be added to protect the devices from voltage transients and short circuits.

ISO 9000 2000 provides the standard against which all our products and services are measured.

**AC regulators**

**Approx. total loss  $1.3 \cdot I_{RMS}$**

Assembly Part Number	I <sub>DC</sub> amps Air Forced 5m/s			I <sub>FSM</sub> amps	I <sup>2</sup> t A <sup>2</sup> s	Dimensions mm				Mass kg	Device Type and Quantity	Heat Sink Type
	T <sub>a</sub> = 25°C	T <sub>a</sub> = 35°C	T <sub>a</sub> = 45°C			Fig.	W	H	D			
<b>SXC1195FR</b>	1195	1098	997	19100	1.82x10 <sup>6</sup>	1	168	415	212	10	N1806QK (2)	(2x150, 1x330)
<b>SXC1464FR</b>	1464	1348	1227	32400	5.25x10 <sup>6</sup>	1	168	415	212	10	N2367MK (2)	(2x150, 1x330)
<b>SXC1788FR</b>	1788	1636	1480	50900	12.95x10 <sup>6</sup>	1	168	415	212	10	N3904HK (2)	(2x150, 1x330)

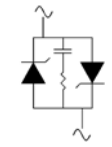

**Single phase fully controlled bridges**

**Approx. total loss  $2.5 \cdot I_{DC}$**

Assembly Part Number	I <sub>DC</sub> amps Air Forced 2.5m/s			I <sub>FSM</sub> amps	I <sup>2</sup> t A <sup>2</sup> s	Dimensions mm				Mass kg	Device Type and Quantity	Heat Sink Type
	T <sub>a</sub> = 25°C	T <sub>a</sub> = 35°C	T <sub>a</sub> = 45°C			Fig.	W	H	D			
<b>SXC1076FB</b>	1076	988	897	19100	1.82x10 <sup>6</sup>	2	330	415	212	20	N1806QK (4)	(2x150, 1x330)
<b>SXC1318FB</b>	1318	1213	1104	32400	5.25x10 <sup>6</sup>	2	330	415	212	20	N2367MK (4)	(2x150, 1x330)
<b>SXC1609FB</b>	1609	1473	1332	50900	12.95x10 <sup>6</sup>	2	330	415	212	20	N3904HK (4)	(2x150, 1x330)

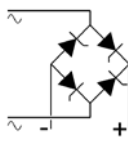

**Three phase fully controlled bridges**

**Approx. total loss  $3 \cdot I_{DC}$**

Assembly Part Number	I <sub>DC</sub> amps Air Forced 2.5m/s			I <sub>FSM</sub> amps	I <sup>2</sup> t A <sup>2</sup> s	Dimensions mm				Mass kg	Device Type and Quantity	Heat Sink Type
	T <sub>a</sub> = 25°C	T <sub>a</sub> = 35°C	T <sub>a</sub> = 45°C			Fig.	W	H	D			
<b>SXC1517FG</b>	1517	1396	1270	19100	1.82 x 10 <sup>6</sup>	3	492	415	212	30	N1806QK (6)	(2x150, 1x330)
<b>SXC1871FG</b>	1871	1725	1573	32400	5.25 x 10 <sup>6</sup>	3	492	415	212	30	N2367MK (6)	(2x150, 1x330)
<b>SXC2319FG</b>	2319	2125	1926	50900	12.95 x 10 <sup>6</sup>	3	492	415	212	30	N3904HK (6)	(2x150, 1x330)

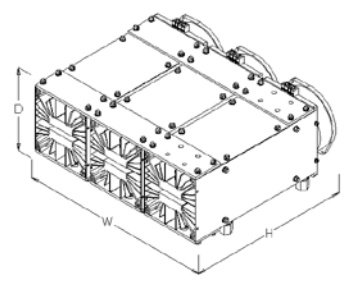
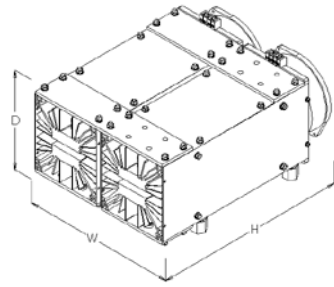
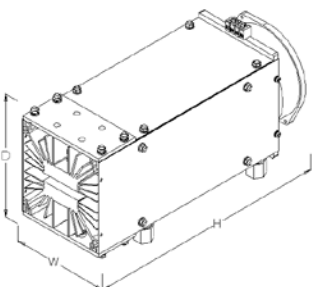
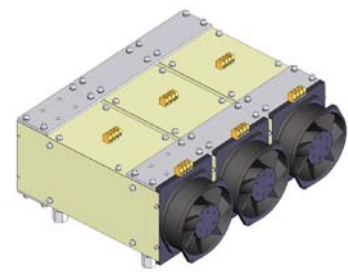
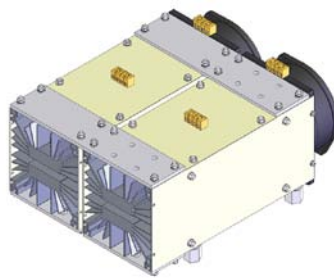
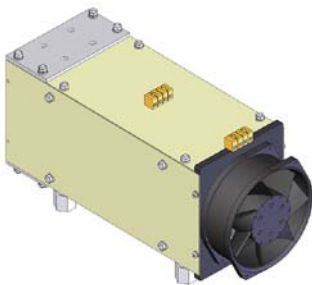
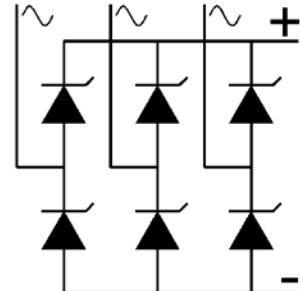
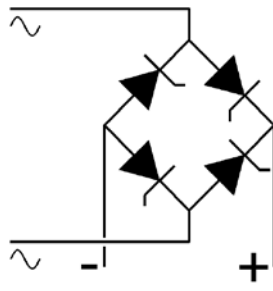
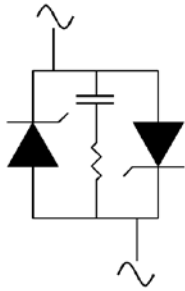
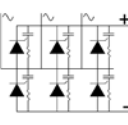

Figure 1  
Weight 10 kg

Figure 2  
Weight 20 kg

Figure 3  
Weight 30 kg



## Power Semiconductor Accessories

As part of our continuing commitment to meet our customers' demands, we offer a range of products to support our high power semiconductor devices and our silicon assembly business.

The following pages show a selection of accessories available to our customers, from heatsinks and coolers, to bar or box clamps, to mounting grease!

Part number	Old Part Number	Accessory
XSGSCX13	C7149	Press Pack Semiconductor Mounting Grease - supplied in 1kg tins
XST1000M08P	PTFE1000M8	M8 PTFE tube x 1m length insulation
XST1000M10P	PTFE1000M10	M10 PTFE tube x 1m length insulation
XST1000M12P	PTFE1000M12	M12 PTFE tube x 1m length insulation
XST1000M16P	PTFE1000M16	M16 PTFE tube x 1m length insulation
L0001YC600XXX	n/a	30mm diameter poleface Insulator Capsule
L0001QC600XXX	n/a	38mm diameter poleface Insulator Capsule
L0001NC600XXX	n/a	47mm diameter poleface Insulator Capsule
L0001HC600XXX	n/a	66mm diameter poleface Insulator Capsule
L0001ZF600XXX	n/a	73mm diameter poleface Insulator Capsule
L0001TC600XXX	n/a	75mm diameter poleface Insulator Capsule

Part number	Old Part Number	Accessory	Type
XSL200D8WRC	U9948	200mm long single Co-Axial cable, Red / White, M5 ring terminal for Ø75 IGBT & below	IGBT
XSL200D8WRCP	U9947	200mm long double Co-Axial cable, Red / White, M5 ring terminal for Ø85 IGBT & above	IGBT
XSL220C2WRT		220mm long twisted pair, Silicone sleeve cable 16/0.2, Red / White, M4 ring terminal	Thyristor
XSL300C2WRP	U9900	300mm long pair, Silicone sleeve cable 16/0.2, Red / White, M4 ring terminal	Thyristor
XSL300C2WS	U9900 (Gate Only)	300mm long gate wire, Silicone sleeve cable 16/0.2, White, M4 ring terminal	Thyristor
XSL350C2WRP	U9723	350mm long pair, Silicone sleeve cable 16/0.2, Red / White, M4 ring terminal	Thyristor
XSL400C2WRP	U9860	400mm long pair, Silicone sleeve cable 16/0.2, Red / White, M4 ring terminal	Thyristor
XSL500C2WRP	U9855	500mm long pair, Silicone sleeve cable 16/0.2, Red / White, M4 ring terminal	Thyristor
XSL600C2WRP	U9775	600mm long pair, Silicone sleeve cable 16/0.2, Red / White, M4 ring terminal	Thyristor
XSL1000C2WRP	U9734/U9801/U9849	1000mm long pair, Silicone sleeve cable 16/0.2, Red / White, M4 ring terminal	Thyristor
XSL1000C2WRT	U9952	1000mm long twisted pair, Silicone sleeve cable 16/0.2, Red / White, M4 ring terminal	Thyristor
XSL1100C2WRT	U9779	1100mm long twisted pair, Silicone sleeve cable 16/0.2, Red / White, M4 ring terminal	Thyristor

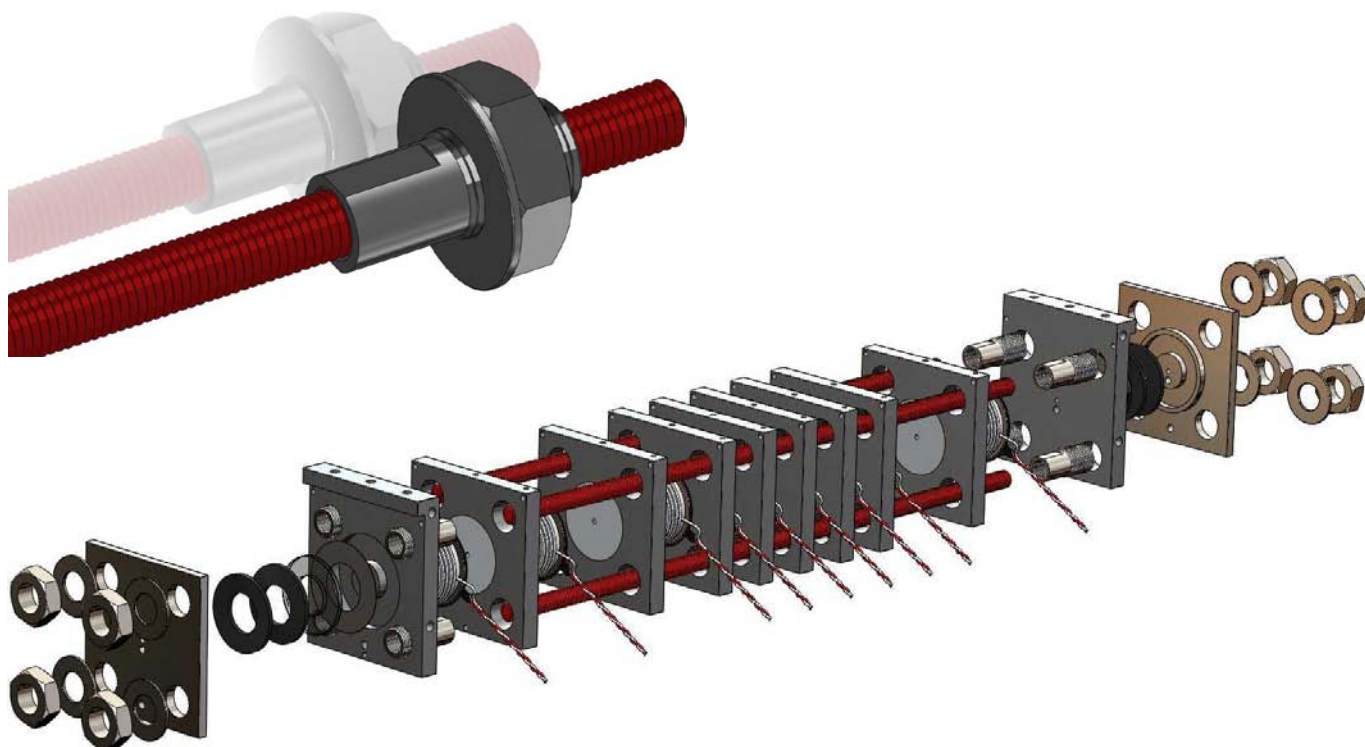

We can supply discrete parts, kits of parts or complete assemblies to satisfy your requirements. Please contact the Chippenham Factory for further information.

# Standard Bar Clamps

Part Number ○ Not for new design *	Fixing Centres mm	Rod Size	Capsule Device				Outline No.
			Outline	Mounting Surface Diameter mm	Nominal Thickness mm	T <sub>j</sub> Max °C	
XK0450DA056M XK0450DT056M XK0450SA056M	65	M8	DO-200AA / TO-200AB	19.0	13.8	190	WC2 WC3 WC1
XK0550DA056M XK0550SA056M	65	M8	GTO	29.5	16.0	190	WC5 WC4
○ XK0900DA056M ○ XK0900DT056M XK0900SA056M	65	M8	Diode / Thyristor	25.1	14.6	190	WC7 WC8 WC6
XK0600DA074M XK0600SA074M	89	M10	Press-Pack IGBTs	47.0	27.0	190	WC10 WC9
XK1000DA074M XK1000SA074M	89	M10	Press-Pack IGBTs	47.0	27.0	190	WC12 WC11
XK1100DA076M	89	M10	DO-200AB / TO-200AC	34.0	26.2	190	WC13
XK1130DA076M XK1130DT076M XK1130SA076M	89	M10	DO-200AB / TO-200AC	34.0	26.2	190	WC15 WC16 WC14
XK1800DA076M XK1800DT076M XK1800SA076M	89	M10	Wespack PCT	38.0	14.0	190	WC18 WC19 WC17
XK2100DA076M XK2100DA076ML XK2100SA076M XK2100SA076ML	89	M10	GTO	47.0	27.0	190 125 190 125	WC21 WC20
○ XK2140DA076M ○ XK2140DA076ML ○ XK2140DT076M ○ XK2140DT076ML XK2140SA076M XK2140SA076ML	89	M10	DO-200 / Thyristor	47.0	26.8	190 125 190 125 190 125	WC23 WC24 WC22
XK2700DA076M XK2700DT076M XK2700SA076M	89	M10	Wespack PCT	50.0	14.0	190	WC26 WC27 WC25
XK2000DA114M XK2000SA114M	132	M12	Press-Pack IGBTs	75.0	26.0	190	WC29 WC28
XK2500DA114M XK2500SA114M	132	M12	Press-Pack IGBTs	75.0	26.0	190	WC31 WC30
XK2500DA116M XK2500DA116ML XK2500SA116M XK2500SA116ML	132	M12	GTO	63.0	26.0	190 125 190 125	WC33 WC32
○ XK3000DA116M ○ XK3000DA116Mx XK3000SA116M XK3000SA116ML	132	M12	DO-200AD / Thyristor	63.0	33.0	190 125 190 125	WC35 WC34
XK3500DA116M XK3500DA116ML XK3500SA116M XK3500SA116ML	132	M12	GTO	75.0	26.0	190 125 190 125	WC37 WC36
○ XK4000DA116M ○ XK4000DA116ML XK4000SA116M XK4000SA116ML	132	M12	Diode / Thyristor	73.0	36.8	190 125 190 125	WC39 WC39

# Standard Bar Clamps

Part Number ○ Not for new design *	Fixing Centres mm	Rod Size	Capsule Device				Outline Ref.
			Outline	Mounting Surface Diameter mm	Nominal Thickness mm	T <sub>j</sub> Max °C	
XK5000DA128M XK5000DA128ML	146	M16	GTO	75.0	26.0	190 125	WC40
XK7000DA128M XK7000DA128ML	146	M16	Diode / Thyristor	75.0	26.6	190 125	WC41
XK3060DA140ML XK3060SA140ML	154	M12	Press-Pack IGBTs	85.1	26.0	125	WC43 WC42
XK9000SA160M XK9000SA160ML	180	M16	Thyristor	99.3	35.8	190 125	WC44
XK9000DA160M XK9000DA160ML	180	M16	Thyristor	99.3	35.8	190 125	WC45
XK6120DA180ML XK6120SA180ML	196	M16	Press-Pack IGBTs	125.0	26.0	125	WC46 WC47

\* For new replacement part see page 150

Outline drawings are available from pages O-01...O-29

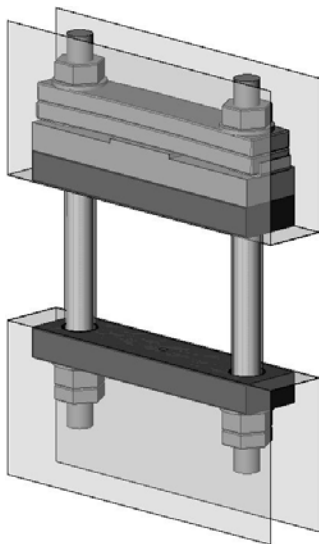

WC 18

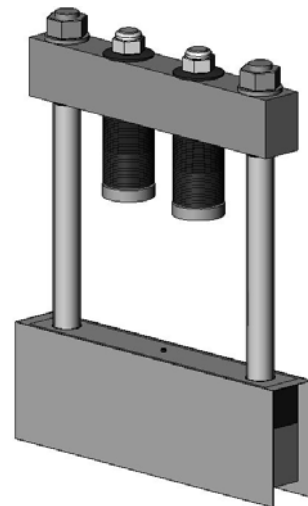

WC 45

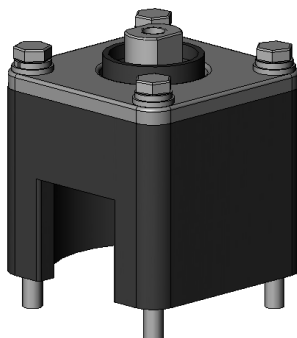

WC 50

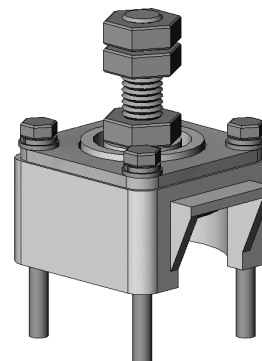

WC 48/49

# Bar Clamps - new range!

Range	Part number	### = Force kgf	Max cell dia mm	T <sub>JMAX</sub> °C	xxx = max Z - dim range mm	Outline
<b>XSK042</b>	XSK####DA042Mxxx	0500/0900	42	190	025-076*	WC58
	XSK####DT042Mxxx	0500/0900	42	190	025-076*	WC59
	XSK####DF042Mxxx	0500/0900	42	190	025-076*	WC60
<b>XSK054</b>	XSK####DA054Mxxx	0900	54	190	025-076*	WC58
	XSK####DT054Mxxx	0900	54	190	025-076*	WC59
	XSK####DF054Mxxx	0900	54	190	025-076*	WC60
<b>XSK056</b>	XSK####DA056Mxxx	0500/0900/1500	56	190	038-120*	WC58
	XSK####DT056Mxxx	0500/0900/1500	56	190	038-120*	WC59
	XSK####DF056Mxxx	0500/0900/1500	56	190	038-120*	WC60
<b>XSK065</b>	XSK####DA065Mxxx	0500/0900/1500	65	190	038-120*	WC58
	XSK####DT065Mxxx	0500/0900/1500	65	190	038-120*	WC59
	XSK####DF065Mxxx	0500/0900/1500	65	190	038-120*	WC60
<b>XSK075</b>	XSK####DA075Mxxx	0900/1500/2200	75	190	038-120*	WC58
	XSK####DT075Mxxx	0900/1500/2200	75	190	038-120*	WC59
	XSK####DF075Mxxx	0900/1500/2200	75	190	038-120*	WC60
<b>XSK087</b>	XSK####DA087Mxxx	1500/2200/3000	87	190	038-120*	WC61
	XSK####DT087Mxxx	1500/2200/3000	87	190	038-120*	WC62
	XSK####DF087Mxxx	1500/2200/3000	87	190	038-120*	WC63
<b>XSK103</b>	XSK####DA103Mxxx	2200/3200/4000	103	190	038-120*	WC61
	XSK####DF103Mxxx	2200/3200/4000	103	190	038-120*	WC63
<b>XSK112</b>	XSK####DA112Mxxx	2800/3200/3800/4500	112	190	038-120*	WC61
	XSK####DF112Mxxx	2800/3200/3800/4500	112	190	038-120*	WC63
<b>XSK120</b>	XSK####DA120Mxxx	3800/4500/5000	120	190	050-120*	WC61
	XSK####DF120Mxxx	3800/4500/5000	120	190	050-120*	WC63
<b>XSK126</b>	XSK####DA126Mxxx	3800/4500/5000	126	190	050-120*	WC61
	XSK####DF126Mxxx	3800/4500/5000	126	190	050-120*	WC63

\* contact factory for available sizes



WC 58



WC 59



WC 60



WC 61



WC 62



WC 63

Outline drawings  
on O-01...O-29

Range	A	A1	B	C	C1	D	E	F	G	H	Fixing
<b>XSK042</b>	69.85	74.89	54.00	15.88	21.04	42.00	8.64	PCF	PCF	12.70	M6
<b>XSK054</b>	82.55	86.04	65.00	15.88	21.04	54.00	8.62	34.93	PCF	12.70	M6
<b>XSK056</b>	95.25	-	70.00	25.40	-	56.00	12.19	PCF	PCF	9.53	M8
<b>XSK065</b>	104.39	-	79.00	25.40	-	65.00	12.19	PCF	PCF	12.70	M8
<b>XSK075</b>	112.78	-	89.00	25.40	-	75.00	12.19	PCF	PCF	12.70	M8
<b>XSK087</b>	127.00	-	102.00	25.40	-	87.00	12.19	PCF	PCF	19.05	M8
<b>XSK103</b>	144.78	154.11	118.00	25.40	36.00	103.00	PCF	PCF	PCF	19.05	M8
<b>XSK112</b>	165.02	-	132.00	25.40	36.00	112.00	16.56	PCF	PCF	25.40	M10
<b>XSK120</b>	172.72	-	140.00	25.40	36.00	120.00	16.56	PCF	PCF	25.40	M10
<b>XSK126</b>	181.10	-	146.00	25.40	36.00	126.00	16.56	PCF	PCF	25.40	M10

PCF = Dimension is dependent on clamp force and cell height. Please consult factory

All dimensions above in mm and relate to outline drawing notation

## Bar Clamps for WESPACK™ and GTO range

Part number	Rod Size & Length mm	Insulator Size & Length mm	Fixing centres	Pole Face	Clamp Forces	„Z“ mm	„D“ mm	Fig. No.
XSK1500DA076038	M8 x 90	M8 x 60	89	32	10kN to 20kN	38	27.5	WC51
XSK1500DA076076	M8 x 130	M8 x 95				76	62.5	
XSK1500DA076101	M8 x 160	M8 x 120				101	87.6	
XSK2000DA076038	M8 x 95	M8 x 60	89	38	13kN to 20kN	38	25.9	WC52
XSK2000DA076076	M8 x 130	M8 x 95				76	61.0	
XSK2000DA076101	M8 x 160	M8 x 120				101	85.9	
XSK3000DA076038	M8 x 100	M8 x 65	89	50	27kN to 34kN	38	26.2	WC53
XSK3000DA076076	M8 x 130	M8 x 100				76	56.1	
XSK3000DA076101	M8 x 160	M8 x 125				101	86.1	
XSK3400DA076038	M8 x 100	M8 x 65	89	50	25kN to 31kN	38	24.6	WC54
XSK3400DA076076	M8 x 140	M8 x 105				76	64.5	
XSK3400DA076101	M8 x 160	M8 x 130				101	89.7	
XSK3800DA116M076	M10 x 150	M12 x 100	132	66	32kN to 38kN	76	59.7	WC55
XSK3800DA116M101	M10 x 180	M12 x 125				101	84.6	
XSK4400DA116M076	M10 x 150	M12 x 105	132	68	36kN to 44kN	76	63.0	WC56
XSK4400DA116M101	M10 x 180	M12 x 130				101	87.9	
XSK6000DA116M076	M10 x 150	M12 x 105	132	75	50kN to 60kN	76	59.9	WC57
XSK6000DA116M101	M10 x 180	M12 x 130				101	84.8	

Note: 1 Kgf = 9.8 Newtons

T<sub>JMAX</sub> = 190°C

Outline drawings are available from pages O-01...O-29



WC51

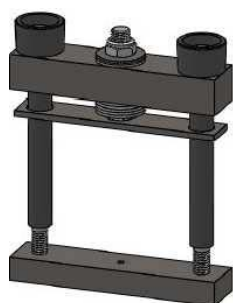

WC52



WC53

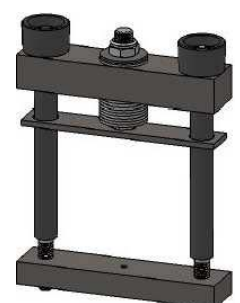

WC54

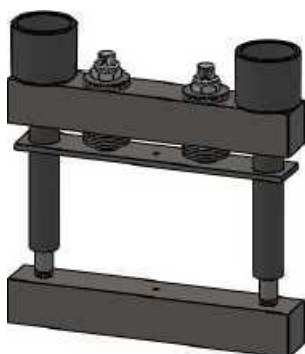

WC55

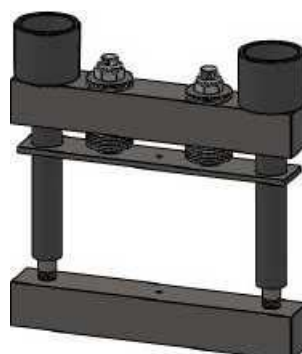

WC56

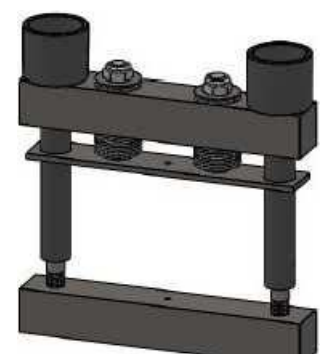

WC57

# Box Clamps

Part Number	Moulded Box Style	Fixing Centres mm	Rod Size	Capsule Device			Outline Ref.
				Outline	Mounting Surface Ø mm	Nominal Thickness mm	
XK0450BA019M XK0450BB019M	Injection Compression	50 PCD	M5x50 Bolts	DO-200AA/TO-200AB	19.0	13.8	WC48
XK0450BA025M XK0450BB025M	Injection Compression	50 PCD	M5x50 Bolts	DO-200AA/TO-200AB	25.1	14.6	WC49
XK1500BA034M	Injection	70 PCD	M6x50 Bolts	DO-200AB/TO-200AC	34.0	26.2	WC50

Note: 1 Kgf = 9.8 Newtons

WC 48/49

WC 50

Outline drawings are available from pages O-01...O-29

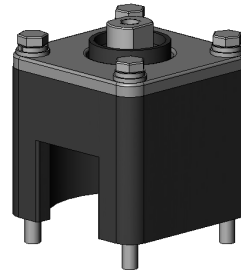
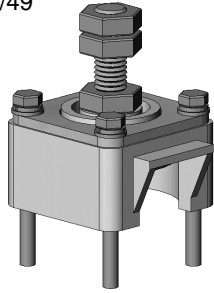

# Heatsinks

Part No.	Weight Kg/m	Periphery mm	Area mm <sup>2</sup>	Fig. No.
XSFGxxxxAN	8.1	1059	2979	WH1
XSFGAxxxxAN	15.6	1682	5867	WH2
XSFHxxxxAN	12.7	1684	4655	WH3
XSFTxxxxAN	20	2065	7573	WH4
XSFTBxxxxAN	29	2467	10905	WH5
XSFTCxxxxAN	28	2544	10561	WH6
SXFLPxxxxAN	30	6620	11172	WH7
SXF46xxxxAN	20	2822	7411	WH8
SXF30xxxxAN	Dimensions 125mm x 125mm x 4 vanes			WH9

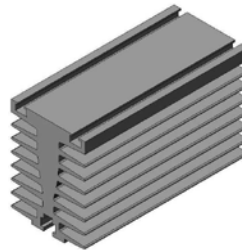

WH1

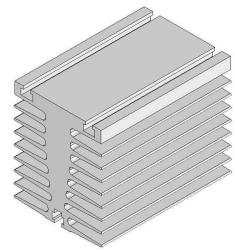

WH2

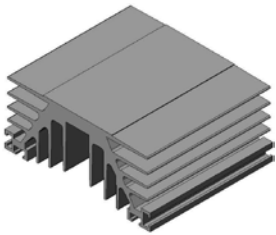

WH3

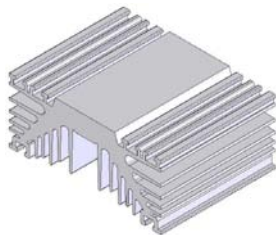

WH4

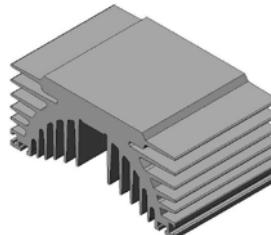

WH5

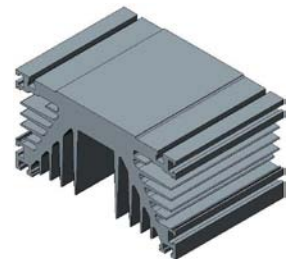

WH6

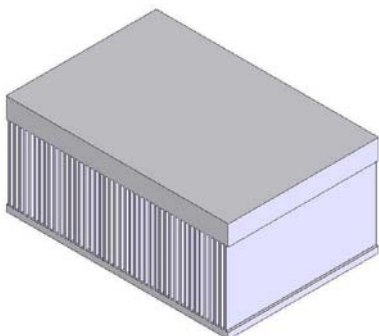

WH7

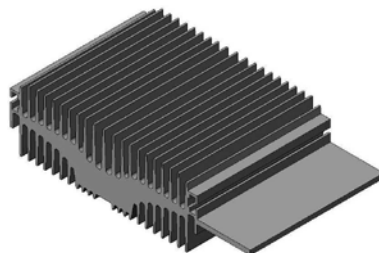

WH8

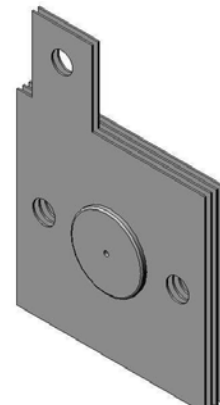

WH9

# Coolers

Part Number	Weight	Cooler Thickness	Busbar Thickness	Description	Fig. No.
New	Kg	mm	mm		
XW076NC16A	0.418	16	N/A	47mm WC Cu	WCL2
XW076NC16B				47mm WC Cu with Busbar (10mm Hose)	WCL1
XW076NC16BS				47mm WC Cu with Busbar + spirol pins fitted (10mm Hose)	WCL1
XW076NC16BT	0.612	16	6.4	47mm WC Cu with Busbar + thermostat hole (10mm Hose)	WCL1
XW076NC16C				47mm WC Cu with Busbar (1/2" Hose)	WCL1
XW076NC16CT				47mm WC Cu with Busbar + thermostat hole (1/2" Hose)	WCL1
XW076NC16R	0.581	16	6.35	47mm WC Cu reversed with Busbar	WCL12
XW076NC16W	0.400	16	N/A	47mm WC Cu reversed	WCL13
XW116ZC20A	1.300	20	N/A	73mm WC Cu	WCL4
XW116ZC20B	1.750	20	10	73mm WC Cu with Busbar	WCL3
XW116ZC20C	2.120	20	10	73mm WC Cu with alt. Busbar	WCL5
XW116ZC20R	1.672	20	10	73mm WC Cu reversed with Busbar	WCL14
XW116ZC20W	1.119	20	N/A	73mm WC Cu reversed	WCL15
XW127EN15A				85mm WC Al Nitride	WCL8
XW127EN15B	0.375	15	N/A	85mm WC Al Nitride without holes	WCL8
XW127EC25A	1.650	25	N/A	85mm WC Cu Helix	WCL16
XW127EC25B	2.200	25	8	85mm WC Cu with Busbar Helix	WCL17
XW127EA25A	0.500	25	N/A	85mm WC Al Helix	WCL16
XW127EA25B	0.650	25	8	85mm WC Al with Busbar Helix	WCL17
XW160FC25A	3.620	25	N/A	100mm WC Cu	WCL6
XW160FC25B	4.520	25	10	100mm WC Cu with Busbar	WCL7
XW180GC34A	4.920	34	N/A	125mm WC Cu Helix	WCL11
XW180GC34B	5.950	34	10	125mm WC Cu with Busbar Helix	WCL10
XW180GA34A	1.500	34	N/A	125mm WC Al Helix	WCL11
XW180GA34B	1.800	34	10	125mm WC Al with Busbar Helix	WCL10
XW180GN25A	0.920	25	N/A	125mm WC Al Nitride Helix	WCL18
XW270QA25A	2.941	25	n/a	270 x 190mm WC Al Cold Plate	WCL9

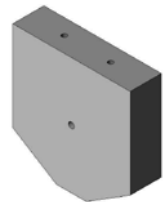

WCL2

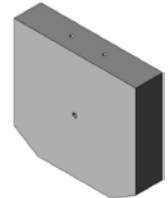

WCL4

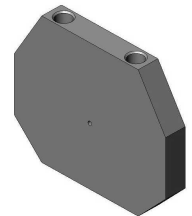

WCL8

Outlines on pages O-01...O-29

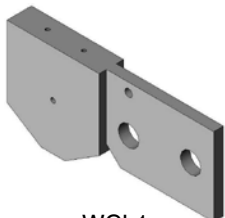

WCL1

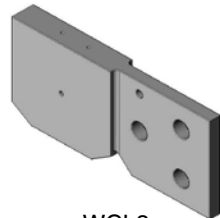

WCL3

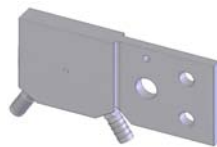

WCL5

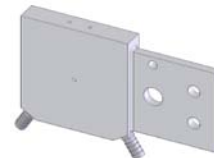

WCL6



WCL7

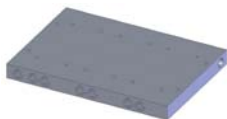

WCL9 -WS65

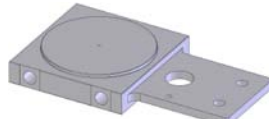

WCL10



WCL11

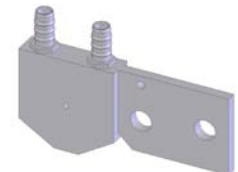

WCL12 -WS71-1

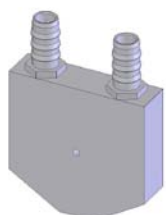

WCL13 -WS71-2

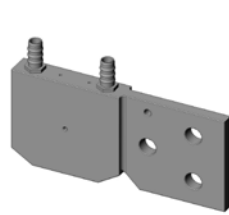

WCL14 -WS72-1

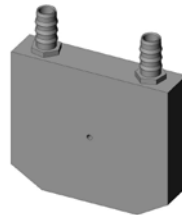

WCL15 -WS72-2

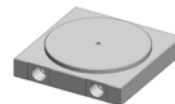

WCL16

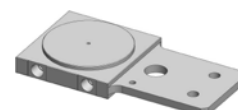

WCL17

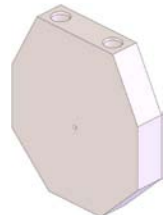

WCL18

Part No.	Cooler Accessories
XSNM12H10S	M12 Cooler Connection, 10mm Hose & Stainless Steel material
XSNM12H12S	M12 Cooler Connection, 12mm Hose & Stainless Steel material
XSNM10H15P	M10 Cooler Connection, 15mm Hose & Plastic Material

# Snubber Capacitors - New Range

A new addition for 2013, IXYS UK's new range of snubber capacitors. These capacitors have a low series resistance, high pulse strength and low self-inductance of 15nH; they also have very good self-healing characteristics without loss of capacitance. These capacitors consist of a flame retardent plastic can filled with solid resin to ensure reliable operation even under the most extreme environmental conditions.

Part No.	Capacitance CN  μF	Series Resistance ESR  mΩ	RMS Current $I_{RMS}$  A	Peak Current $I_{PK}$  kA	Peak Surge Current $I_s$  kA	DC Voltage $V_{DC}$  V	AC Voltage $V_{AC}$  V	Non-repetitive Surge voltage $V_s$  V	Fig.	Dia- meter D1  mm	Length L1  mm
E53.H59-471T1W	0.47	2.90	20	0.70	2.10	3750	2100	5625	T1	55	59
E53.H59-102T1W	1.00	1.60	40	0.35	1.75	3200	1050	4800	T1	55	59
E53.H59-152T1W	1.50	2.40	32	0.27	1.35	2800	700	4200	T1	55	59
E53.H59-252T1W	2.50	1.80	40	0.37	1.10	2250	700	3375	T1	55	59
E53.M59-252T2W	2.50	0.65	75	0.90	4.50	3200	1050	4800	T2	75	59
E53.R11-302T2W	3.00	1.20	125	2.10	6.30	5000	2100	7500	T1	115	110
E53.H59-332T1W	3.30	1.60	40	0.42	1.20	2000	700	3000	T1	55	59
E53.M59-332T2W	3.30	1.10	60	0.60	3.00	2800	700	4200	T2	75	59
E53.P59-402T2W	4.00	0.50	80	1.50	7.50	3200	1050	4800	T2	95	59
E53.R11-402T2W	4.00	1.00	125	2.50	7.50	5000	2100	7500	T2	115	110
E53.H59-472T1W	4.70	1.10	45	0.50	1.60	1700	700	2550	T1	55	59
E53.Q59-502T2W	5.00	0.32	100	1.80	9.00	3200	1050	4800	T2	105	59
E53.M59-602T2W	6.00	0.75	70	0.88	2.60	2250	700	3375	T2	75	59
E53.Q59-602T2W	6.00	0.28	100	2.20	11.00	3200	1050	4800	T2	105	59
E53.P59-682T2W	6.80	0.55	80	1.20	6.00	2800	700	4200	T2	95	59
E53.R60-702T2W	7.00	0.25	100	3.00	12.00	3200	1050	4800	T2	115	60
E53.P59-752T2W	7.50	0.50	80	1.50	7.50	2800	700	4200	T2	95	59
E53.H59-802T1W	8.00	1.70	38	0.33	1.00	1400	350	2100	T1	55	59
E53.M59-802T2W	8.00	0.65	80	1.00	3.00	2000	700	3000	T2	75	59
E53.Q59-802T2W	8.00	0.45	100	1.50	7.50	2800	700	4200	T2	105	59
E53.M59-103T2W	10.00	0.52	80	1.10	3.50	1700	700	2550	T2	75	59
E53.P59-103T2W	10.00	0.46	80	1.50	4.50	2250	700	3375	T2	95	59
E53.Q59-103T2W	10.00	0.35	100	1.80	9.00	2800	700	4200	T2	105	59
E53.H59-123T1W	12.00	1.70	40	0.40	1.20	1100	350	1650	T1	55	59
E53.R60-123T2W	12.00	0.29	100	2.20	12.00	2800	700	4200	T2	115	60
E53.P59-143T2W	14.00	0.35	80	1.80	5.50	2000	700	3000	T2	95	59
E53.Q59-143T2W	14.00	0.33	100	2.00	6.00	2250	700	3375	T2	105	59
E53.H59-153T1W	15.00	1.10	40	0.50	1.50	1100	350	1650	T1	55	59
E53.Q59-153T2W	15.00	0.27	100	2.10	6.20	2250	700	3375	T2	105	59
E53.M59-163T2W	16.00	0.85	60	0.65	1.35	1400	350	2100	T2	75	59
E53.P59-163T2W	16.00	0.37	80	1.80	5.50	1700	700	2550	T2	95	59
E53.Q59-183T2W	18.00	0.26	100	2.30	6.90	2000	700	3000	T2	105	59
E53.R60-183T2W	18.00	0.25	100	2.60	10.00	2250	700	3375	T2	115	60
E53.Q59-223T2W	22.00	0.27	100	2.50	7.50	1700	700	2550	T2	105	59
E53.R60-243T2W	24.00	0.21	100	3.00	10.00	2000	700	3000	T2	115	60
E53.M59-253T2W	25.00	0.71	70	0.83	2.50	1100	350	1650	T2	75	59
E53.H59-303T1W	30.00	0.85	60	0.68	2.10	900	350	1350	T1	55	59
E53.N51-303H1W	30.00	1.30	60	1.30	3.90	1600	-	2400	H1	85	51
E53.P59-303T2W	30.00	0.46	80	1.20	3.70	1400	350	2100	T2	95	59
E53.H59-333T1W	33.00	0.95	55	0.68	2.10	700	350	1050	T1	55	59
E53.R60-333T2W	33.00	0.18	100	3.50	10.00	1700	700	2550	T2	115	60
E53.N51-383H1W	37.50	1.20	60	1.40	4.00	1400	-	2100	H1	85	51
E53.N68-403H1W	40.00	1.60	60	1.30	3.90	1600	-	2400	H1	85	68
E53.Q59-403T2W	40.00	0.34	100	1.70	5.10	1400	350	2100	T2	105	59
E53.H59-503T1W	50.00	0.80	60	0.83	2.50	550	280	825	T1	55	59
E53.N51-503H1W	50.00	1.10	70	1.60	4.80	1200	-	1800	H1	85	51
E53.N68-503H1W	50.00	1.50	60	1.40	4.20	1400	-	2100	H1	85	68
E53.P59-503T2W	50.00	0.34	80	1.70	5.00	1100	350	1650	T2	95	59
E53.R60-503T2W	50.00	0.27	100	2.20	10.00	1400	350	2100	T2	115	60

H1



T1/T2





# Standard base clamp kits for rectifier diodes and phase control thyristors

These Single side cooled square base mounting clamps are suitable for 34 mm to 50 mm pole face devices with clamping force in the range from 1130 Kgf to 2140 Kgf. Suitable for devices with blocking voltages from 400 volts up to 6 KV.

Part No.	Poleface Ref.	Outline Ref.
<b>XK1500CB034M †</b>	34-38	WC64
<b>XK1130SB076M</b>	34-38	WC65
<b>XK2140SB076M</b>	47-50	WC66

Standard part replacements to the obsolete flat-base power silicon diodes types KBN/R, KCN/R & KDN/R. For other voltages and thyristor options please consult factory.

Part No.	Old square base part no.	Base polarity	$V_{RRM}$ V	$I_{Iav}$ $T_C = 100^\circ C$ A	$I_{RSM}$ kA	$I^2t$ A <sup>2</sup> s	$V_0$ V	$r_T$ mΩ	$R_{th}$ K/W	Temp °C	Outline
W1185LC450KBR †	SW45KBR515	Anode	4500	435	10.2	520 x 10 <sup>3</sup>	1.000	0.575	0.085	160	WC64
W1185LC450KBN †	SW45KBN515	Cathode	4500	380	10.2	520 x 10 <sup>3</sup>	1.000	0.575	0.101	160	WC64
W1411LC360KBR †	SW36KBR595	Anode	3600	505	12.2	744 x 10 <sup>3</sup>	0.900	0.388	0.085	160	WC64
W1411LC360KBN †	SW36KBN595	Cathode	3600	445	12.2	744 x 10 <sup>3</sup>	0.900	0.388	0.101	160	WC64
W1524LC300KBR †	SW30KBR636	Anode	3000	540	13.4	898 x 10 <sup>3</sup>	0.870	0.323	0.085	160	WC64
W1524LC300KBN †	SW30KBN636	Cathode	3000	470	13.4	898 x 10 <sup>3</sup>	0.870	0.323	0.101	160	WC64
W1748LC220KBR †	SW22KBR805	Anode	2200	660	13.5	911 x 10 <sup>3</sup>	0.870	0.280	0.085	175	WC64
W1748LC220KBN †	SW22KBN805	Cathode	2200	582	13.5	911 x 10 <sup>3</sup>	0.870	0.280	0.101	175	WC64
W2058LC120KBR †	SW12KBR935	Anode	1200	760	16.1	1.30 x 10 <sup>6</sup>	0.790	0.192	0.085	175	WC64
W2058LC120KBN †	SW12KBN935	Cathode	1200	665	16.1	1.30 x 10 <sup>6</sup>	0.790	0.192	0.101	175	WC64
W1185LC450KCR	SW38KBR515	Anode	4500	455	10.2	520 x 10 <sup>3</sup>	1.000	0.575	0.080	160	WC65
W1185LC450KCN	SW45KBN515	Cathode	4500	395	10.2	520 x 10 <sup>3</sup>	1.000	0.575	0.097	160	WC65
W1411LC360KCR	SW36KBR595	Anode	3600	530	13.2	756 x 10 <sup>3</sup>	0.900	0.388	0.080	160	WC65
W1411LC360KCN	SW36KBN595	Cathode	3600	460	12.3	759 x 10 <sup>3</sup>	0.900	0.388	0.097	160	WC65
W1524LC300KCR	SW30KBR635	Anode	3000	565	13.4	898 x 10 <sup>3</sup>	0.870	0.323	0.080	160	WC65
W1524LC300KCN	SW30KBN636	Cathode	3000	490	13.4	898 x 10 <sup>3</sup>	0.870	0.323	0.097	160	WC65
W1748LC220KCR	SW22KBR805	Anode	2200	690	13.5	911 x 10 <sup>3</sup>	0.870	0.280	0.080	175	WC65
W1748LC220KCN	SW22KBN805	Cathode	2200	600	13.5	911 x 10 <sup>3</sup>	0.870	0.280	0.097	175	WC65
W2058LC120KCR	SW12KBR935	Anode	1200	800	16.1	1.30 x 10 <sup>6</sup>	0.790	0.192	0.080	175	WC65
W2058LC120KCN	SW12KBN935	Cathode	1200	690	16.1	1.30 x 10 <sup>6</sup>	0.790	0.192	0.097	175	WC65
W3082MC45KDR	SB45KDR680	Anode	4500	1115	26.6	3.54 x 10 <sup>6</sup>	0.923	0.192	0.037	160	WC66
W3082MC45KDN	SB45KDN680	Cathode	4500	1030	26.6	3.54 x 10 <sup>6</sup>	0.923	0.192	0.041	160	WC66
W3708MC35KDR	SB35KDR820	Anode	3500	1240	33.7	5.68 x 10 <sup>6</sup>	0.958	0.112	0.037	160	WC66
W3708MC35KDN	SB35KDN820	Cathode	3500	1145	33.7	5.68 x 10 <sup>6</sup>	0.958	0.112	0.041	160	WC66
W3842MC28KDR	SB25KDR950	Anode	2800	1325	33.5	5.61 x 10 <sup>6</sup>	0.831	0.118	0.037	160	WC66
W3842MC28KDN	SB25KDN950	Cathode	2800	1225	33.5	5.61 x 10 <sup>6</sup>	0.831	0.118	0.041	160	WC66
W5636MC15KDR	SB15KDR14C	Anode	1500	2035	43.9	9.64 x 10 <sup>6</sup>	0.698	0.059	0.037	175	WC66
W5636MC15KDN	SB15KDN14C	Cathode	1500	1875	43.9	9.64 x 10 <sup>6</sup>	0.698	0.059	0.041	175	WC66

† - Assembly supplied either as kit of parts or sub-assembly with selected diode or thyristor

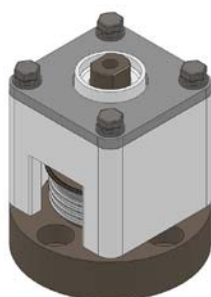

WC64

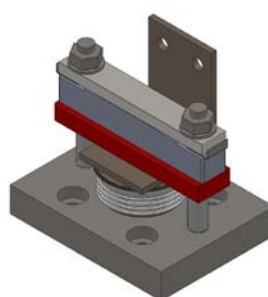

WC65

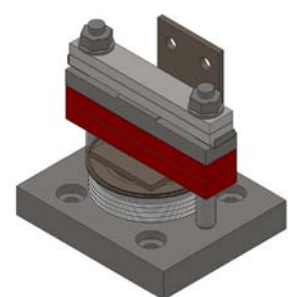

WC66

# Power Semiconductor Chips

IXYS offers a wide range of dice for a multitude of applications.

Bipolar Chips	$V_{RRM} / V_{DRM}$	$I_{F(AV)M} / I_{T(AV)M}$	$t_{rr}$
Schottky Diodes	8 - 200 V	5 - 300 A	-
HiPerFRED™ (Low Leakage)	200 - 1200 V	10 - 150 A	30 - 40 ns
Sonic™ Fast Recovery Diodes	600 - 1800 V	5 - 150 A	30 - 60 ns
FRED™ (Low Forward Voltage Drop)	200 - 1200 V	10 - 150 A	40 - 60 ns
Semi-Fast Diodes	1200 - 1600 V	15 - 60 A	60 - 100 ns
Rectifier Diodes	1200 - 2200 V	10 - 400 A	-
Phase Control Thyristors	800 - 2200 V	5 - 300 A	-

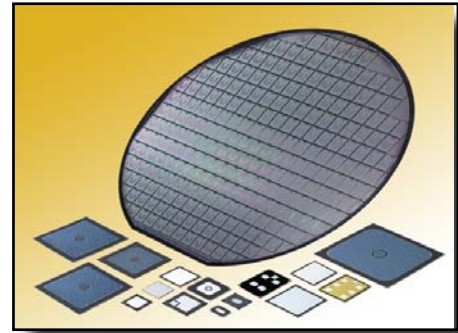

## The most important features of planar technology are:

- no PN junction termination in the underside or to the edges; thus non-critical handling and simplified mounting
- fabricated using isolation diffusion with guard rings, channel stoppers and thick glass passivation to assure high electrical reliability and stability
- important electrical parameters 100% tested on the chips
- thyristor chips with center or corner gate construction
- chips with solderable or bondable metallization
- standard 125 mm (5 inch) and 150 mm (6 inch) diameter wafers

## IXYS can ship chips as follows:

- Chips in wafer form, unsawn, electrically tested, rejects are inked
- Chips in sawed wafer on foil, electrically tested, rejects are inked
- Chips in tray (Waffle Pack), electrically tested

# Direct Copper Bonded Ceramic Substrates

## DCB Ceramic Substrates (Al<sub>2</sub>O<sub>3</sub>)

IXYS manufactures Direct Copper Bonded substrates on aluminum oxide (Al<sub>2</sub>O<sub>3</sub>) base.

DCB ceramic substrates form the basis for new product ideas and electronic developments with a high degree of integration.

Standard bonded DCB panel dimensions are:

Unclad aluminum oxide ceramic			
Al <sub>2</sub> O <sub>3</sub> content		> 96	%
dimensions		138x210, 138x190.5, 115x165*	mm
usable area	max.	130x200, 130x180, 107x156*	mm
thickness		1.00, 0.63, 0.38, 0.25	mm
arc through voltage		10	kV
thermal conductivity		> 24	W/m · K
Conduction layers - both sides			
copper thickness		0.3 (< 0.3 on request)	mm
conductor width	min.	0.3 +/- 0.2	mm
conductor spacing	min.	0.4 +/- 0.2	mm
spacing conductor/edge of ceramic	min.	0.35 +/- 0.2	mm
surface finishes available		bare copper; nickel plated; nickel + gold plated	
peel-off resistance (90° peel test)		>6	N/mm
DCB ceramic substrate			
application temperature range		-55...+850	°C
resistant to hydrogen	max. up	400	°C
thermal expansion coefficient	to typ.	7.4 x 10-6	K-1
customer specific dimensions			

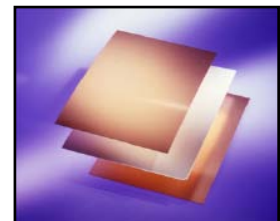

Patterned DCB substrates can be manufactured to customers' drawings.

## DCB ceramic substrates fulfill several functions:

- carriers for semiconductor chips and connection clips
- circuits similar to that on a PC board
- electrical isolator for separating „current paths“ from „heat paths“
- transfer medium for heat dissipation from active parts into heat sink

DCB parts are available as:

- bonded plate
- bonded and patterned plate
- prelasered, unbroken plate
- individuale substrates

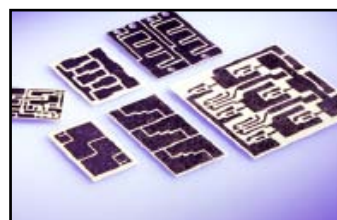

\* = (for 0.25 mm thk.)

Dimensions in mm and inches (1 mm = 0.0394")

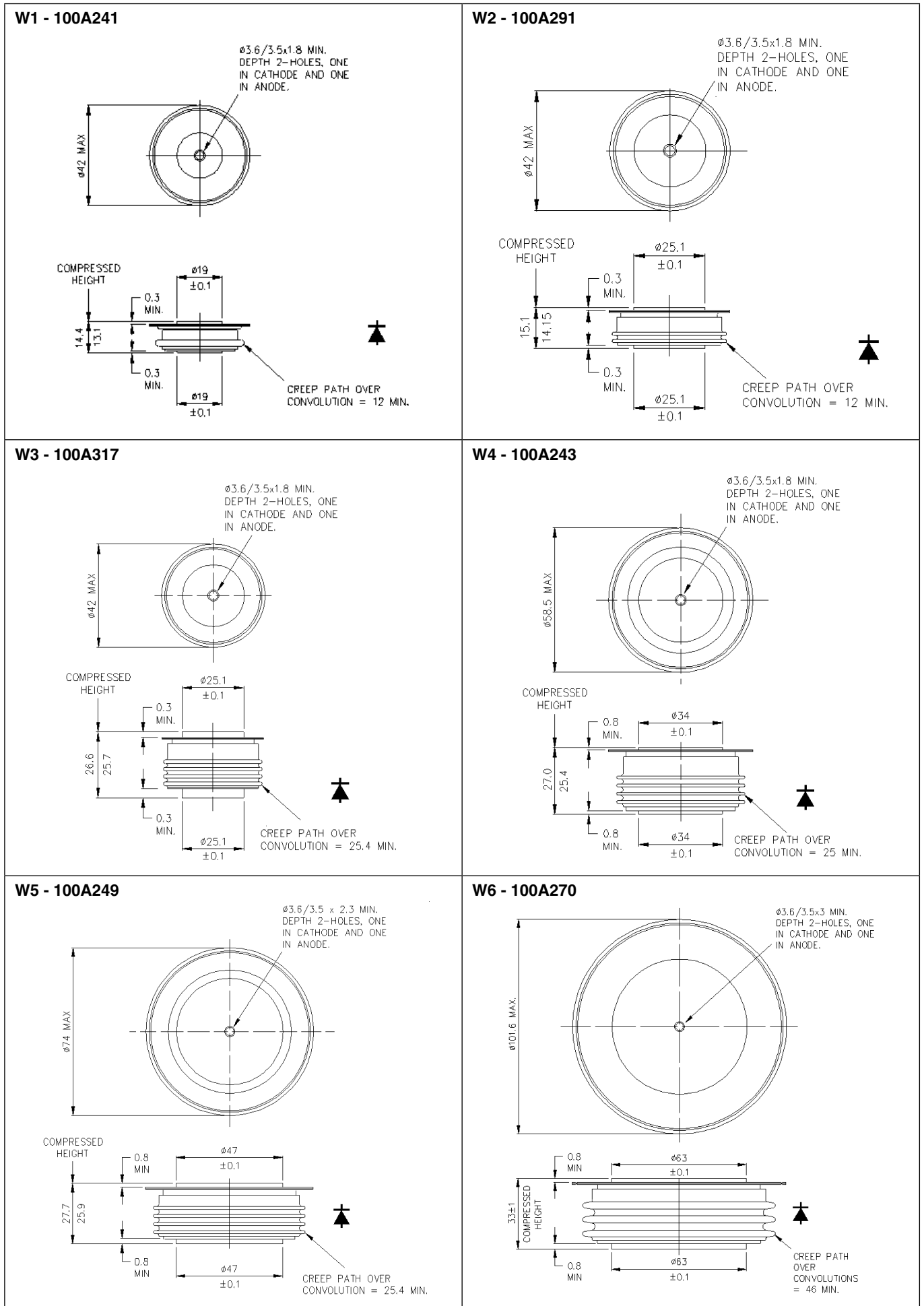

Dimensions in mm and inches (1 mm = 0.0394")

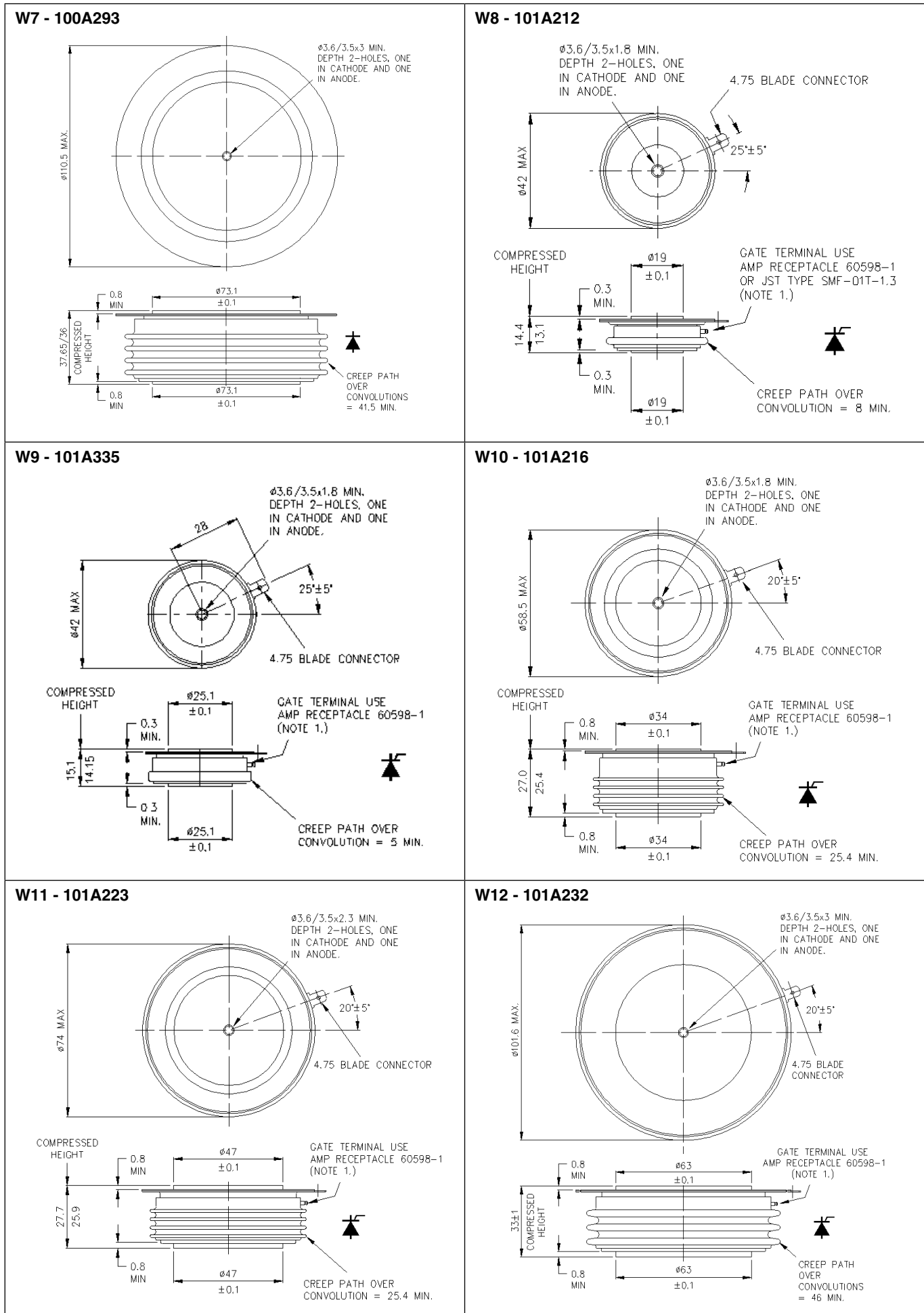

Dimensions in mm and inches (1 mm = 0.0394")

**W13 - 101A281**

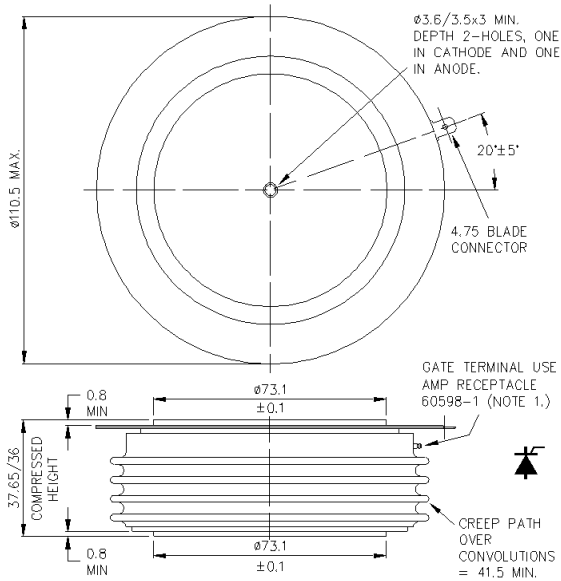

**W14 - 101A325**

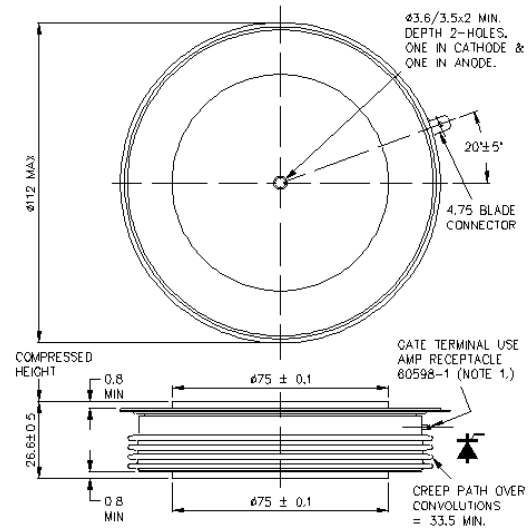

**W15 - 101A322**

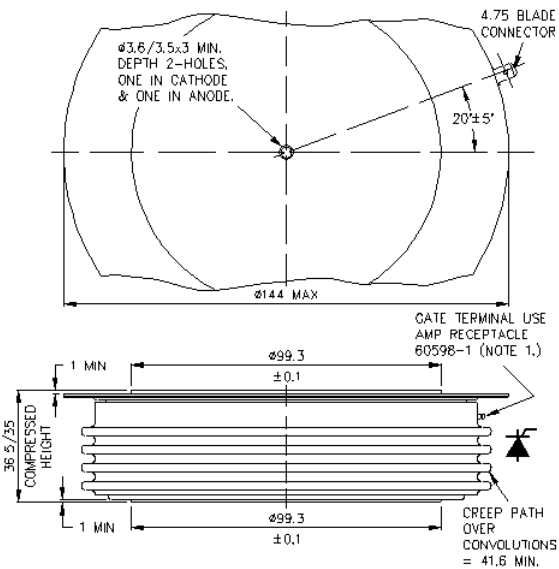

**W16 - 101A235**

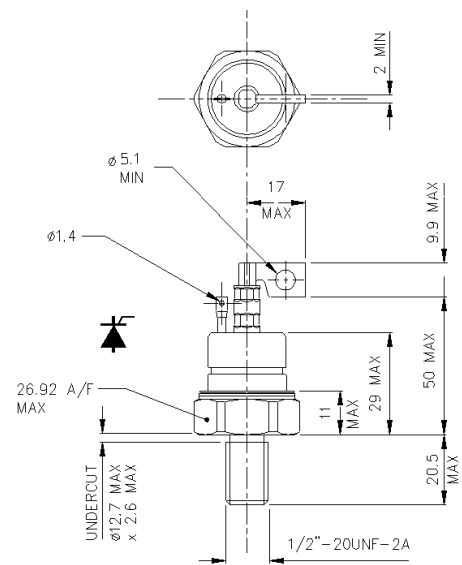

**W17 - 101A231**

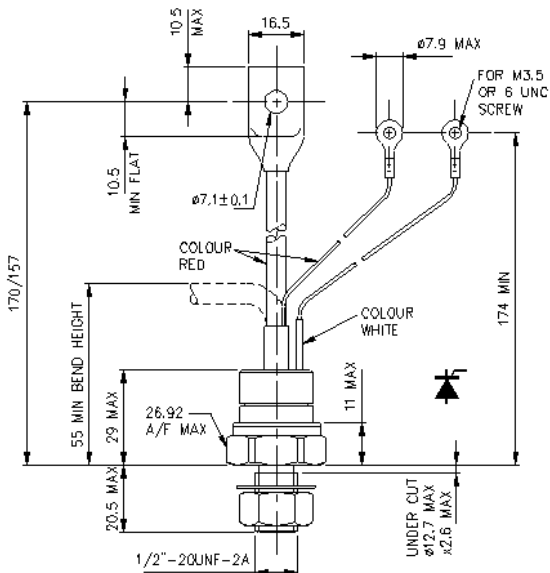

**W18 - 101A225**

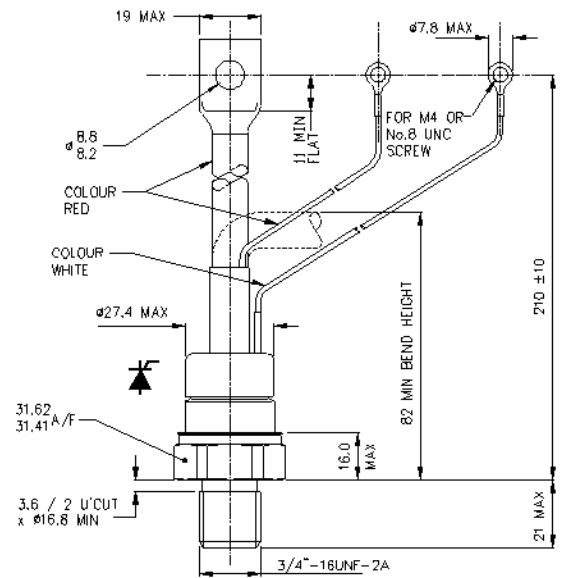

Dimensions in mm and inches (1 mm = 0.0394")

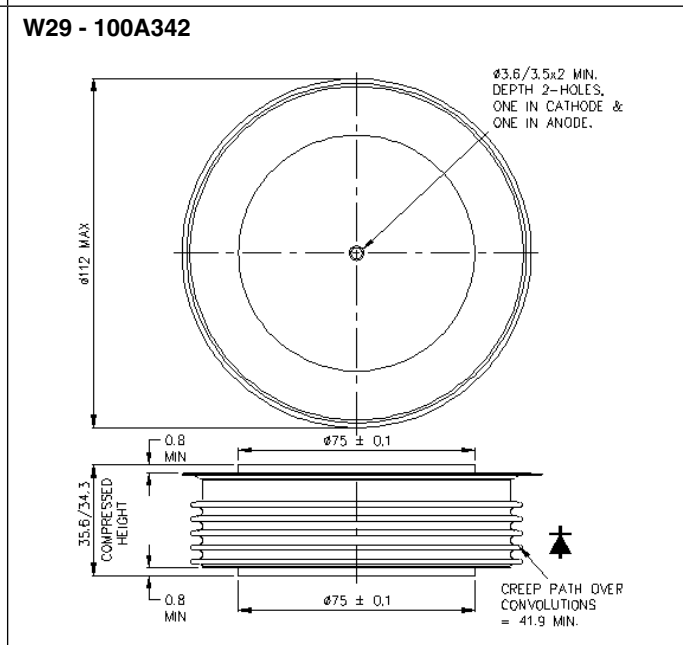
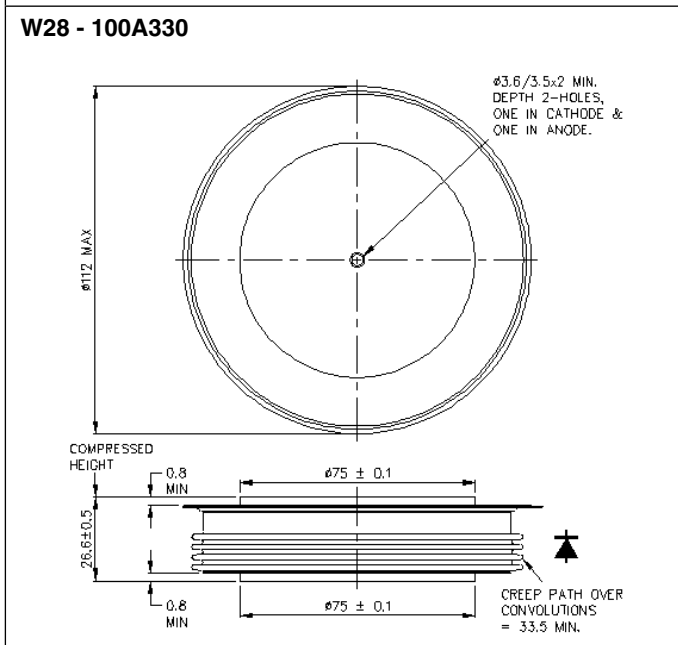
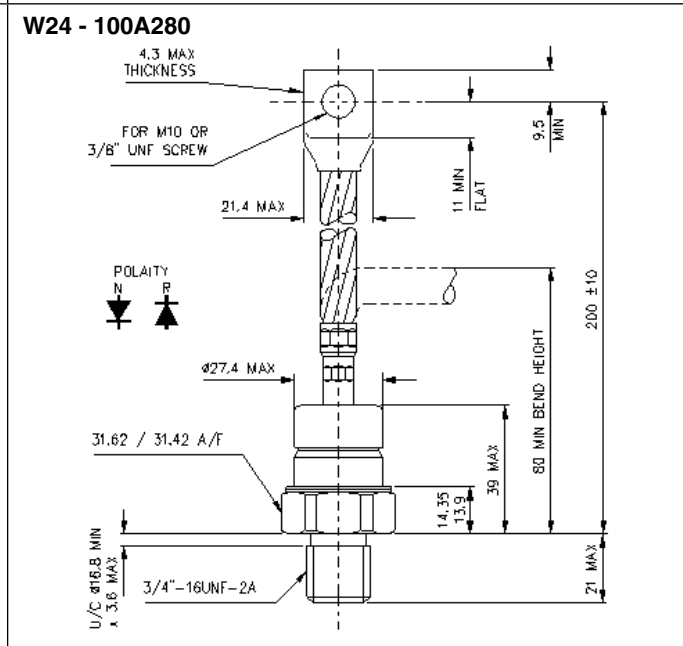
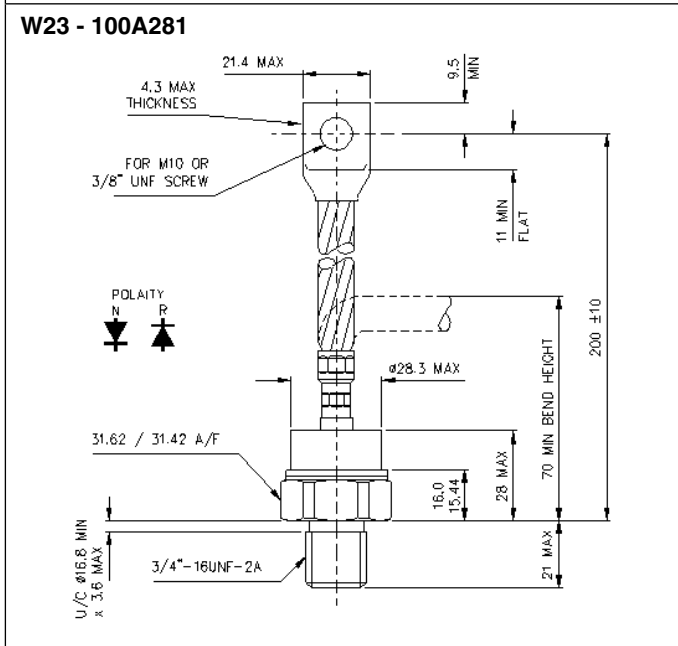
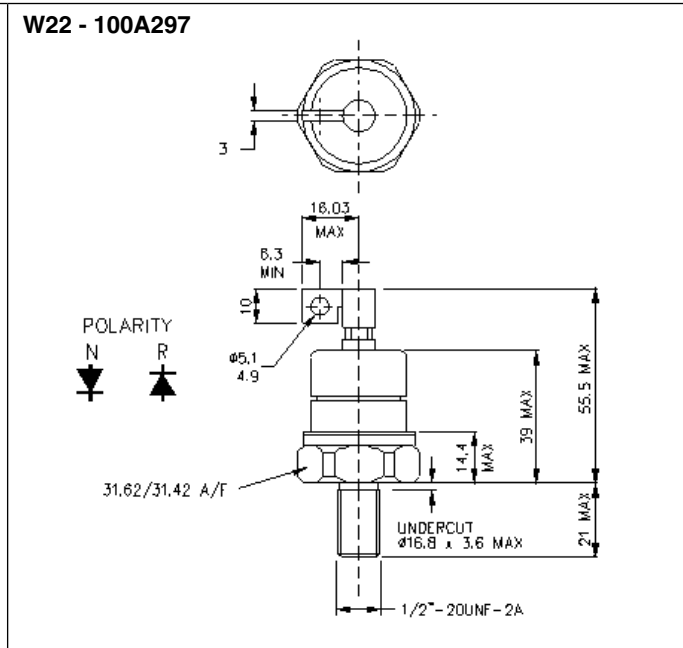
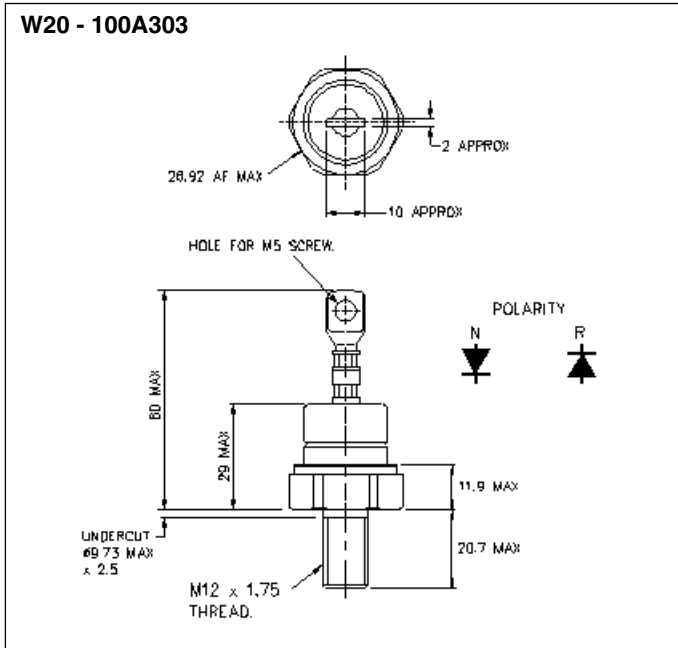

Dimensions in mm and inches (1 mm = 0.0394")

**W33 - 101A346**

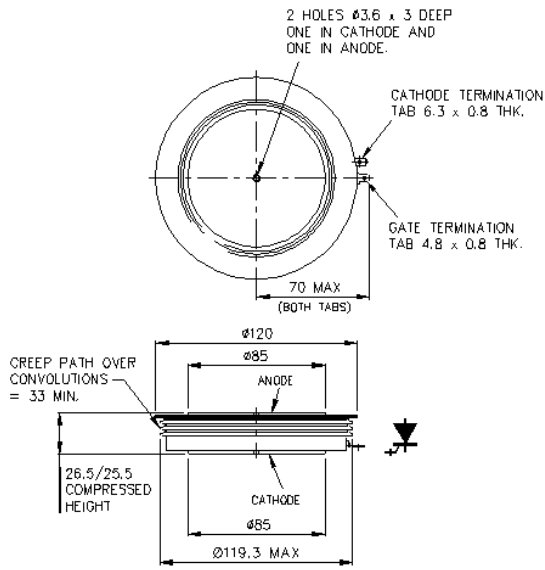

**W34 - 101A287**

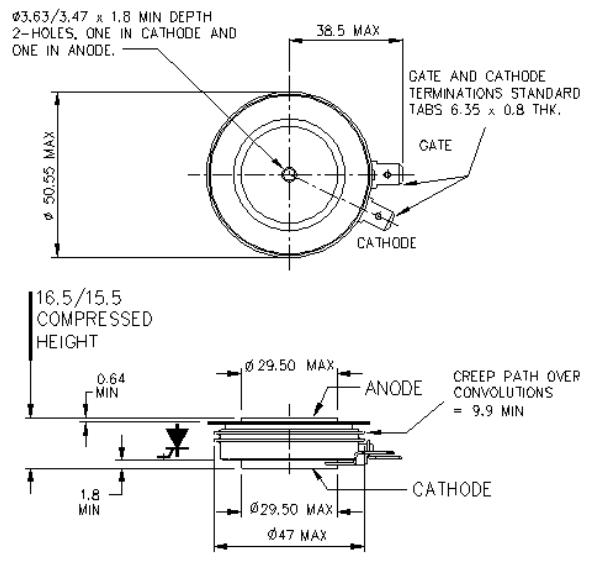

**W35 - 101A358**

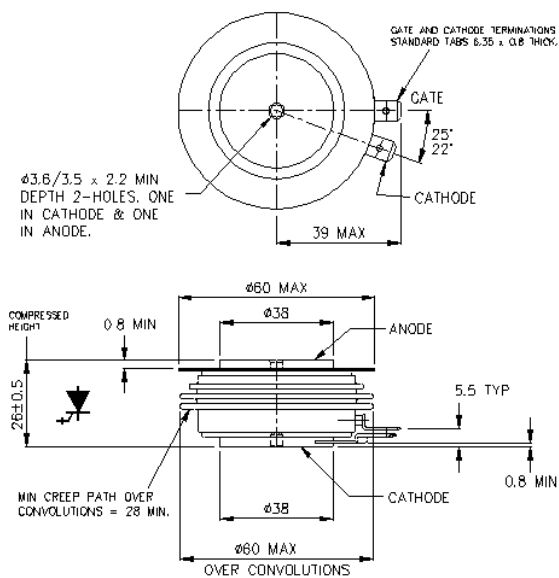

**W36 - 101A288**

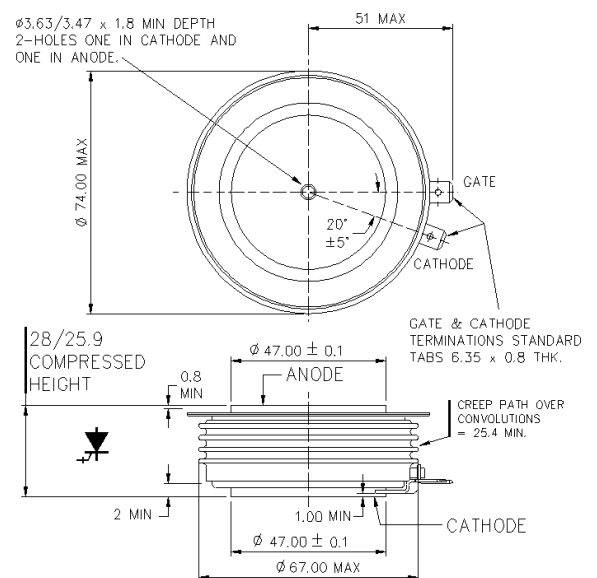

**W37 - 100A325**

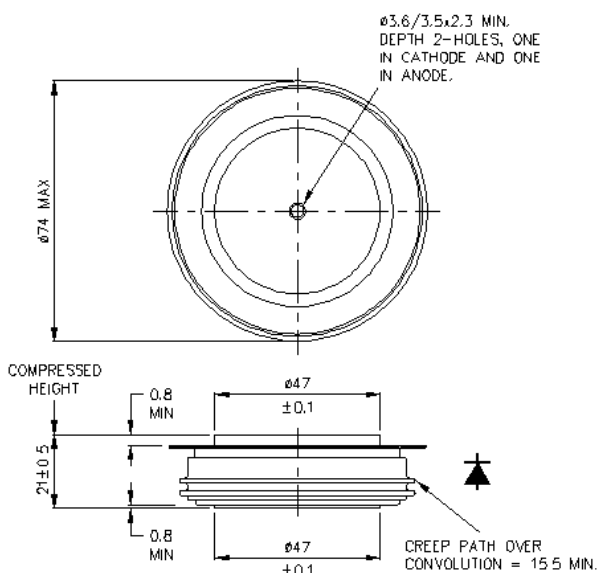

**W39 - 100A338**

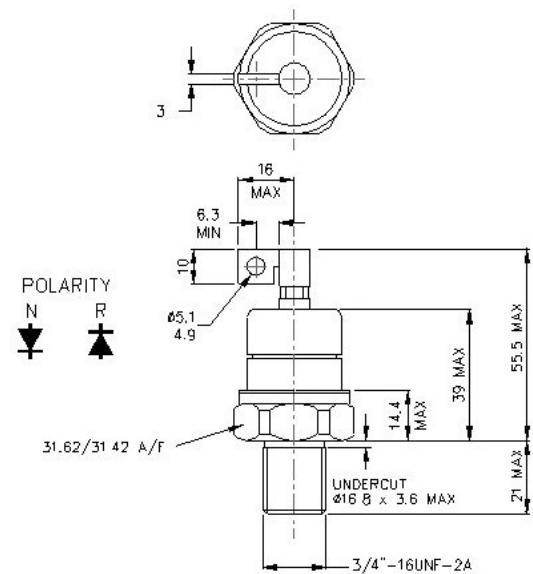

Dimensions in mm and inches (1 mm = 0.0394")

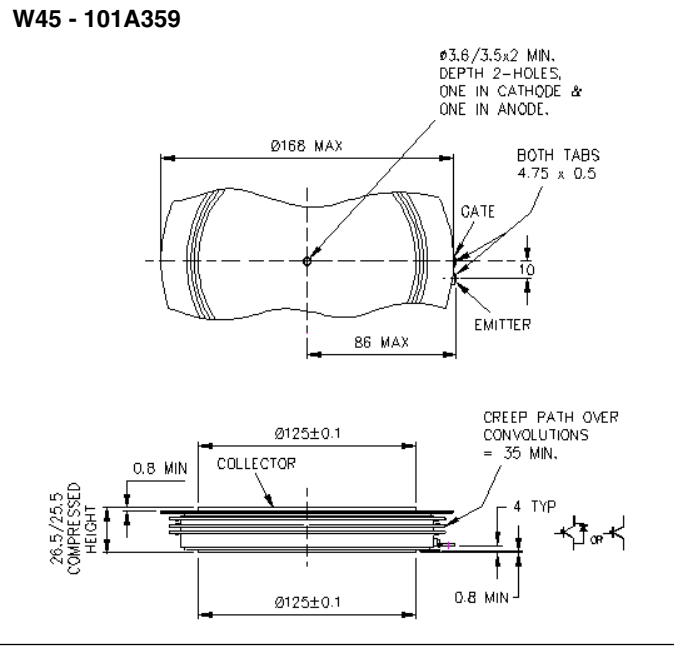
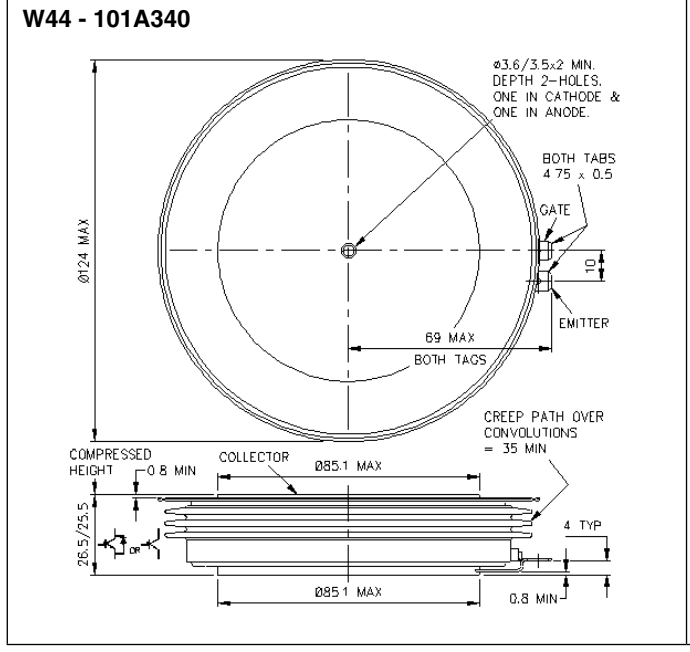
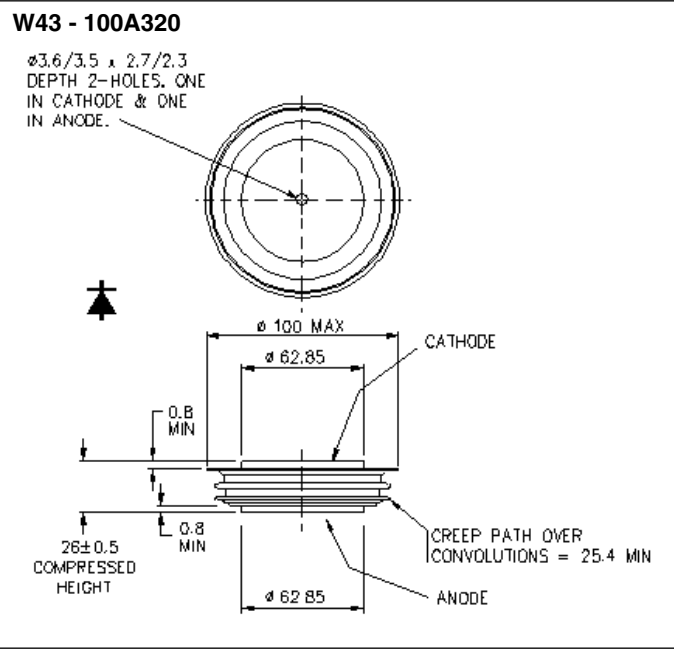
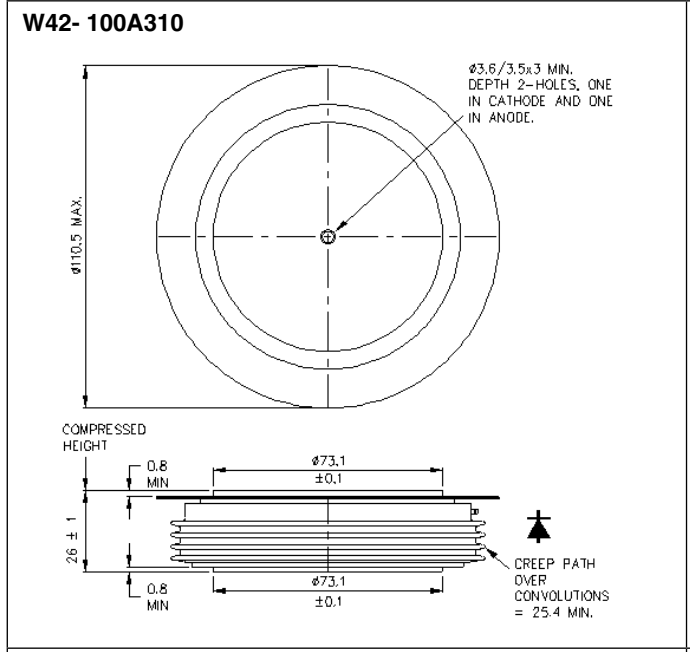
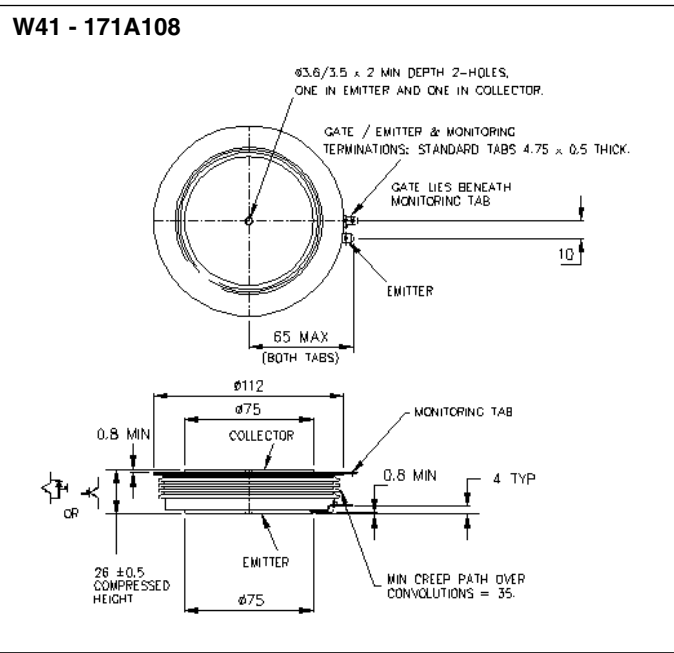
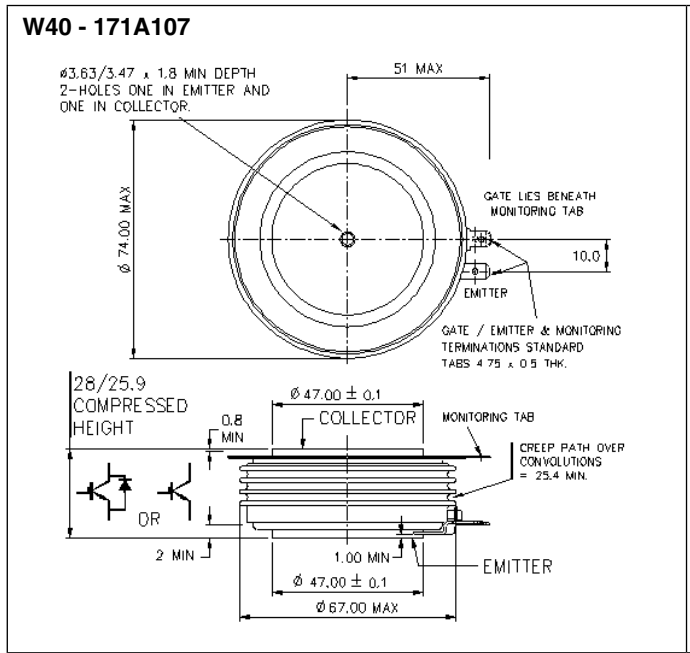



Dimensions in mm and inches (1 mm = 0.0394")

**W46 - 101A305**

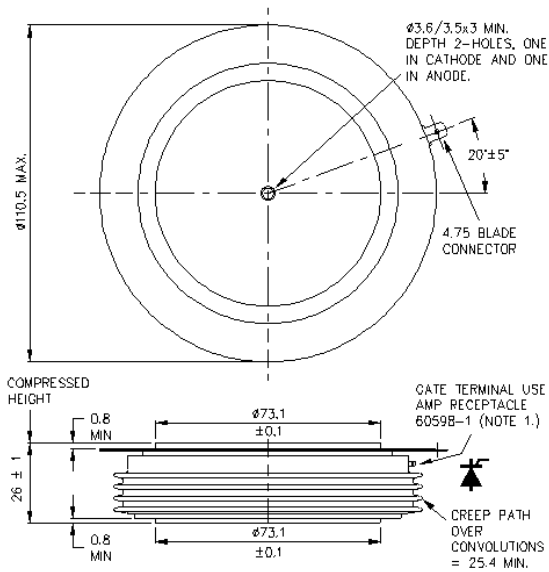

**W46x**

**WC46\***

Device outline W46 is available with a slightly reduced height of 25 mm.

At the time of going to press, this option only applies to two Phase Control Thyristors:  
N3880ZD160-180 and N6012ZD020-060.

Please refer to Chippenham Factory.

**W47 - 100A322**

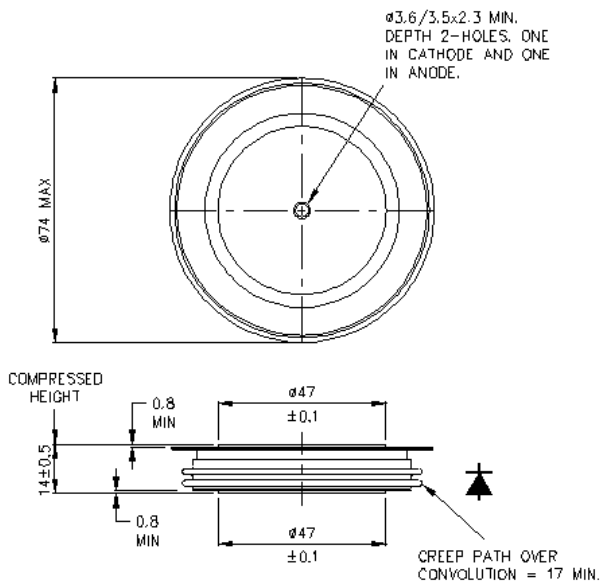

**W48 - 101A347**

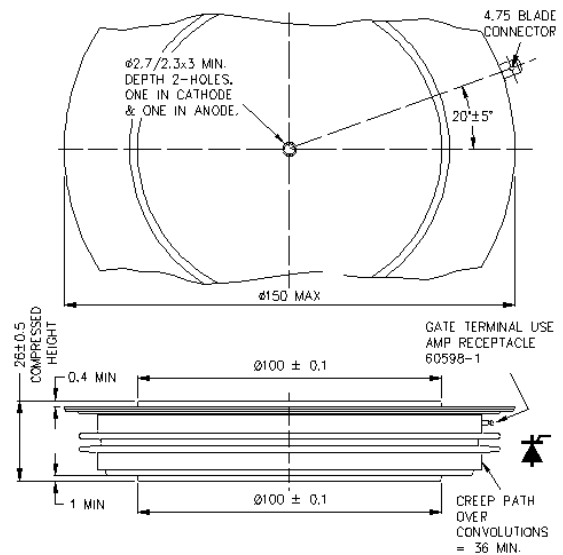

**W51 - 101A334**

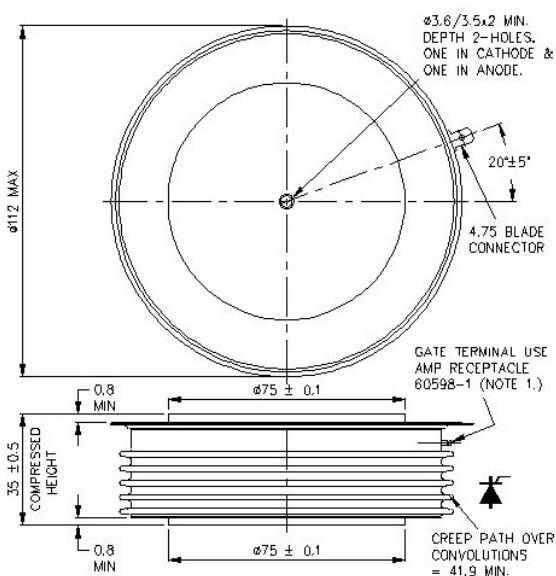

**W52 - 100A328**

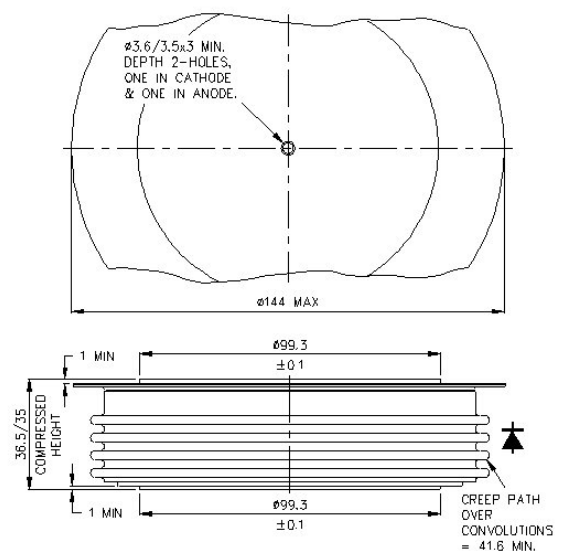

Dimensions in mm and inches (1 mm = 0.0394")

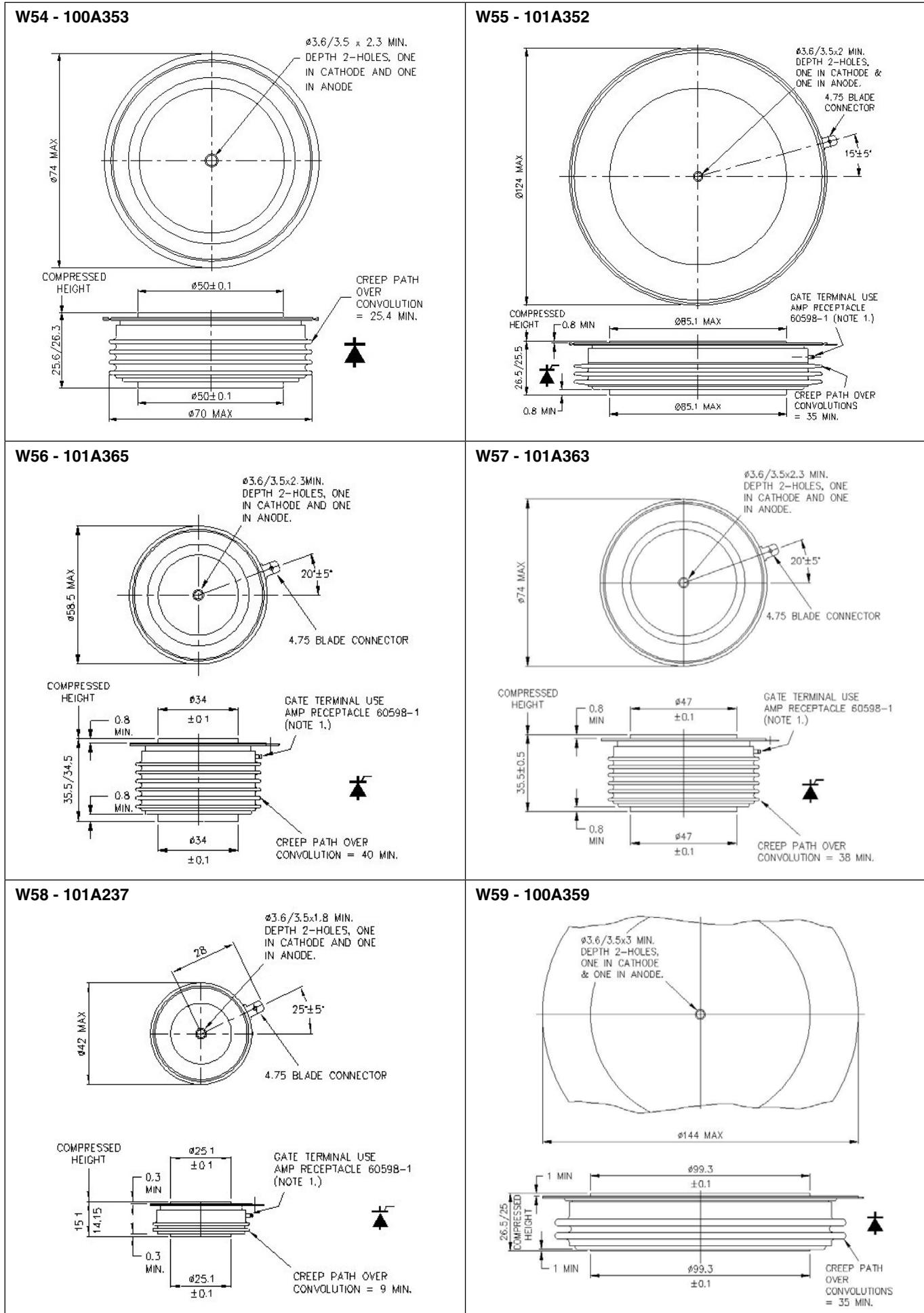

# Outline drawings

Dimensions in mm and inches (1 mm = 0.0394")

**W62 - 101A314**

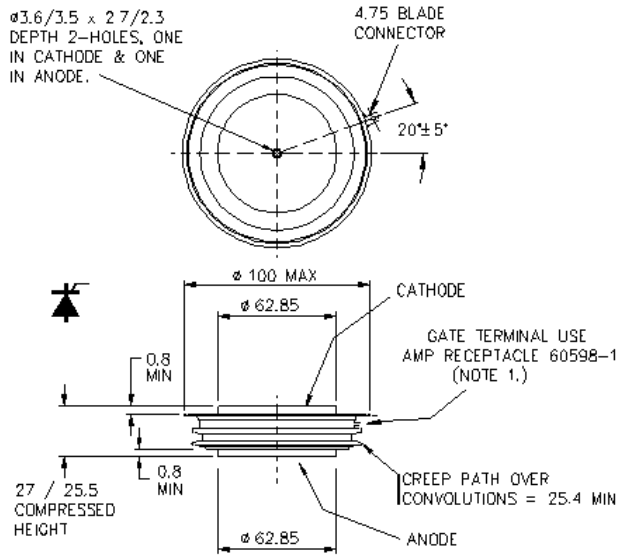

**W63 - 150A111**

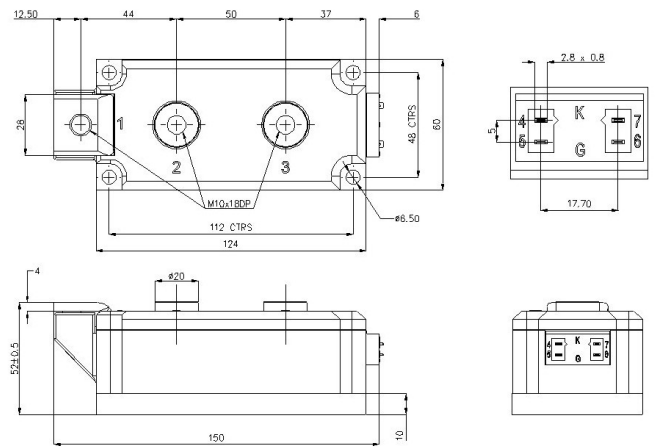

**W64 - 150A113**

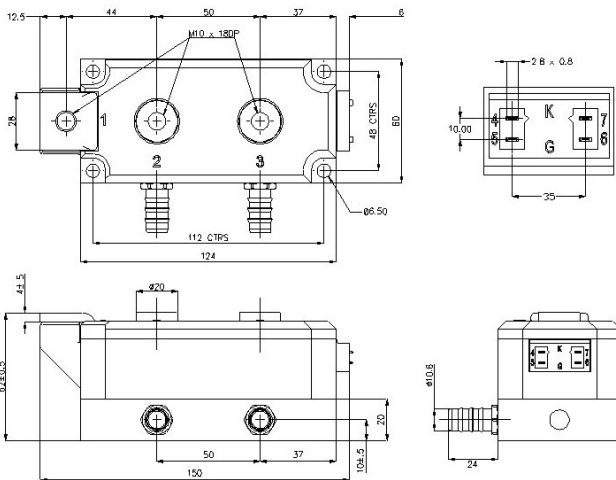

**W67 - 101A366**

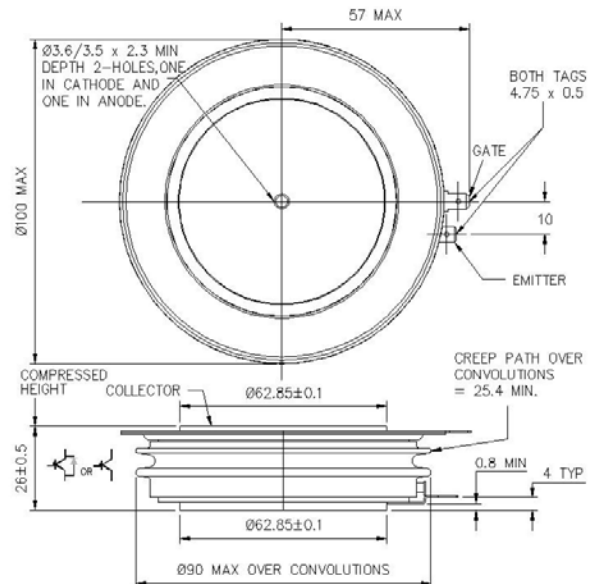

**W68 - 100A367**

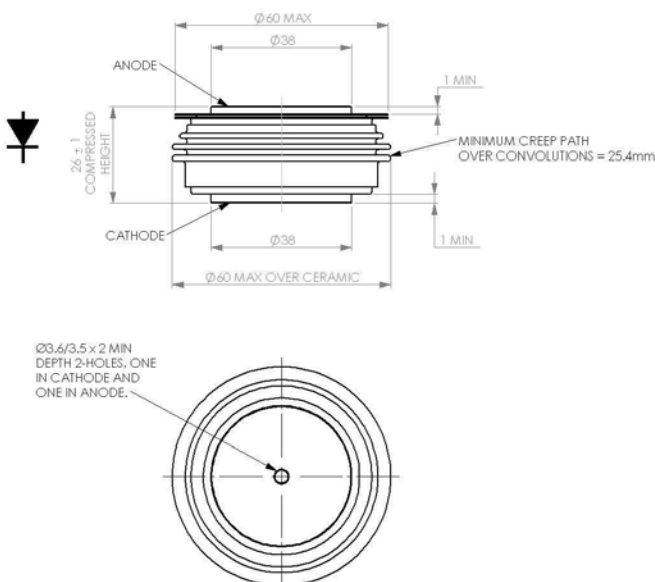

**W70 - 101A357**

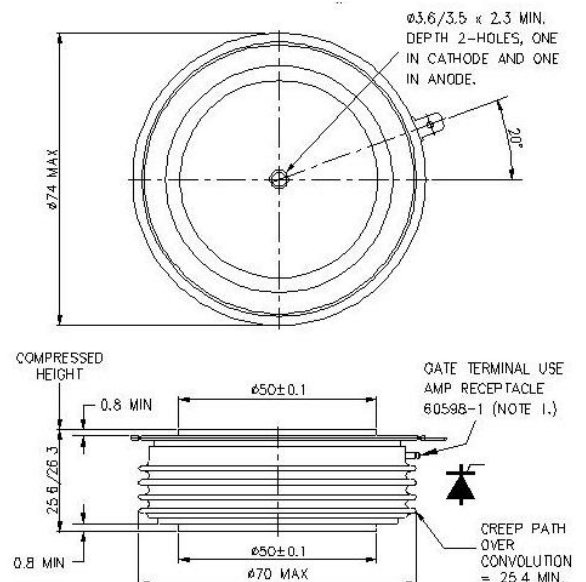



# Outline drawings

Dimensions in mm and inches (1 mm = 0.0394")

**W78 - 101A393**

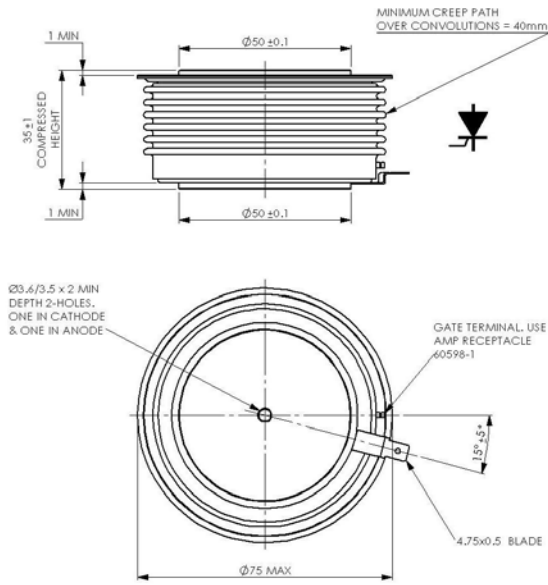

**W81 - 101A373**

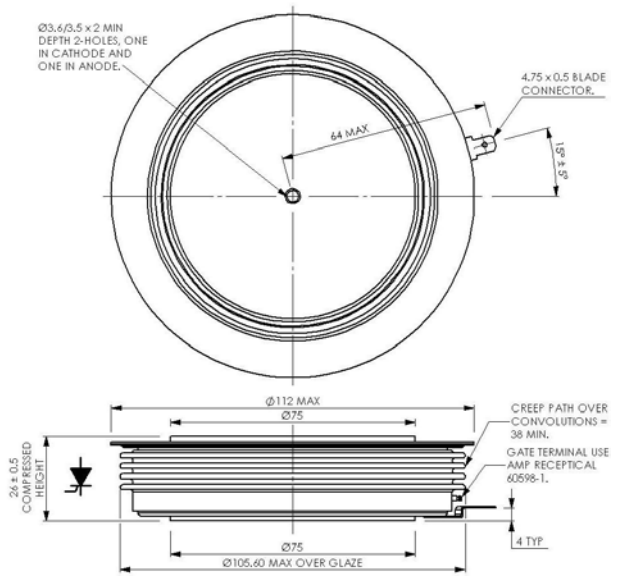

**W82 - 101A395**

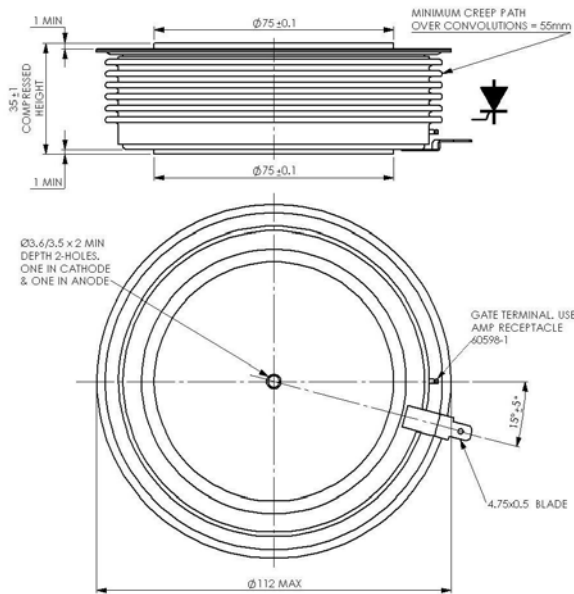

**W85 - 101A388**

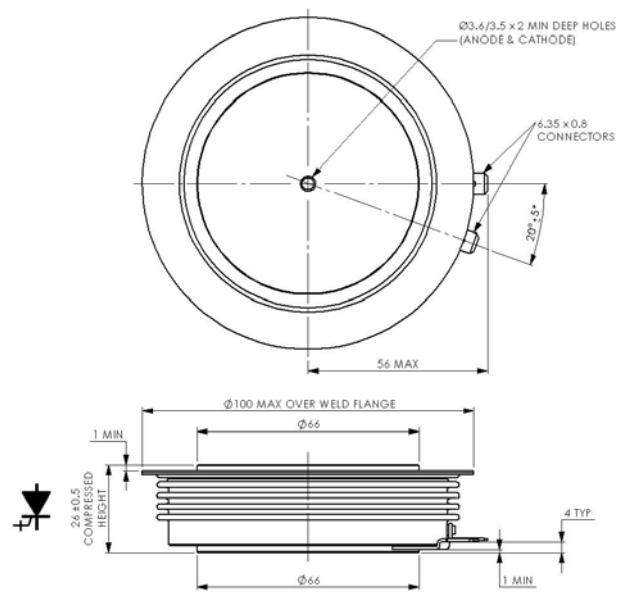

**W86 - 101A316**

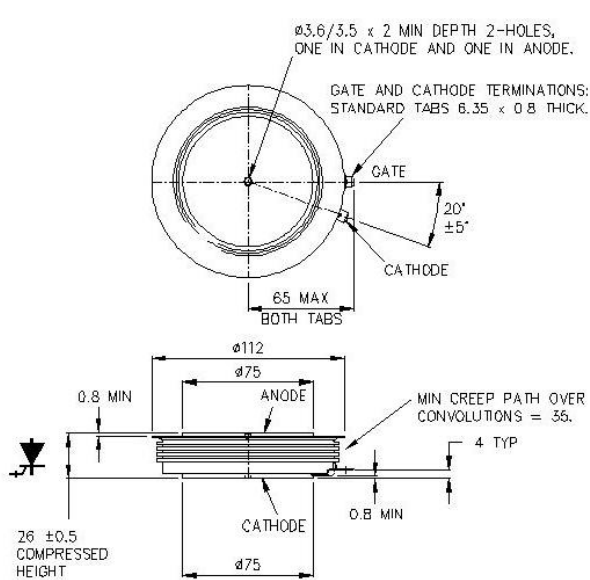

**W87 101A376**

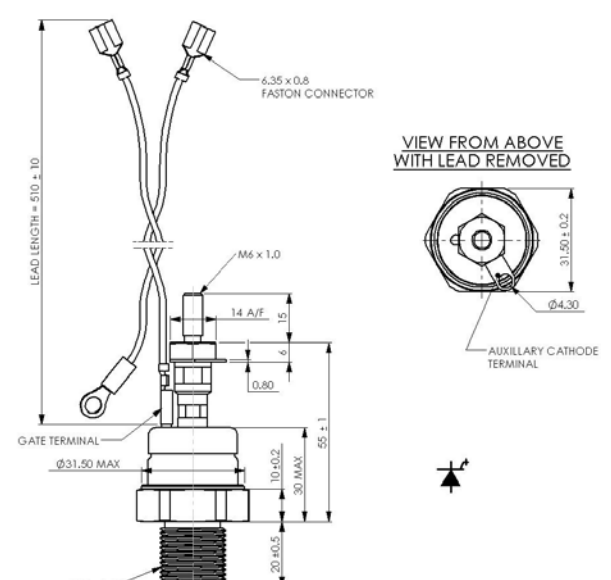

Dimensions in mm and inches (1 mm = 0.0394")

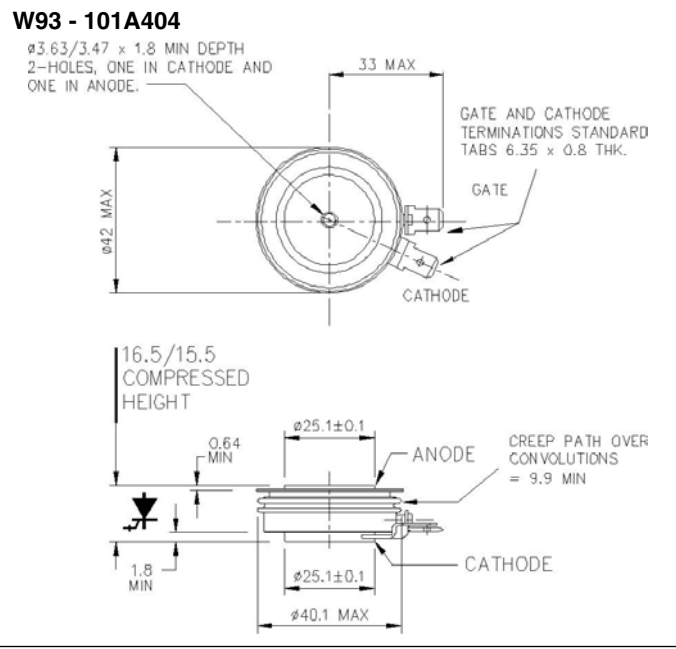
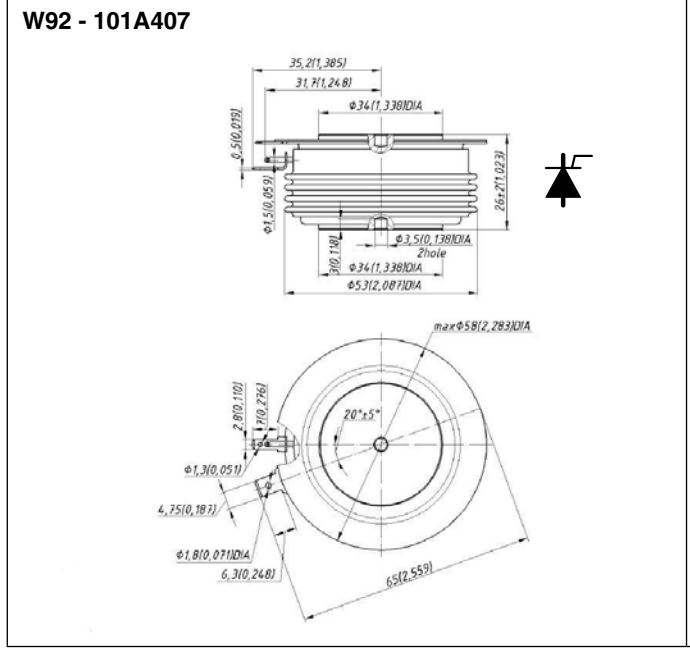
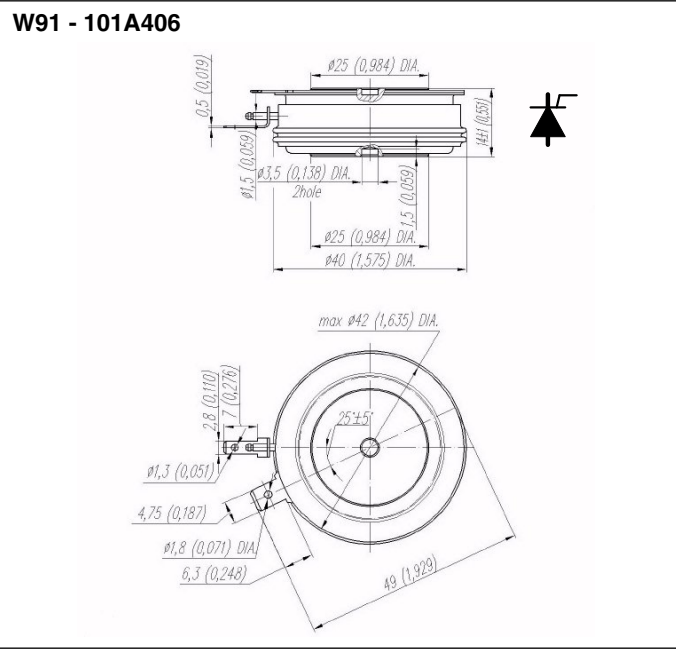
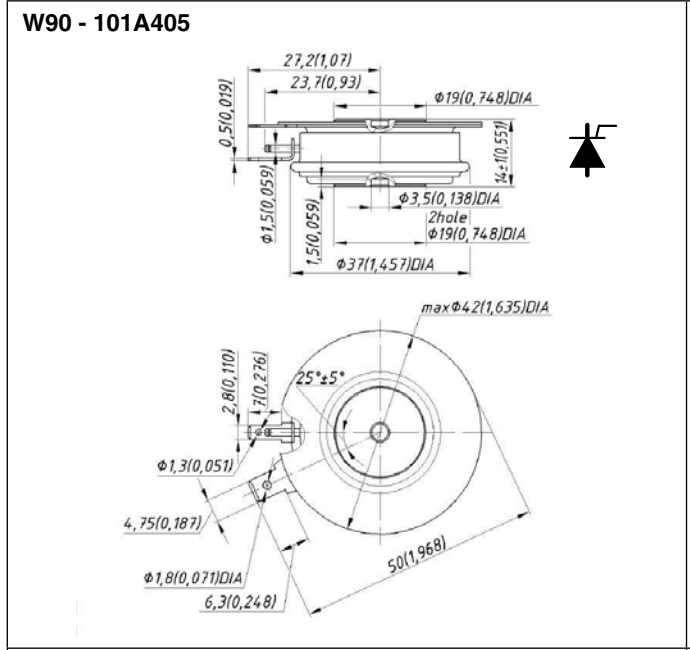
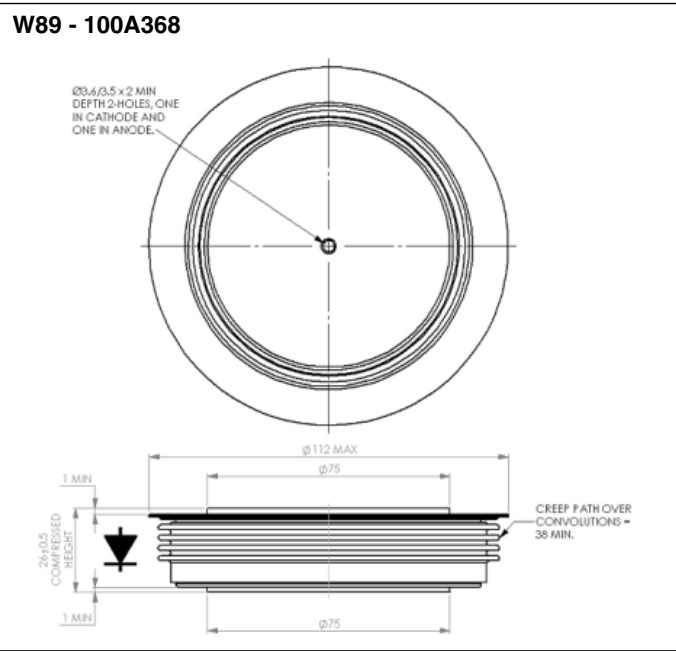
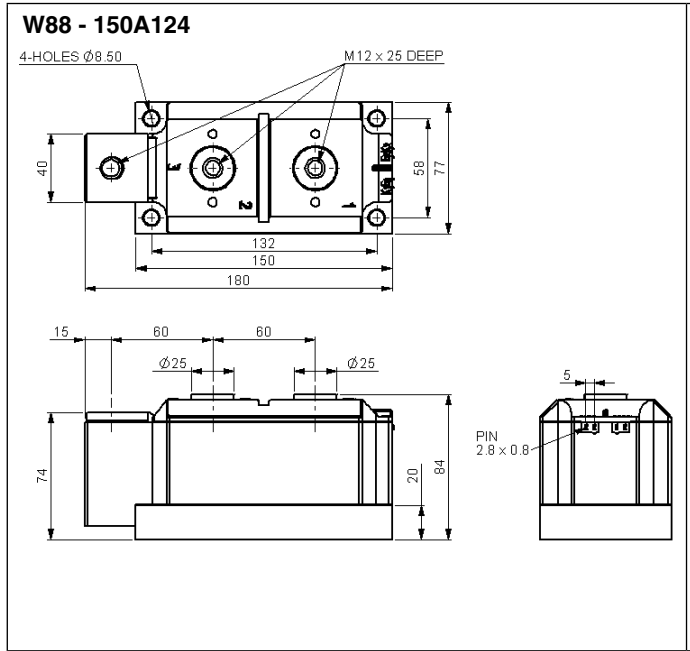

# Outline drawings

Dimensions in mm and inches (1 mm = 0.0394")

## W94 - 100A372

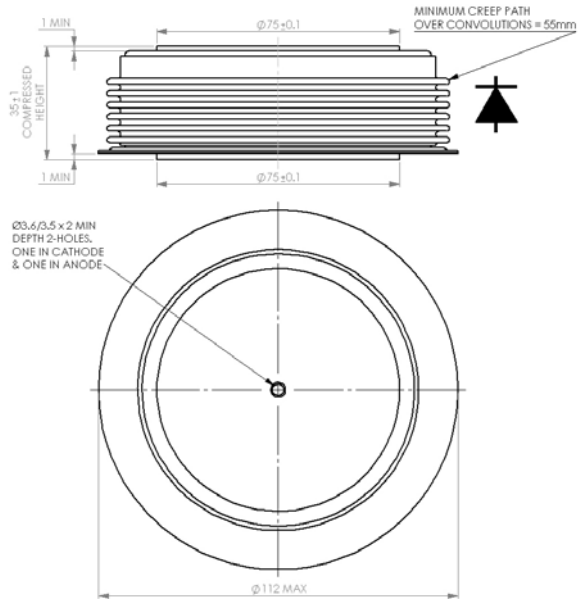

Dimensions in mm and inches (1 mm = 0.0394")

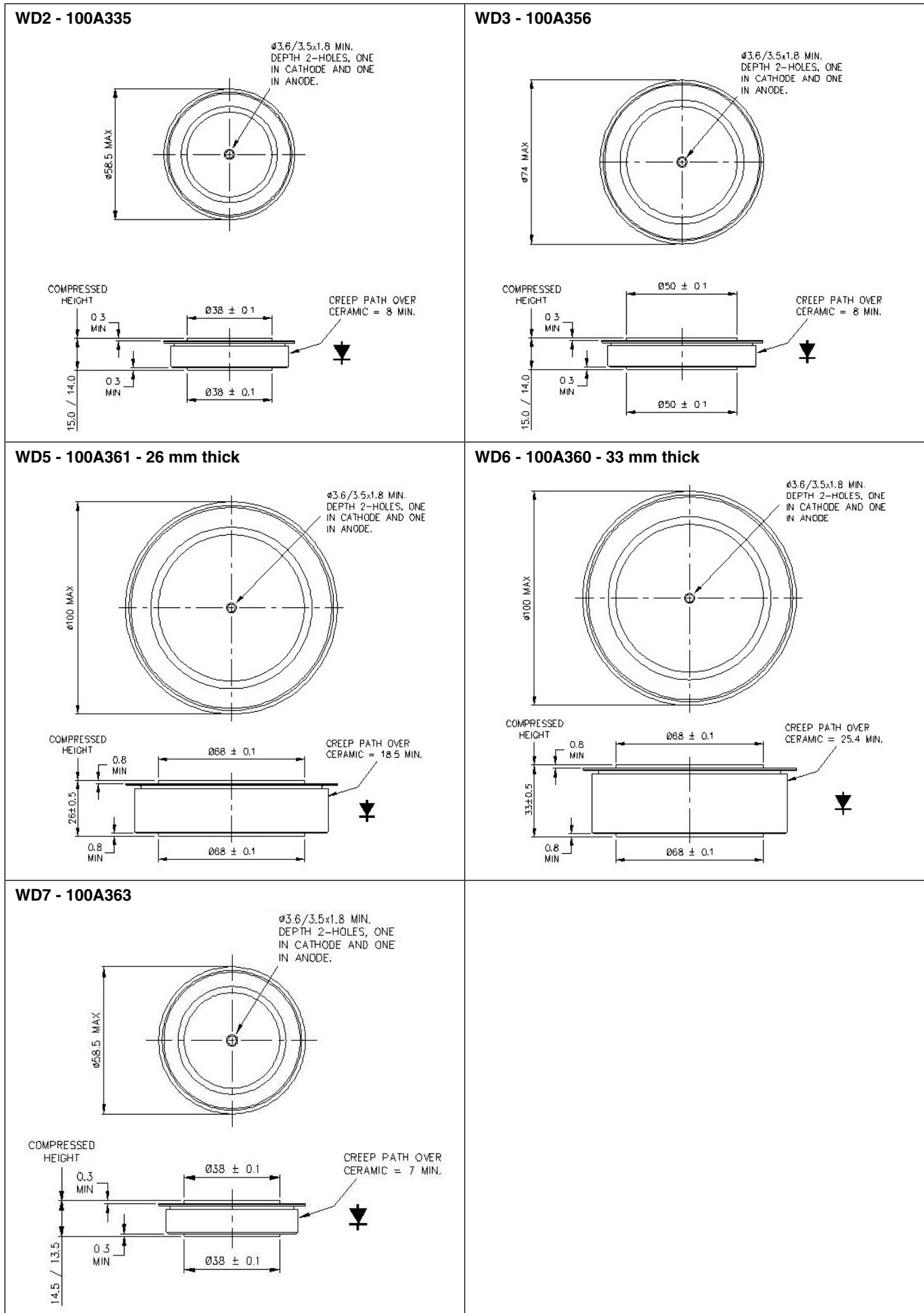



# Outline drawings

Dimensions in mm and inches (1 mm = 0.0394")

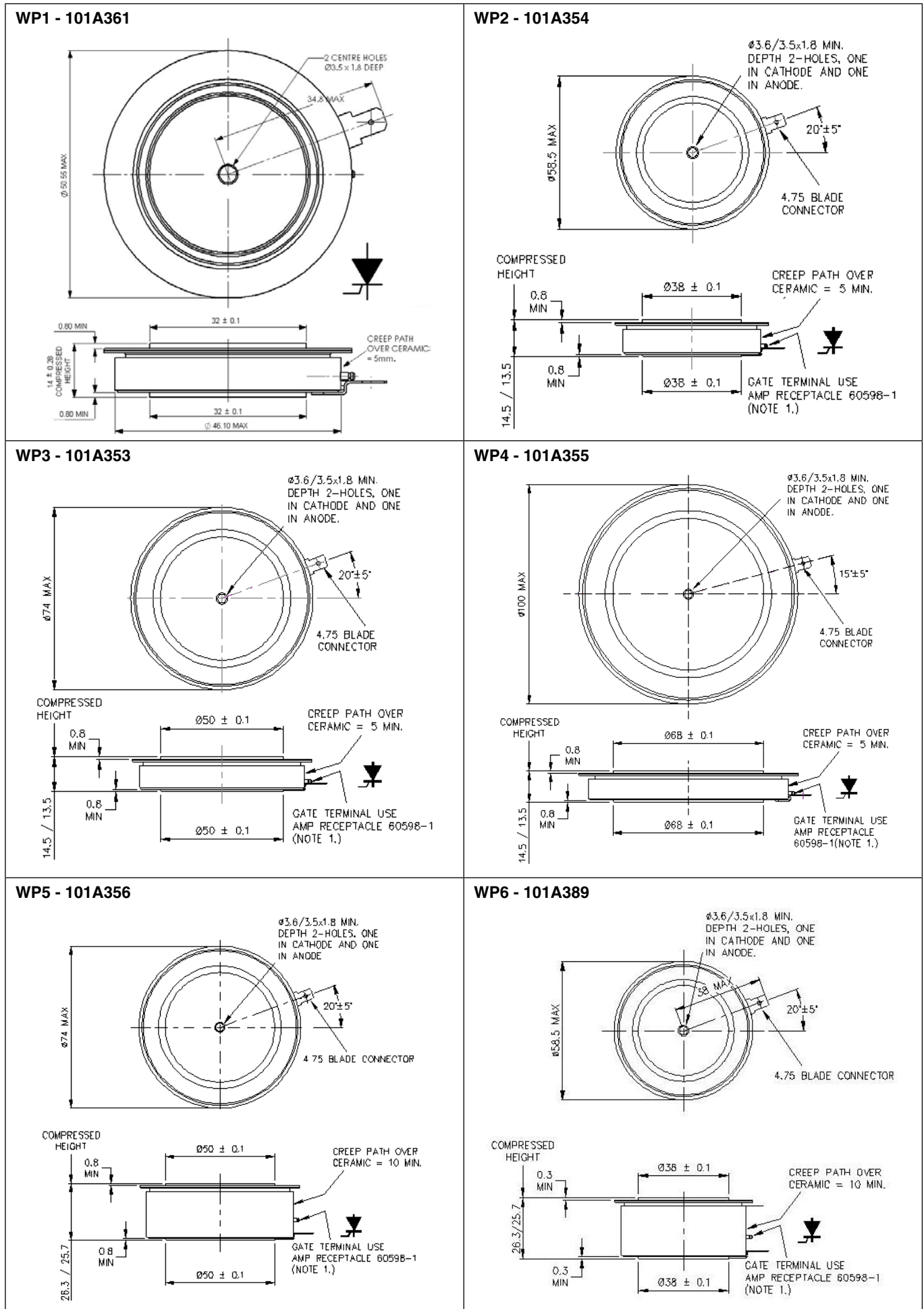

Dimensions in mm and inches (1 mm = 0.0394")

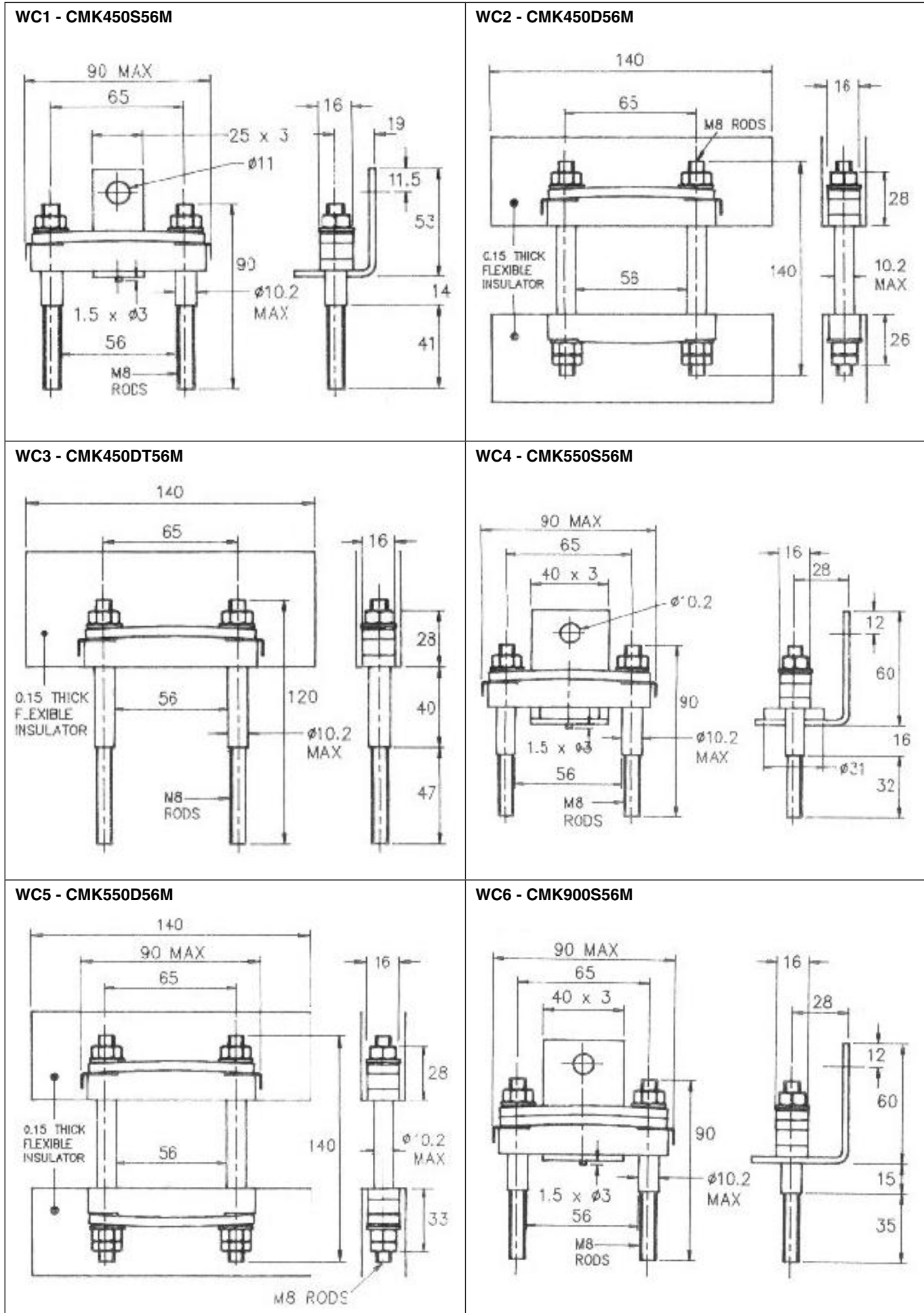

# Outline drawings

Dimensions in mm and inches (1 mm = 0.0394")

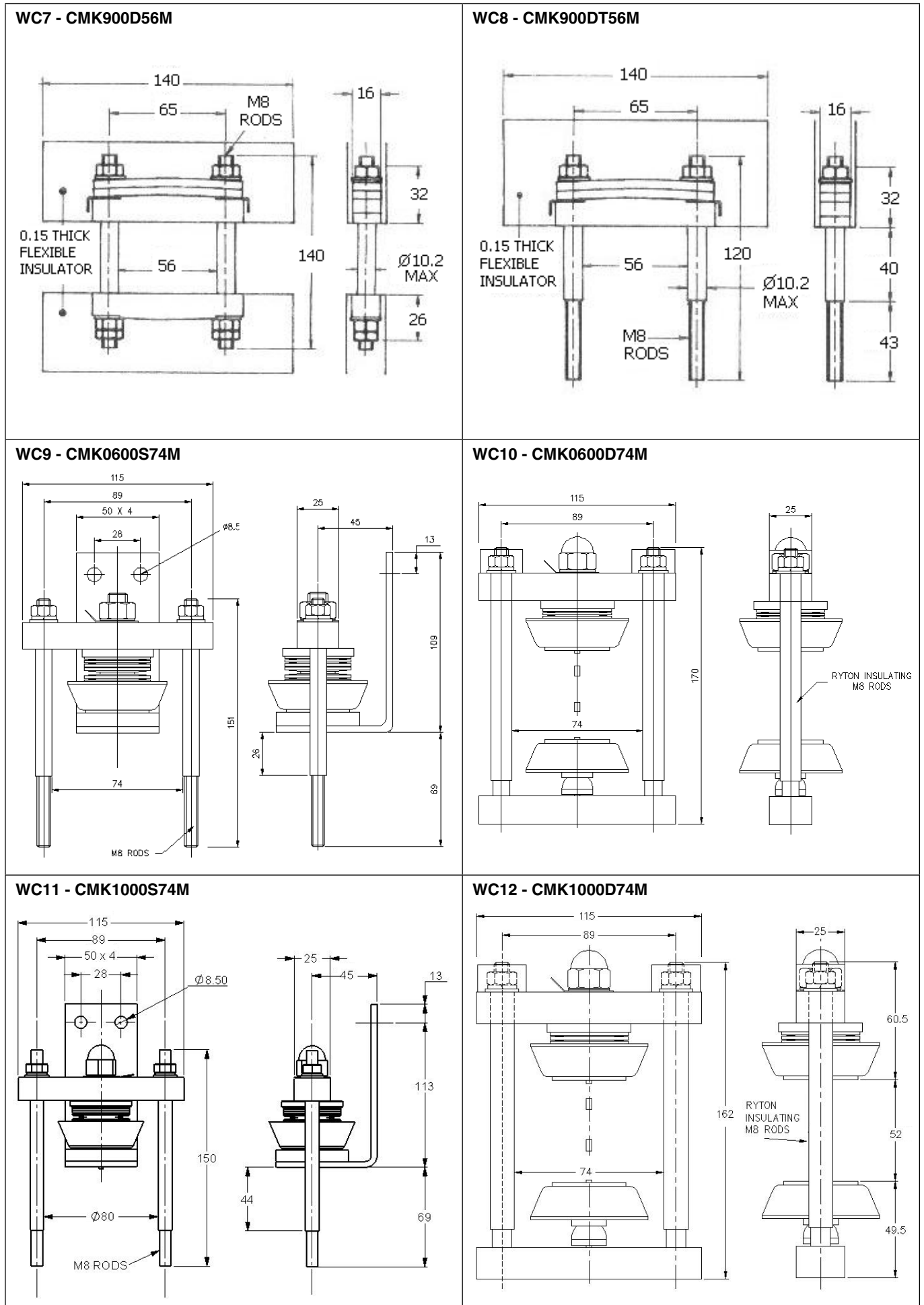

Dimensions in mm and inches (1 mm = 0.0394")

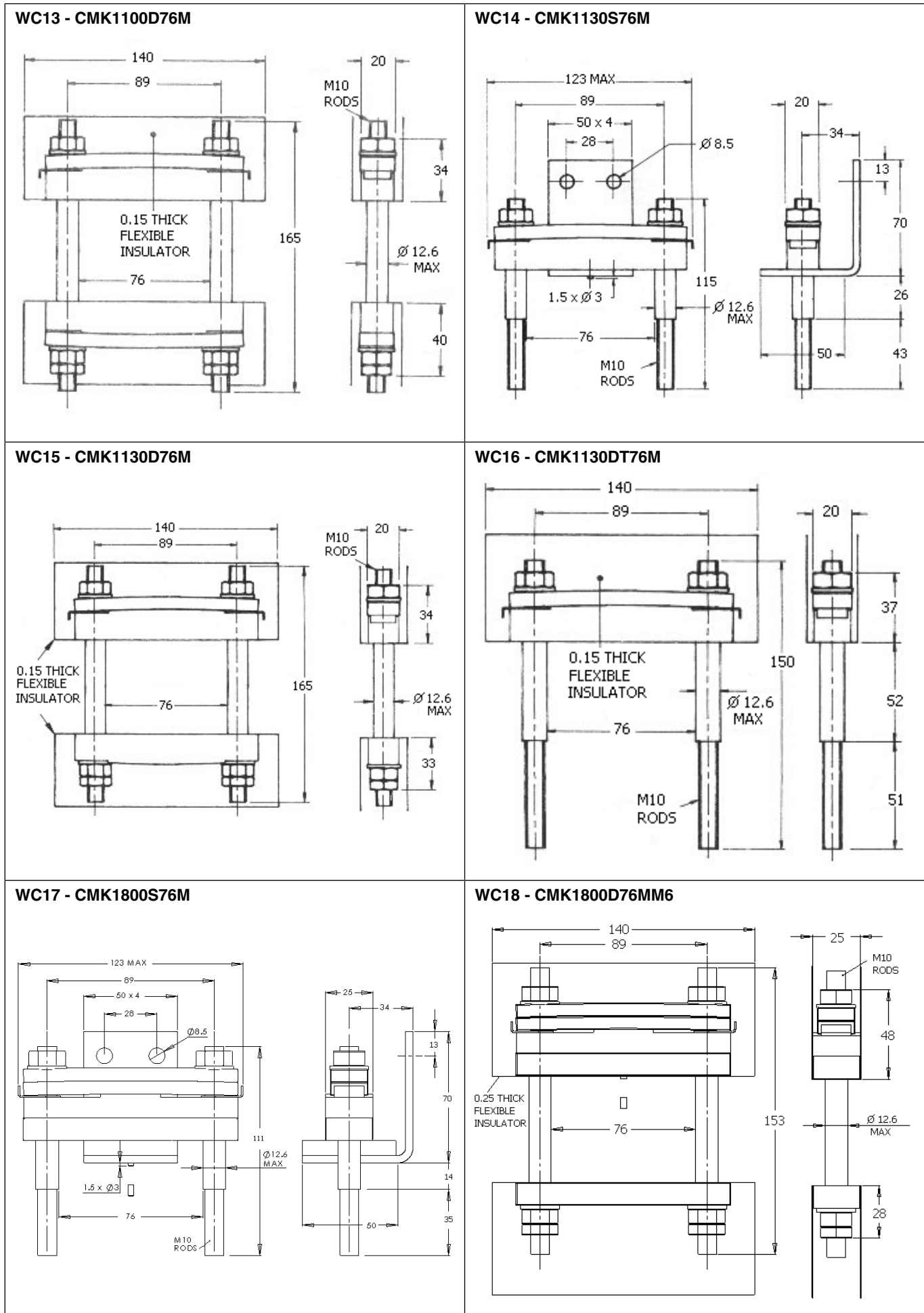

# Outline drawings

Dimensions in mm and inches (1 mm = 0.0394")

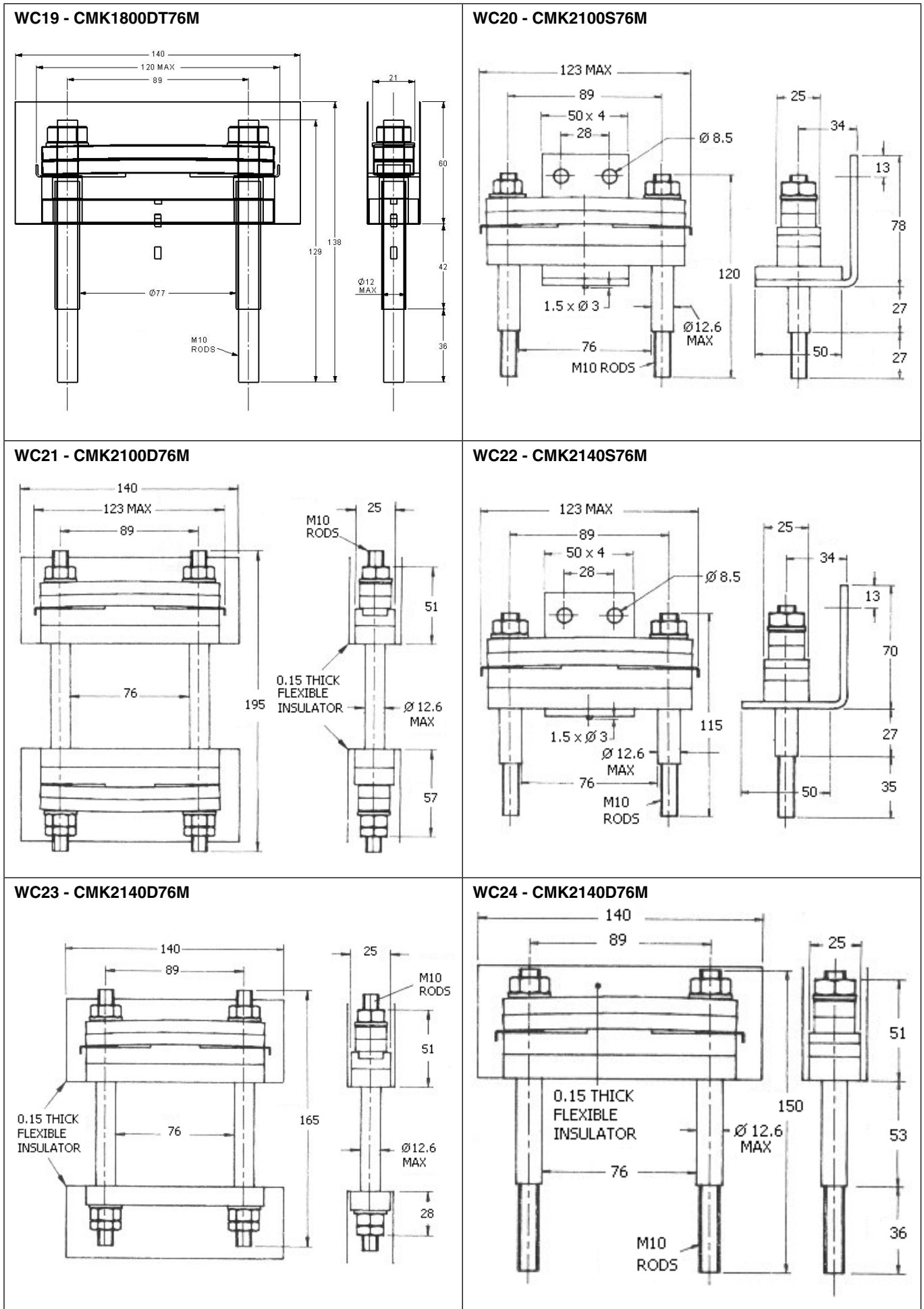

Dimensions in mm and inches (1 mm = 0.0394")

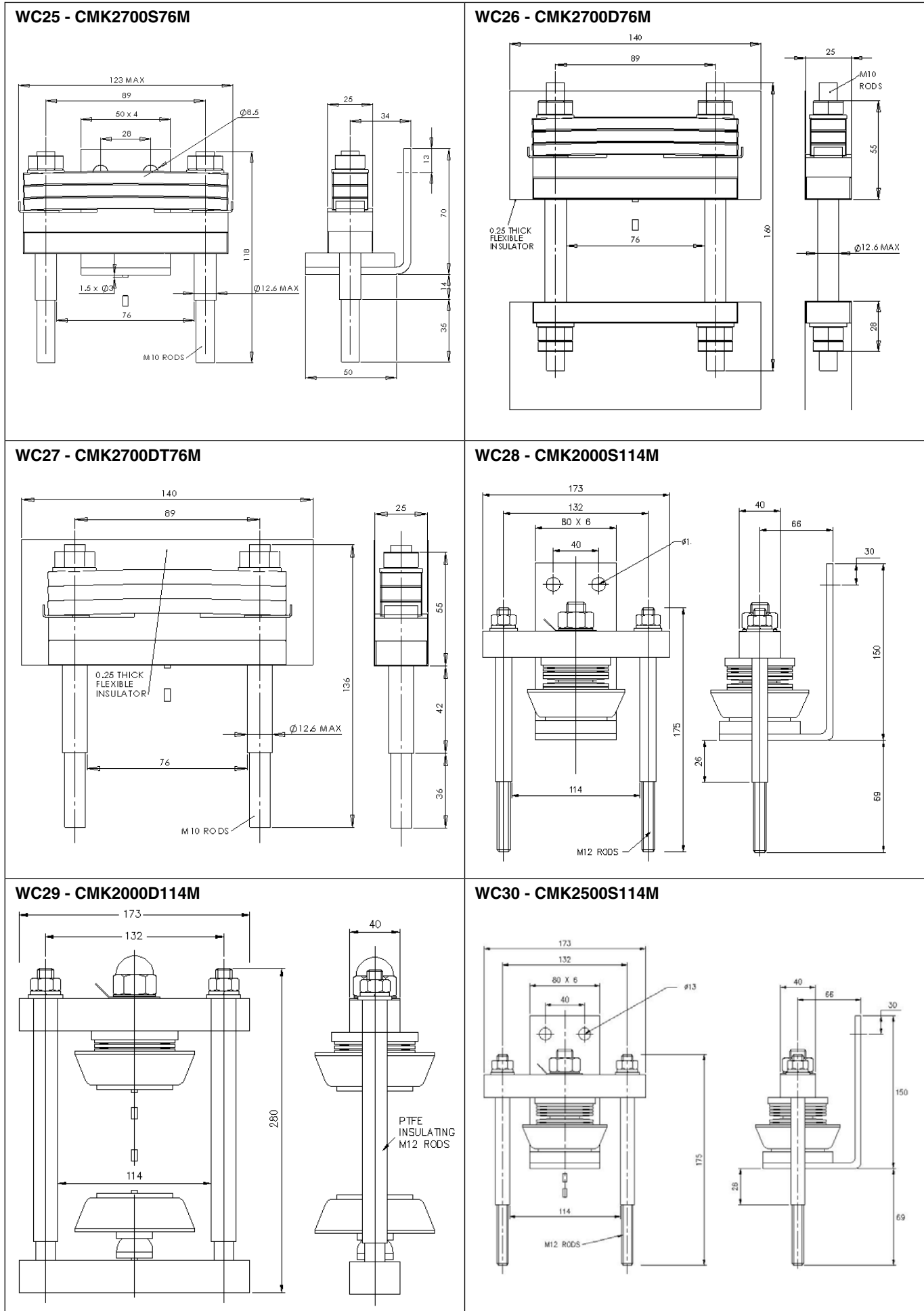

# Outline drawings

Dimensions in mm and inches (1 mm = 0.0394")

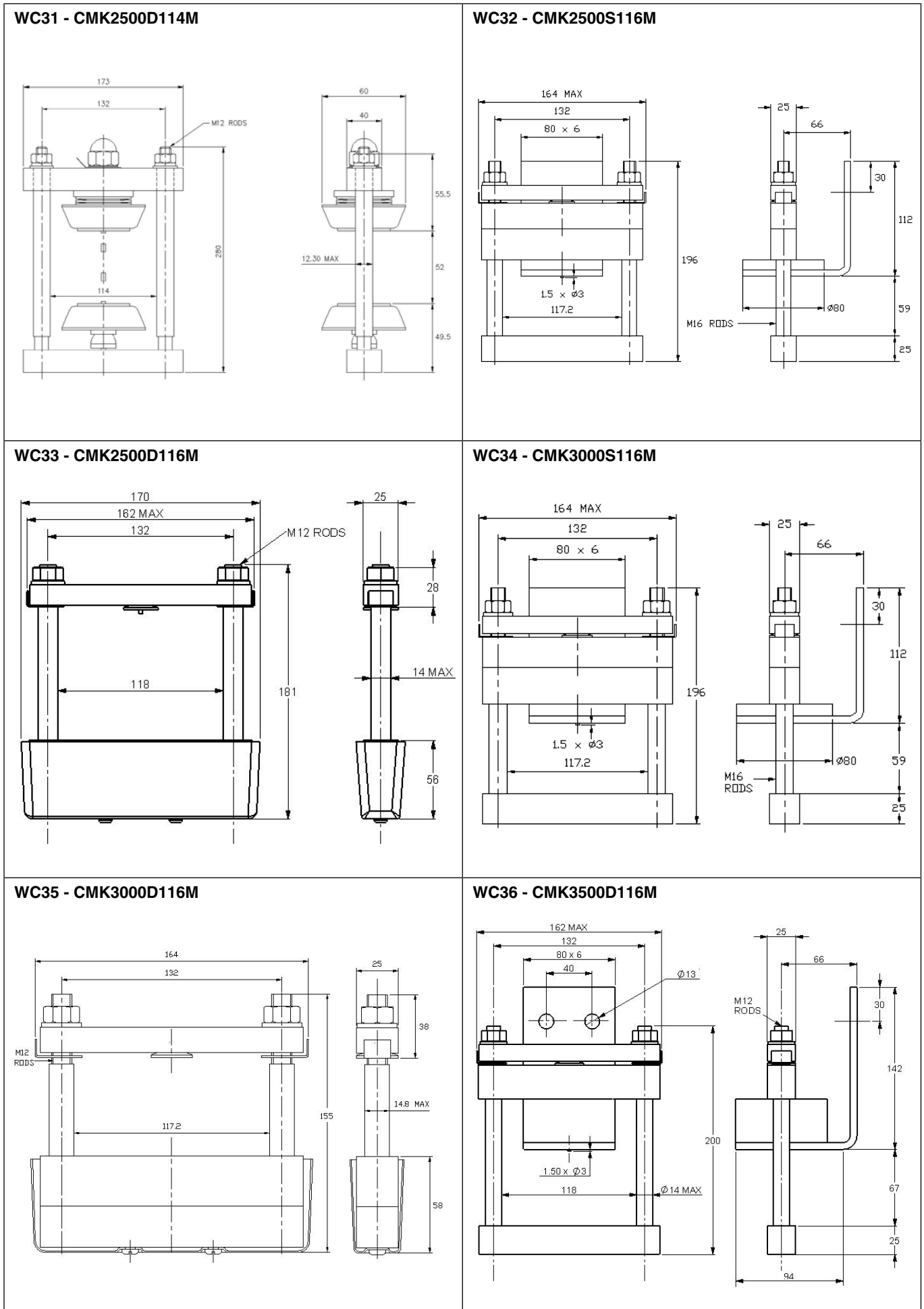

Dimensions in mm and inches (1 mm = 0.0394")

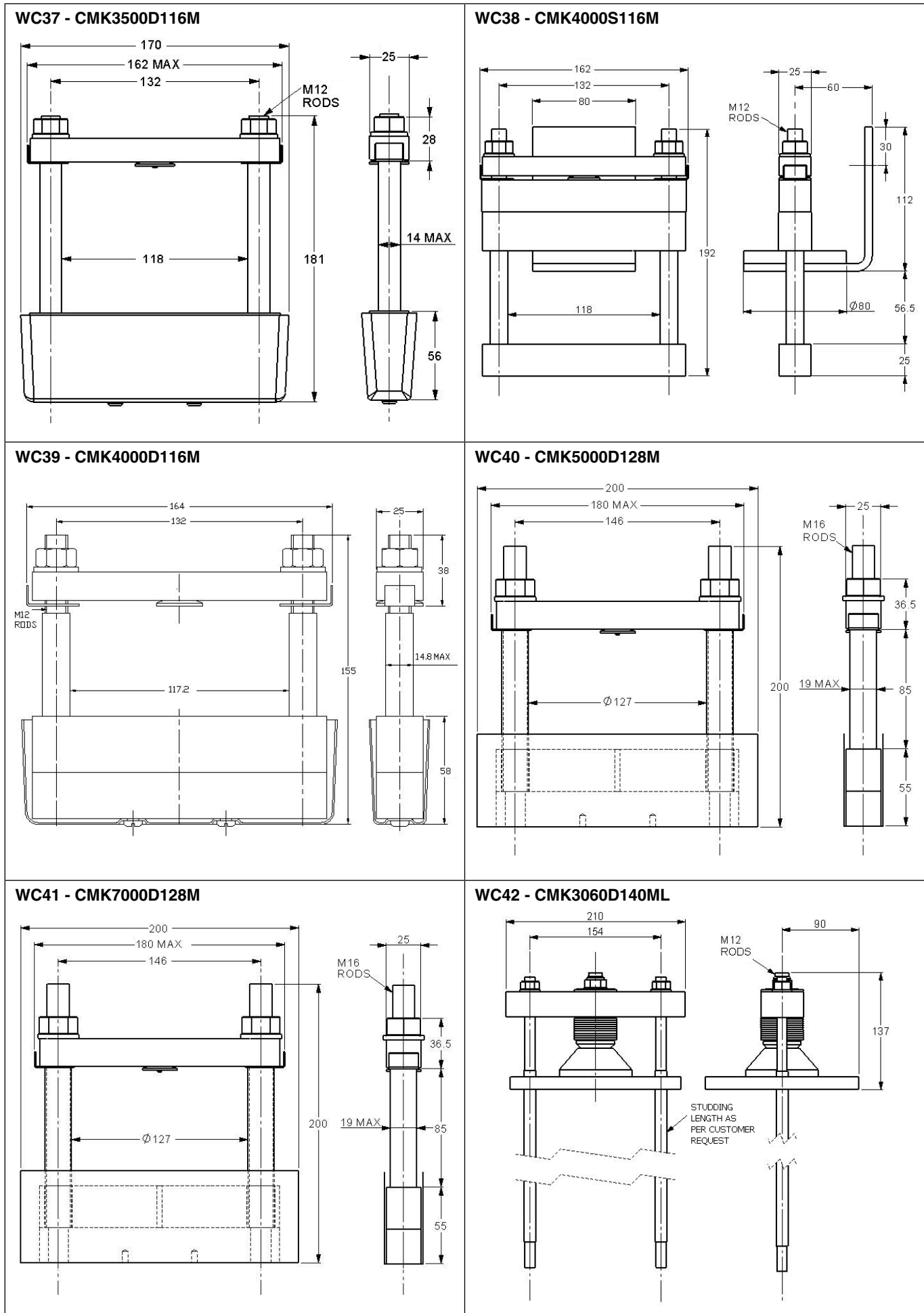



# Outline drawings

Dimensions in mm and inches (1 mm = 0.0394")

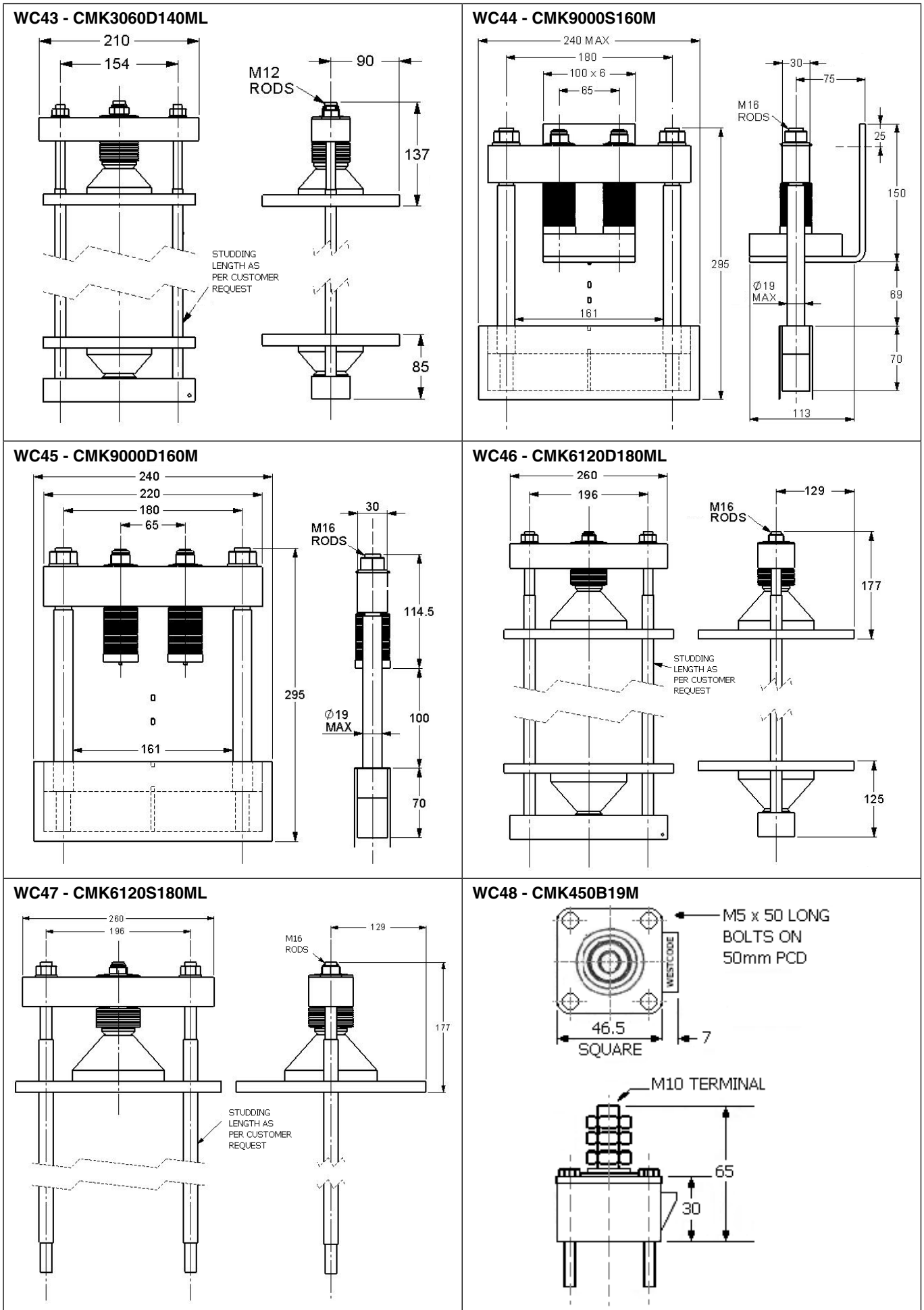

Dimensions in mm and inches (1 mm = 0.0394")

**WC49 - CMK450B25M**

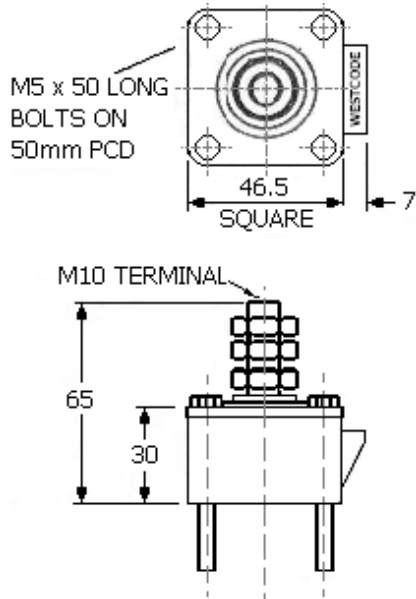

**WC50 - CMK150B34M**

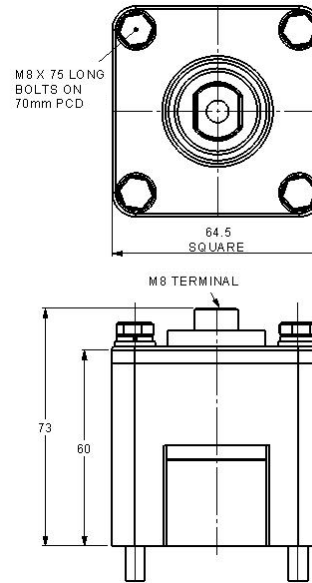

**WC51 XSK1500DA076xxx**

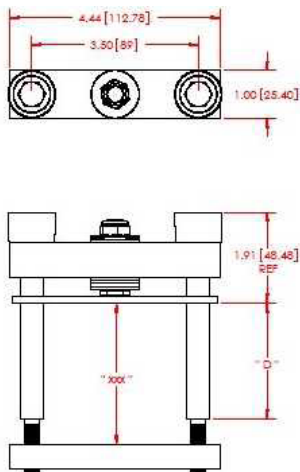

**Notes:**

1. DIMENSIONS IN INCHES [ MILLIMETERS ].
2. " Z " DIMENSION CAN BE CHANGED AS PER REQUIREMENT.
3. " D " DIMENSION CAN BE CHANGED AS PER REQUIREMENT.

**WC52 XSK2000DA076xxx**

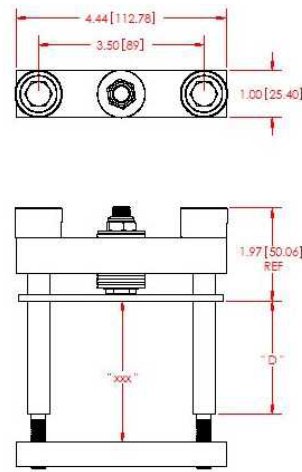

**Notes:**

1. DIMENSIONS IN INCHES [ MILLIMETERS ].
2. " Z " DIMENSION CAN BE CHANGED AS PER REQUIREMENT.
3. " D " DIMENSION CAN BE CHANGED AS PER REQUIREMENT.

**WC53 XSK3000DA076xxx**

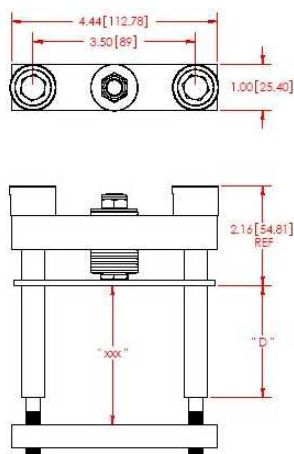

**Notes:**

1. DIMENSIONS IN INCHES [ MILLIMETERS ].
2. " Z " DIMENSION CAN BE CHANGED AS PER REQUIREMENT.
3. " D " DIMENSION CAN BE CHANGED AS PER REQUIREMENT.

**WC54 XSK3400DA076xxx**

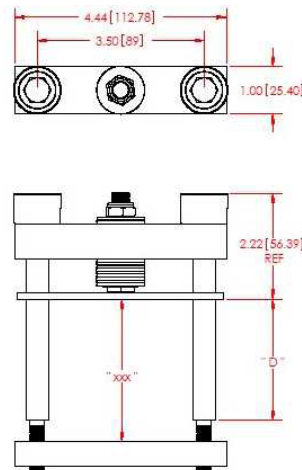

**Notes:**

1. DIMENSIONS IN INCHES [ MILLIMETERS ].
2. " Z " DIMENSION CAN BE CHANGED AS PER REQUIREMENT.
3. " D " DIMENSION CAN BE CHANGED AS PER REQUIREMENT.

Dimensions in mm and inches (1 mm = 0.0394")

**WC55 XSK3800DA116xxx**

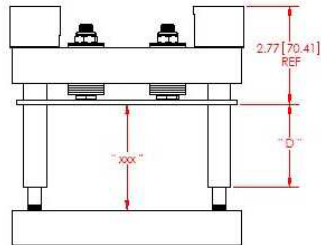
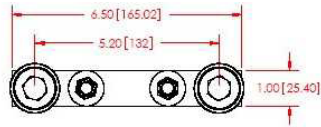

**Notes:**

1. DIMENSIONS IN INCHES [ MILLIMETERS ].
2. " Z " DIMENSION CAN BE CHANGED AS PER REQUIREMENT.
3. " D " DIMENSION CAN BE CHANGED AS PER REQUIREMENT.

**WC56 XSK4400DA116xxx**

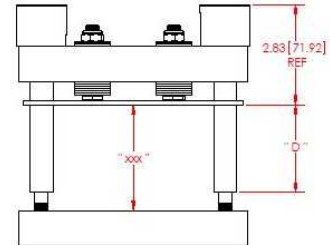
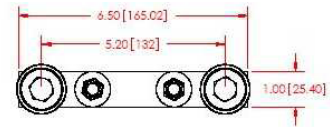

**Notes:**

1. DIMENSIONS IN INCHES [ MILLIMETERS ].
2. " Z " DIMENSION CAN BE CHANGED AS PER REQUIREMENT.
3. " D " DIMENSION CAN BE CHANGED AS PER REQUIREMENT.

**WC57 XSK6000DA116xxx**

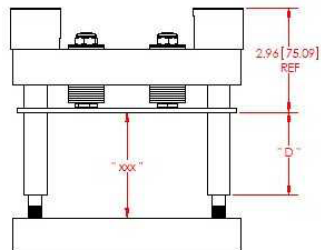
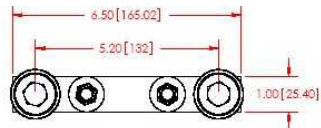

**Notes:**

1. DIMENSIONS IN INCHES [ MILLIMETERS ].
2. " Z " DIMENSION CAN BE CHANGED AS PER REQUIREMENT.
3. " D " DIMENSION CAN BE CHANGED AS PER REQUIREMENT.

**WC58 DA**

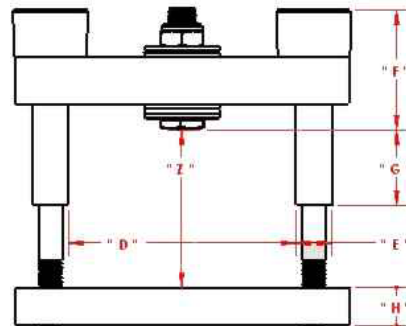
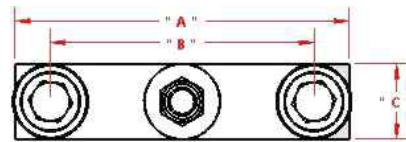

**WC59 DT**

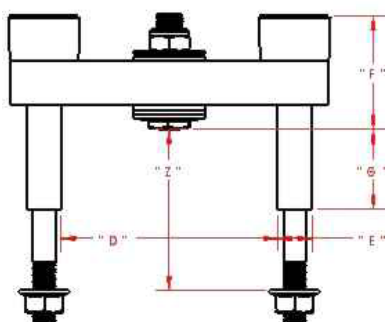
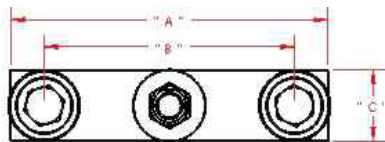

**WC60 DF**

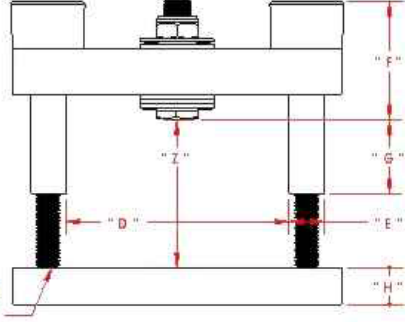
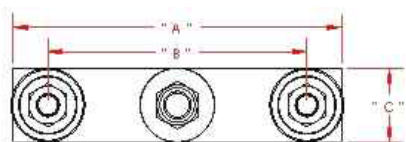

NOB'S LOCITE INTO THE BOTTOM BAR [ALL THE WAY]

Dimensions in mm and inches (1 mm = 0.0394")

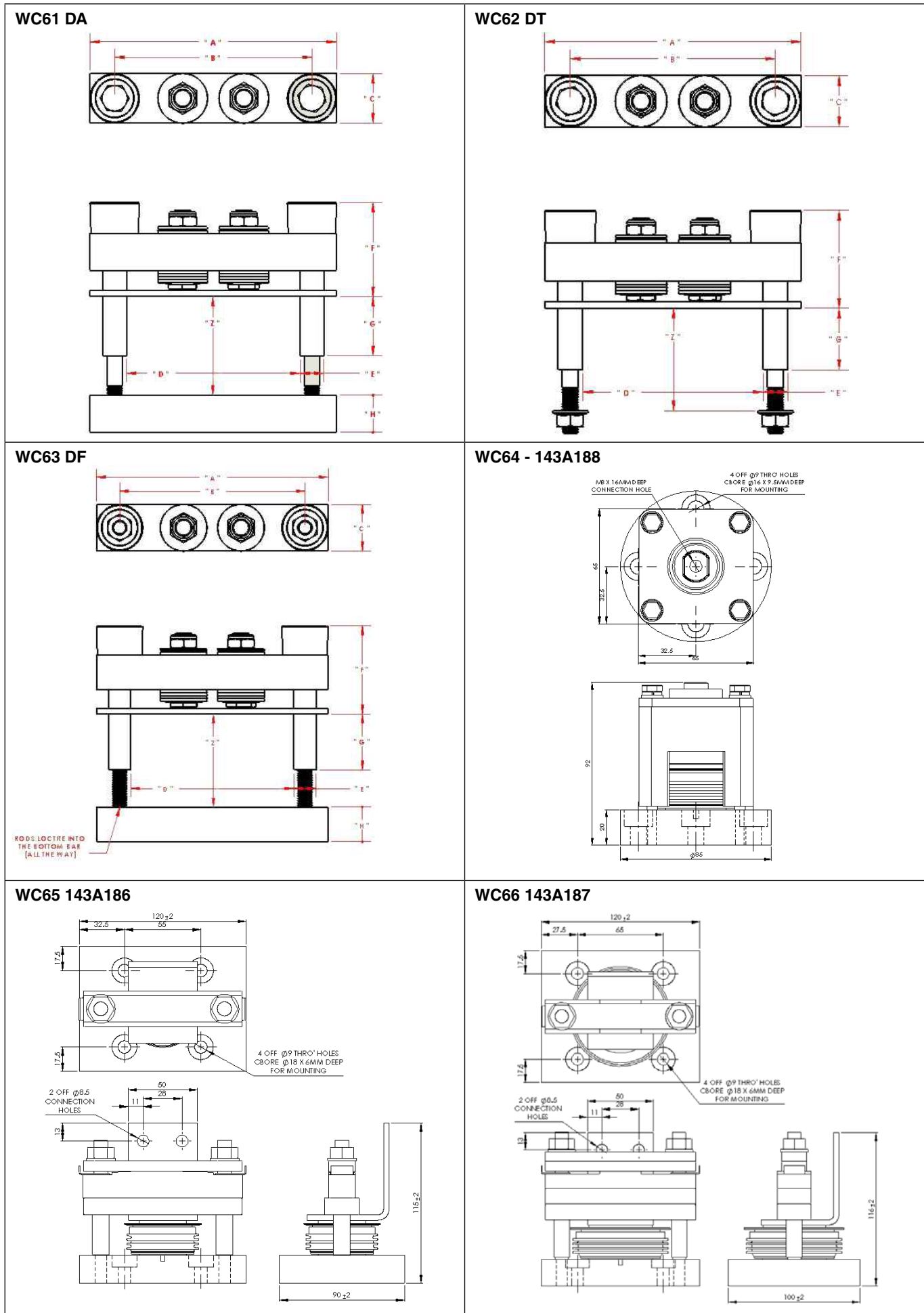

# Outline drawings

Dimensions in mm and inches (1 mm = 0.0394")

<p><b>WH1 - G FIN</b></p> <p>68 50 44 90</p>	<p><b>WH2 - GA FIN</b></p> <p>100 72 64 120</p>	<p><b>WH3 - H FIN</b></p> <p>84 79 10 27 142 178</p>
<p><b>WH4 - T FIN</b></p> <p>290 172 123 79 84 26 160</p>	<p><b>WH5 - TB FIN</b></p> <p>142 115 30 240</p>	<p><b>WH6 - TC FIN</b></p> <p>110 10 120 23 47 200 222</p>
<p><b>WH7 - LP100</b></p> <p>222 20 100 3</p>	<p><b>WH8 - WS46</b></p> <p>270 210 60.5 49.5 38</p>	<p><b>WH9 - WS30 - COPPER</b></p> <p>19 93 175 125 89 125</p>

Dimensions in mm and inches (1 mm = 0.0394")

<p><b>WCL1 - LK COOLER</b></p>	<p><b>WCL2 - LKA COOLER</b></p>	<p><b>WCL3 - LKB COOLER</b></p>
<p><b>WCL4 - LKC COOLER</b></p>	<p><b>WCL5 - LKD COOLER</b></p>	<p><b>WCL6 - LKE COOLER</b></p>
<p><b>WCL7 LKF</b></p>	<p><b>WCL8 WS27</b></p>	<p><b>WCL9 - WS65 COOLER</b></p>

# Outline drawings

Dimensions in mm and inches (1 mm = 0.0394")

<p><b>WCL10 - WS69 COOLER</b></p>	<p><b>WCL11 - WS70 COOLER</b></p>	<p><b>WCL12 - WS71-1 COOLER</b></p>
<p><b>WCL13 - WS71-2 COOLER</b></p>	<p><b>WCL14 - WS72-1 COOLER</b></p>	<p><b>WCL15 - WS72-2 COOLER</b></p>
<p><b>WCL16 XW127ExxxA</b></p>	<p><b>WCL17 XW127ExxxB</b></p>	<p><b>WCL18 XW180GN25A</b></p>

Dimensions in mm and inches (1 mm = 0.0394")

**X003 TO-251 AA** Weight = 0.4 g

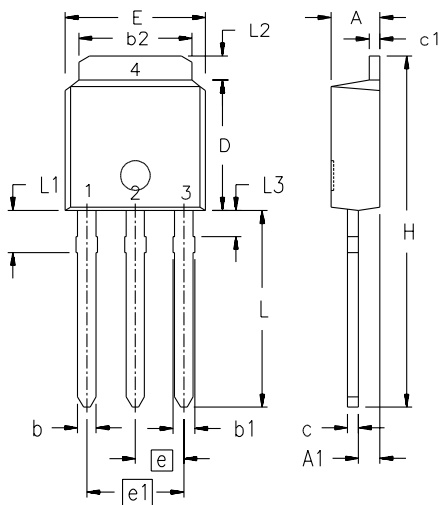

Dim.	Millimeters		Inches	
	min	max	min	max
A	2.19	2.38	0.086	0.094
A1	0.89	1.14	0.035	0.045
b	0.64	0.89	0.025	0.035
b1	0.76	1.14	0.030	0.045
b2	5.21	5.46	0.205	0.215
c	0.46	0.58	0.018	0.023
c1	0.46	0.58	0.018	0.023
D	5.97	6.22	0.235	0.245
E	6.35	6.73	0.250	0.265
e	2.28 BSC		0.090 BSC	
e1	4.57 BSC		0.180 BSC	
H	17.02	17.78	0.670	0.700
L	8.89	9.65	0.350	0.380
L1	1.91	2.28	0.075	0.090
L2	0.89	1.27	0.035	0.050
L3	1.15	1.52	0.045	0.060

**X004 TO-252 AA (D PAK)** Weight = 0.3 g

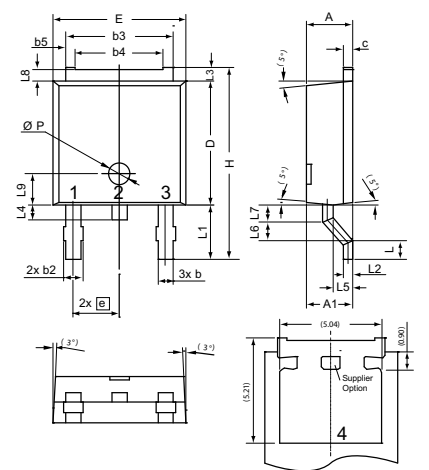

Dim.	Millimeters		Inches	
	min	max	min	max
A	2.20	2.40	0.087	0.094
A1	2.10	2.50	0.083	0.098
b	0.66	0.86	0.026	0.034
b2	-	0.96	-	0.038
b3	5.04	5.64	0.198	0.222
b4	4.34 BSC		0.171 BSC	
b5	0.50 BSC		0.020 BSC	
c	0.40	0.60	0.016	0.024
D	5.90	6.30	0.232	0.248
E	6.40	6.80	0.252	0.268
e	2.10	2.50	0.083	0.098
H	9.20	9.80	0.362	0.386
L	0.55	1.02	0.022	0.040
L1	2.50	2.90	0.098	0.114
L2	0.40	0.60	0.016	0.024
L3	0.50	0.90	0.020	0.035
L4	0.60	1.00	0.024	0.039
L5	0.82	1.22	0.032	0.048
L6	0.79	0.99	0.031	0.039
L7	0.81	1.01	0.032	0.040
L8	0.40	0.80	0.016	0.031
L9	1.50 BSC		0.059 BSC	
Ø P	1.00 BSC		0.039 BSC	

**X005a TO-220 AB** Weight = 2 g

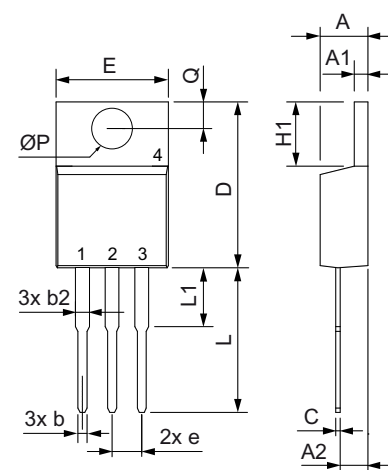

Dim.	Millimeters		Inches	
	min	max	min	max
A	4.32	4.82	0.170	0.190
A1	1.14	1.39	0.045	0.055
A2	2.29	2.79	0.090	0.110
b	0.64	1.01	0.025	0.040
b2	1.15	1.65	0.045	0.065
C	0.35	0.56	0.014	0.022
D	14.73	16.00	0.580	0.630
E	9.91	10.66	0.390	0.420
e	2.54 BSC		0.100 BSC	
H1	5.85	6.85	0.230	0.270
L	12.70	13.97	0.500	0.550
L1	2.79	5.84	0.110	0.230
Ø P	3.54	4.08	0.139	0.161
Q	2.54	3.18	0.100	0.125

**X005b TO-220 AC** Weight = 2 g

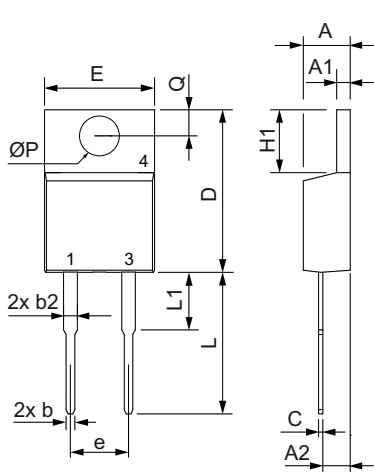

Dim.	Millimeters		Inches	
	min	max	min	max
A	4.32	4.82	0.170	0.190
A1	1.14	1.39	0.045	0.055
A2	2.29	2.79	0.090	0.110
b	0.64	1.01	0.025	0.040
b2	1.15	1.65	0.045	0.065
C	0.35	0.56	0.014	0.022
D	14.73	16.00	0.580	0.630
E	9.91	10.66	0.390	0.420
e	5.08 BSC		0.200 BSC	
H1	5.85	6.85	0.230	0.270
L	12.70	13.97	0.500	0.550
L1	2.79	5.84	0.110	0.230
Ø P	3.54	4.08	0.139	0.161
Q	2.54	3.18	0.100	0.125

**X006 TO-220 (5)** Weight = 2 g

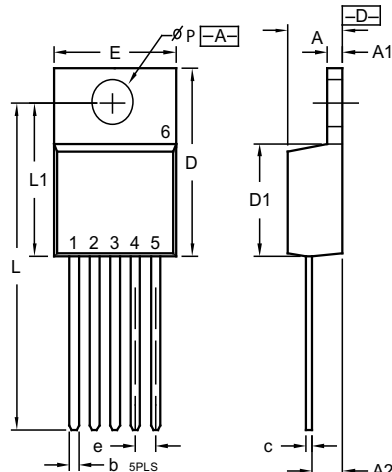

Dim.	Millimeters		Inches	
	min	max	min	max
A	4.32	4.82	0.170	0.190
A1	1.14	1.39	0.045	0.055
A2	2.29	2.79	0.090	0.110
b	0.64	1.01	0.025	0.040
c	0.38	0.64	0.015	0.025
D	14.73	15.75	0.580	0.620
D1	8.64	9.40	0.340	0.370
E	9.91	10.54	0.390	0.415
e	1.70 BSC		0.067 BSC	
k	0.00	0.36	0.000	0.014
L	25.27	26.54	0.995	1.045
L1	11.94	12.95	0.470	0.510
Ø P	3.53	3.96	0.139	0.156

**X007a TO-220 ABFP** Weight = 2 g

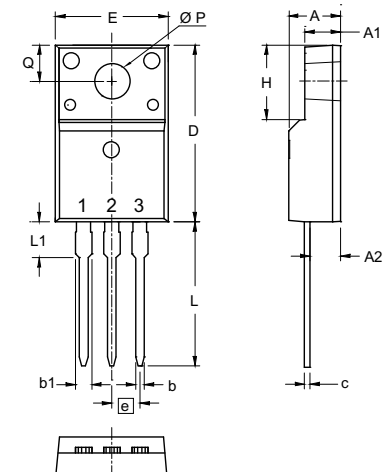

Dim.	Millimeters		Inches	
	min	max	min	max
A	4.50	4.90	0.177	0.193
A1	2.34	2.74	0.092	0.108
A2	2.56	2.96	0.101	0.117
b	0.70	0.90	0.028	0.035
b1	1.27	1.47	0.050	0.058
c	0.45	0.60	0.018	0.024
D	15.67	16.07	0.617	0.633
E	9.96	10.36	0.392	0.408
e	2.54 BSC		0.100 BSC	
H	6.48	6.88	0.255	0.271
L	12.68	13.28	0.499	0.523
L1	3.03	3.43	0.119	0.135
Ø P	3.08	3.28	0.121	0.129
Q	3.20	3.40	0.126	0.134



Dimensions in mm and inches (1 mm = 0.0394")

**X007b TO-220 ACFP** Weight = 2 g

Dim.	Millimeters		Inches	
	min	max	min	max
A	4.50	4.90	0.177	0.193
A1	2.34	2.74	0.092	0.108
A2	2.56	2.96	0.101	0.117
b	0.70	0.90	0.028	0.035
b1	1.27	1.47	0.050	0.058
c	0.45	0.60	0.018	0.024
D	15.67	16.07	0.617	0.633
d1	0.00	1.10	0.000	0.043
E	9.96	10.36	0.392	0.408
e	2.54 BSC		0.100 BSC	
H	6.48	6.88	0.255	0.271
L	12.68	13.28	0.499	0.523
L1	3.03	3.43	0.119	0.135
Ø P	3.08	3.28	0.121	0.129
Q	3.20	3.40	0.126	0.134

**X008a TO-262 I<sup>2</sup>PAK** Weight = 1.5 g

Dim.	Millimeters		Inches	
	min	max	min	max
A	4.30	4.70	0.169	0.185
A1	2.20	2.60	0.087	0.102
b	0.70	0.90	0.028	0.035
b1	1.37	1.57	0.054	0.062
c	0.45	0.60	0.018	0.024
D	9.00	9.40	0.355	0.370
D1	7.20		0.284	
E	9.70	9.90	0.382	0.390
E1	7.00		0.276	
e	2.54 BSC		0.100 BSC	
L	12.88	13.28	0.507	0.523
L1	3.00	-	0.118	-
L2	1.00	1.40	0.039	0.055

**X008b TO-262 I<sup>2</sup>PAK** Weight = 1.5 g

Dim.	Millimeters		Inches	
	min	max	min	max
A	4.06	4.83	0.160	0.190
A2	2.41		0.095	
b	0.51	0.99	0.020	0.039
b2	1.14	1.40	0.045	0.055
c	0.40	0.74	0.016	0.029
D	8.38	9.40	0.330	0.370
D1	8.00	8.89	0.315	0.350
D2	2.5		0.098	
E	9.65	10.41	0.380	0.410
E1	6.22	8.50	0.245	0.335
e	2.54 BSC		0.100 BSC	
e1	4.28		0.169	
L	13.00	13.60	0.512	0.535
L1	2.90	3.10	0.114	0.122
L2	1.02	1.68	0.040	0.066

*All dimensions conform with and/or within JEDEC standard*

**X009a PLUS220™** Weight = 2.5 g

Dim.	Millimeters		Inches	
	min	max	min	max
A	4.30	4.70	0.169	0.185
A1	0.70	0.90	0.028	0.035
A2	2.50	3.00	0.098	0.118
b	0.90	1.20	0.035	0.047
b1	2.03	2.41	0.080	0.095
b2	1.37	1.63	0.054	0.064
c	0.70	0.90	0.028	0.035
D	14.00	15.00	0.551	0.591
D1	13.00	13.70	0.512	0.539
E	10.00	11.00	0.394	0.433
E1	8.40	8.80	0.331	0.346
e	2.54 BSC		0.100 BSC	
L	13.00	14.00	0.512	0.551
L1	3.00	3.50	0.118	0.138
L2	0.90	1.30	0.035	0.051
L3	1.20	1.50	0.047	0.059

**X010a ISOPLUS220™ AB** Weight = 2.5 g

Dim.	Millimeters		Inches	
	min	max	min	max
A	4.00	5.00	0.157	0.197
A1	2.50	3.00	0.098	0.118
A2	1.60	1.80	0.063	0.071
b	0.90	1.30	0.035	0.051
b2	2.35	2.55	0.093	0.100
b4	1.25	1.65	0.049	0.065
c	0.70	1.00	0.028	0.039
D	15.00	16.00	0.591	0.630
D1	12.00	13.00	0.472	0.512
D2	1.10	1.50	0.043	0.059
D3	14.90	15.50	0.587	0.610
E	10.00	11.00	0.394	0.433
E1	7.50	8.50	0.295	0.335
e	2.54 BSC		0.100 BSC	
L	13.00	14.50	0.512	0.571
L1	3.00	3.50	0.118	0.138
T°	42.5	47.5	-	-
W	-	0.10	-	0.004

**X010b ISOPLUS220™ AC** Weight = 2.5 g

Dim.	Millimeters		Inches	
	min	max	min	max
A	4.00	5.00	0.157	0.197
A1	2.50	3.00	0.098	0.118
A2	1.60	1.80	0.063	0.071
b	0.90	1.30	0.035	0.051
b2	1.25	1.65	0.049	0.065
b4	2.35	2.55	0.093	0.100
c	0.70	1.00	0.028	0.039
D	15.00	16.00	0.591	0.630
D1	12.00	13.00	0.472	0.512
D2	1.10	1.50	0.043	0.059
D3	14.90	15.50	0.587	0.610
E	10.00	11.00	0.394	0.433
E1	7.50	8.50	0.295	0.335
e	5.08 BSC		0.200 BSC	
L	13.00	14.50	0.512	0.571
L1	3.00	3.50	0.118	0.138
T°	42.5	47.5	-	-
W	-	0.10	-	0.004

Dimensions in mm and inches (1 mm = 0.0394")

**X011a TO-263 AA (D<sup>2</sup>PAK)** Weight = 1.5 g

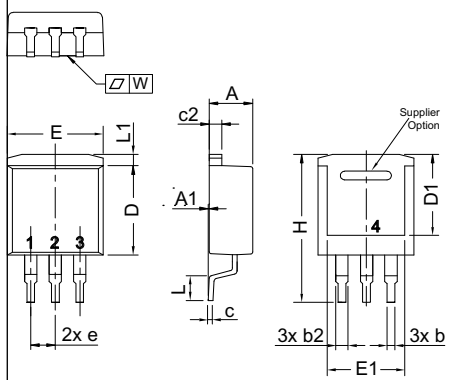

Dim.	Millimeter		Inches	
	min	max	min	max
A	4.06	4.83	0.160	0.190
A1	typ. 0.10		typ. 0.004	
b	0.51	0.99	0.020	0.039
b2	1.14	1.40	0.045	0.055
c	0.40	0.74	0.016	0.029
c2	1.14	1.40	0.045	0.055
D	8.38	9.40	0.330	0.370
D1	8.00	8.89	0.315	0.350
E	9.65	10.41	0.380	0.410
E1	6.22	8.13	0.245	0.320
e	2,54 BSC		0,100 BSC	
H	14.61	15.88	0.575	0.625
L	1.78	2.79	0.070	0.110
L1	1.02	1.68	0.040	0.066
W	typ. 0.02	0.040	typ. 0.0008	0.002

**X011b TO-263 AB (D<sup>2</sup>PAK)** Weight = 1.5 g

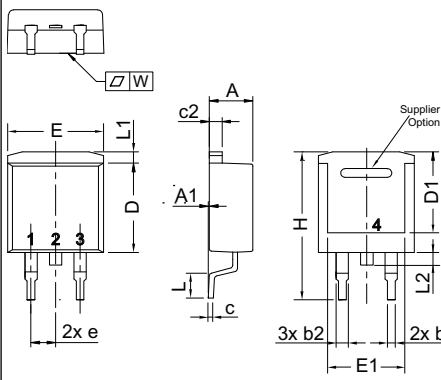

Dim.	Millimeter		Inches	
	min	max	min	max
A	4.06	4.83	0.160	0.190
A1	typ. 0.10		typ. 0.004	
b	0.51	0.99	0.020	0.039
b2	1.14	1.40	0.045	0.055
c	0.40	0.74	0.016	0.029
c2	1.14	1.40	0.045	0.055
D	8.38	9.40	0.330	0.370
D1	8.00	8.89	0.315	0.350
E	9.65	10.41	0.380	0.410
E1	6.22	8.13	0.245	0.320
e	2,54 BSC		0,100 BSC	
H	14.61	15.88	0.575	0.625
L	1.78	2.79	0.070	0.110
L1	1.02	1.68	0.040	0.066
W	typ. 0.02	0.040	typ. 0.0008	0.002

**X011c TO-263 AB (D<sup>2</sup>PAK)** Weight = ?? g

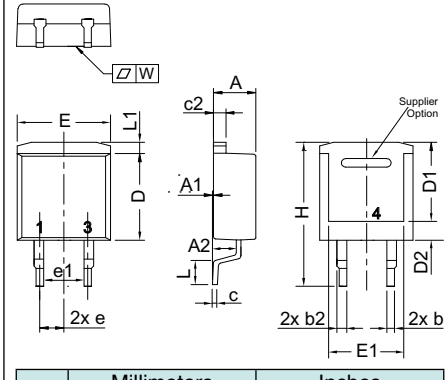

Dim.	Millimeters		Inches	
	min	max	min	max
A	4.06	4.83	0.160	0.190
A1	typ 0.10		typ 0.004	
A2	2.41		0.095	
b	0.51	0.99	0.020	0.039
b2	1.14	1.40	0.045	0.055
c	0.40	0.74	0.016	0.029
c2	1.14	1.40	0.045	0.055
D	8.38	9.40	0.330	0.370
D1	8.00	8.89	0.315	0.350
D2	2.5		0.098	
E	9.65	10.41	0.380	0.410
E1	6.22	8.50	0.245	0.335
e	2.54 BSC		0.100 BSC	
e1	4.28		0.169	
H	14.61	15.88	0.575	0.625
L	1.78	2.79	0.070	0.110
L2	1.02	1.68	0.040	0.066
W	typ 0.02	0.040	typ 0.0008	0.002

All dimensions conform with and/or within JEDEC standard

**X012a TO-263 (5)** Weight = 1.5 g

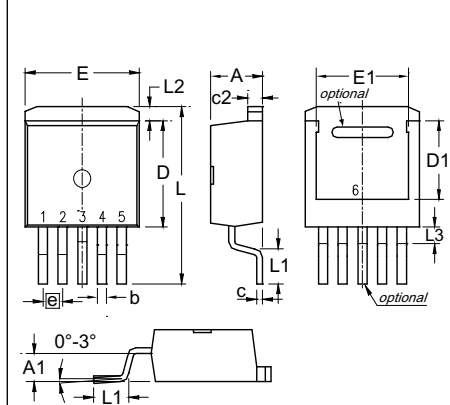

Dim.	Millimeter		Inches	
	min	max	min	max
A	4.20	4.80	0.160	0.190
A1	2.10	2.70	0.083	0.106
b	0.60	0.99	0.024	0.039
c	0.40	0.70	0.016	0.028
c2	1.20	1.40	0.047	0.055
D	8.80	9.50	0.346	0.374
D1	6.60	7.20	0.260	0.283
E	9.65	10.30	0.380	0.406
E1	7.50	8.20	0.295	0.323
e	1.70 BSC		0.067 BSC	
L	14.80	15.80	0.583	0.622
L1	2.24	2.84	0.088	0.112
L2	1.00	1.40	0.039	0.067
L3	1.20	1.70	0.047	0.067

**X012b TO-263 (7)  
c) middle leg cut** Weight = 2.5 g

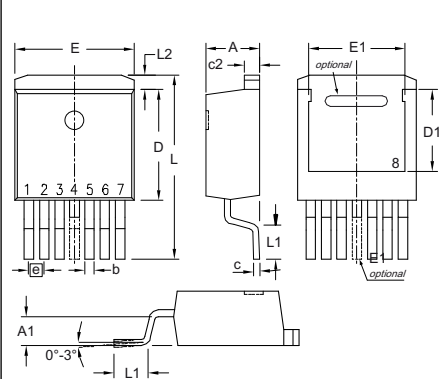

Dim.	Millimeter		Inches	
	min	max	min	max
A	4.20	4.60	0.165	0.181
A1	2.45	2.75	0.096	0.108
b	0.65	0.90	0.026	0.035
c	0.40	0.60	0.016	0.024
c2	1.14	1.40	0.045	0.055
D	8.38	8.64	0.330	0.340
D1	6.10	6.35	0.240	0.250
E	10.00	10.30	0.394	0.406
E1	7.34	8.00	0.290	0.315
e	1.27 BSC		0.050 BSC	
L	14.73	15.75	0.580	0.620
L1	2.24	2.84	0.088	0.112
L2	1.35	1.55	0.053	0.061

**X013 PLUS220™ (SMD)** Weight = 2 g

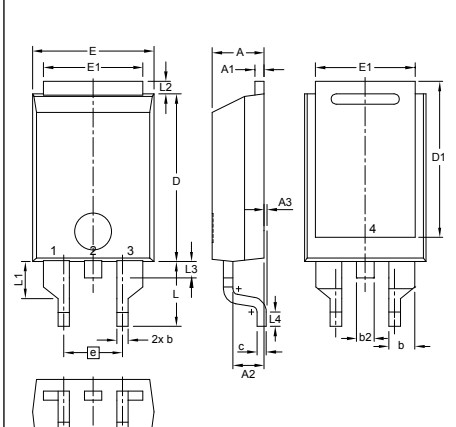

Dim.	Millimeter		Inches	
	min	max	min	max
A	4.30	4.70	0.169	0.185
A1	0.70	0.90	0.028	0.035
A2	2.50	3.00	0.098	0.118
A3	0.00	0.25	0.000	0.010
b	0.90	1.20	0.035	0.047
b1	2.03	2.41	0.080	0.095
b2	1.37	1.63	0.054	0.064
c	0.70	0.90	0.028	0.035
D	14.00	15.00	0.551	0.591
D1	13.00	13.70	0.512	0.539
E	10.00	11.00	0.394	0.433
E1	8.40	8.80	0.331	0.346
e	5.08 BSC		0.200 BSC	
L	5.30	5.80	0.209	0.228
L1	3.00	3.50	0.118	0.138
L2	0.90	1.30	0.035	0.051
L3	1.20	1.50	0.047	0.059
L4	1.00	1.50	0.039	0.059

Dimensions in mm and inches (1 mm = 0.0394")

<p><b>X014a TO-247 AD</b> Weight = 6 g</p> <table border="1"> <thead> <tr> <th rowspan="2">Dim.</th> <th colspan="2">Millimeter</th> <th colspan="2">Inches</th> </tr> <tr> <th>min</th> <th>max</th> <th>min</th> <th>max</th> </tr> </thead> <tbody> <tr><td>A</td><td>4.70</td><td>5.30</td><td>0.185</td><td>0.209</td></tr> <tr><td>A1</td><td>2.21</td><td>2.59</td><td>0.087</td><td>0.102</td></tr> <tr><td>A2</td><td>1.50</td><td>2.49</td><td>0.059</td><td>0.098</td></tr> <tr><td>b</td><td>0.99</td><td>1.40</td><td>0.039</td><td>0.055</td></tr> <tr><td>b2</td><td>1.65</td><td>2.39</td><td>0.065</td><td>0.094</td></tr> <tr><td>b4</td><td>2.59</td><td>3.43</td><td>0.102</td><td>0.135</td></tr> <tr><td>c</td><td>0.38</td><td>0.89</td><td>0.015</td><td>0.035</td></tr> <tr><td>D</td><td>20.79</td><td>21.45</td><td>0.819</td><td>0.845</td></tr> <tr><td>D1</td><td>13.07</td><td>-</td><td>0.515</td><td>-</td></tr> <tr><td>D2</td><td>0.51</td><td>1.35</td><td>0.020</td><td>0.053</td></tr> <tr><td>E</td><td>15.48</td><td>16.24</td><td>0.610</td><td>0.640</td></tr> <tr><td>E1</td><td>13.45</td><td>-</td><td>0.53</td><td>-</td></tr> <tr><td>E2</td><td>4.31</td><td>5.48</td><td>0.170</td><td>0.216</td></tr> <tr><td>e</td><td colspan="2">5.45 BSC</td><td colspan="2">0.215 BSC</td></tr> <tr><td>L</td><td>19.80</td><td>20.30</td><td>0.078</td><td>0.800</td></tr> <tr><td>L1</td><td>-</td><td>4.49</td><td>-</td><td>0.177</td></tr> <tr><td>Ø P</td><td>3.55</td><td>3.65</td><td>0.140</td><td>0.144</td></tr> <tr><td>Ø P1</td><td>-</td><td>7.39</td><td>-</td><td>0.290</td></tr> <tr><td>Q</td><td>5.38</td><td>6.19</td><td>0.212</td><td>0.244</td></tr> <tr><td>S</td><td colspan="2">6.14 BSC</td><td colspan="2">0.242 BSC</td></tr> </tbody> </table>	Dim.	Millimeter		Inches		min	max	min	max	A	4.70	5.30	0.185	0.209	A1	2.21	2.59	0.087	0.102	A2	1.50	2.49	0.059	0.098	b	0.99	1.40	0.039	0.055	b2	1.65	2.39	0.065	0.094	b4	2.59	3.43	0.102	0.135	c	0.38	0.89	0.015	0.035	D	20.79	21.45	0.819	0.845	D1	13.07	-	0.515	-	D2	0.51	1.35	0.020	0.053	E	15.48	16.24	0.610	0.640	E1	13.45	-	0.53	-	E2	4.31	5.48	0.170	0.216	e	5.45 BSC		0.215 BSC		L	19.80	20.30	0.078	0.800	L1	-	4.49	-	0.177	Ø P	3.55	3.65	0.140	0.144	Ø P1	-	7.39	-	0.290	Q	5.38	6.19	0.212	0.244	S	6.14 BSC		0.242 BSC		<p><b>X014b TO-247 AD</b> Weight = 6 g</p> <table border="1"> <thead> <tr> <th rowspan="2">Dim.</th> <th colspan="2">Millimeter</th> <th colspan="2">Inches</th> </tr> <tr> <th>min</th> <th>max</th> <th>min</th> <th>max</th> </tr> </thead> <tbody> <tr><td>A</td><td>4.70</td><td>5.30</td><td>0.185</td><td>0.209</td></tr> <tr><td>A1</td><td>2.21</td><td>2.59</td><td>0.087</td><td>0.102</td></tr> <tr><td>A2</td><td>1.50</td><td>2.49</td><td>0.059</td><td>0.098</td></tr> <tr><td>b</td><td>0.99</td><td>1.40</td><td>0.039</td><td>0.055</td></tr> <tr><td>b2</td><td>1.65</td><td>2.39</td><td>0.065</td><td>0.094</td></tr> <tr><td>b4</td><td>2.59</td><td>3.43</td><td>0.102</td><td>0.135</td></tr> <tr><td>c</td><td>0.38</td><td>0.89</td><td>0.015</td><td>0.035</td></tr> <tr><td>D</td><td>20.79</td><td>21.45</td><td>0.819</td><td>0.845</td></tr> <tr><td>D1</td><td>13.07</td><td>-</td><td>0.515</td><td>-</td></tr> <tr><td>D2</td><td>0.51</td><td>1.35</td><td>0.020</td><td>0.053</td></tr> <tr><td>E</td><td>15.48</td><td>16.24</td><td>0.610</td><td>0.640</td></tr> <tr><td>E1</td><td>13.45</td><td>-</td><td>0.530</td><td>-</td></tr> <tr><td>E2</td><td>4.31</td><td>5.48</td><td>0.170</td><td>0.216</td></tr> <tr><td>e</td><td colspan="2">10.90 BSC</td><td colspan="2">0.430 BSC</td></tr> <tr><td>L</td><td>19.80</td><td>20.30</td><td>0.078</td><td>0.800</td></tr> <tr><td>L1</td><td>-</td><td>4.49</td><td>-</td><td>0.177</td></tr> <tr><td>Ø P</td><td>3.55</td><td>3.65</td><td>0.140</td><td>0.144</td></tr> <tr><td>Ø P1</td><td>-</td><td>7.39</td><td>-</td><td>0.290</td></tr> <tr><td>Q</td><td>5.38</td><td>6.19</td><td>0.212</td><td>0.244</td></tr> <tr><td>S</td><td colspan="2">6.14 BSC</td><td colspan="2">0.242 BSC</td></tr> </tbody> </table>	Dim.	Millimeter		Inches		min	max	min	max	A	4.70	5.30	0.185	0.209	A1	2.21	2.59	0.087	0.102	A2	1.50	2.49	0.059	0.098	b	0.99	1.40	0.039	0.055	b2	1.65	2.39	0.065	0.094	b4	2.59	3.43	0.102	0.135	c	0.38	0.89	0.015	0.035	D	20.79	21.45	0.819	0.845	D1	13.07	-	0.515	-	D2	0.51	1.35	0.020	0.053	E	15.48	16.24	0.610	0.640	E1	13.45	-	0.530	-	E2	4.31	5.48	0.170	0.216	e	10.90 BSC		0.430 BSC		L	19.80	20.30	0.078	0.800	L1	-	4.49	-	0.177	Ø P	3.55	3.65	0.140	0.144	Ø P1	-	7.39	-	0.290	Q	5.38	6.19	0.212	0.244	S	6.14 BSC		0.242 BSC		<p><b>X015a PLUS247™</b> Weight = 7 g</p> <table border="1"> <thead> <tr> <th rowspan="2">Dim.</th> <th colspan="2">Millimeter</th> <th colspan="2">Inches</th> </tr> <tr> <th>min</th> <th>max</th> <th>min</th> <th>max</th> </tr> </thead> <tbody> <tr><td>A</td><td>4.83</td><td>5.21</td><td>0.190</td><td>0.205</td></tr> <tr><td>A1</td><td>2.29</td><td>2.54</td><td>0.090</td><td>0.100</td></tr> <tr><td>A2</td><td>1.91</td><td>2.16</td><td>0.075</td><td>0.085</td></tr> <tr><td>b</td><td>1.14</td><td>1.40</td><td>0.045</td><td>0.055</td></tr> <tr><td>b1</td><td>1.90</td><td>2.10</td><td>0.075</td><td>0.084</td></tr> <tr><td>b2</td><td>2.92</td><td>3.12</td><td>0.115</td><td>0.123</td></tr> <tr><td>C</td><td>0.60</td><td>0.80</td><td>0.024</td><td>0.031</td></tr> <tr><td>D</td><td>20.80</td><td>21.34</td><td>0.819</td><td>0.840</td></tr> <tr><td>E</td><td>15.75</td><td>16.13</td><td>0.620</td><td>0.635</td></tr> <tr><td>e</td><td colspan="2">5.45 BSC</td><td colspan="2">0.215 BSC</td></tr> <tr><td>L</td><td>19.80</td><td>20.30</td><td>0.078</td><td>0.800</td></tr> <tr><td>L1</td><td>3.80</td><td>4.30</td><td>0.150</td><td>0.170</td></tr> <tr><td>Q</td><td>5.60</td><td>6.20</td><td>0.220</td><td>0.244</td></tr> <tr><td>R</td><td>4.32</td><td>4.83</td><td>0.170</td><td>0.190</td></tr> </tbody> </table>	Dim.	Millimeter		Inches		min	max	min	max	A	4.83	5.21	0.190	0.205	A1	2.29	2.54	0.090	0.100	A2	1.91	2.16	0.075	0.085	b	1.14	1.40	0.045	0.055	b1	1.90	2.10	0.075	0.084	b2	2.92	3.12	0.115	0.123	C	0.60	0.80	0.024	0.031	D	20.80	21.34	0.819	0.840	E	15.75	16.13	0.620	0.635	e	5.45 BSC		0.215 BSC		L	19.80	20.30	0.078	0.800	L1	3.80	4.30	0.150	0.170	Q	5.60	6.20	0.220	0.244	R	4.32	4.83	0.170	0.190
Dim.		Millimeter		Inches																																																																																																																																																																																																																																																																																																							
	min	max	min	max																																																																																																																																																																																																																																																																																																							
A	4.70	5.30	0.185	0.209																																																																																																																																																																																																																																																																																																							
A1	2.21	2.59	0.087	0.102																																																																																																																																																																																																																																																																																																							
A2	1.50	2.49	0.059	0.098																																																																																																																																																																																																																																																																																																							
b	0.99	1.40	0.039	0.055																																																																																																																																																																																																																																																																																																							
b2	1.65	2.39	0.065	0.094																																																																																																																																																																																																																																																																																																							
b4	2.59	3.43	0.102	0.135																																																																																																																																																																																																																																																																																																							
c	0.38	0.89	0.015	0.035																																																																																																																																																																																																																																																																																																							
D	20.79	21.45	0.819	0.845																																																																																																																																																																																																																																																																																																							
D1	13.07	-	0.515	-																																																																																																																																																																																																																																																																																																							
D2	0.51	1.35	0.020	0.053																																																																																																																																																																																																																																																																																																							
E	15.48	16.24	0.610	0.640																																																																																																																																																																																																																																																																																																							
E1	13.45	-	0.53	-																																																																																																																																																																																																																																																																																																							
E2	4.31	5.48	0.170	0.216																																																																																																																																																																																																																																																																																																							
e	5.45 BSC		0.215 BSC																																																																																																																																																																																																																																																																																																								
L	19.80	20.30	0.078	0.800																																																																																																																																																																																																																																																																																																							
L1	-	4.49	-	0.177																																																																																																																																																																																																																																																																																																							
Ø P	3.55	3.65	0.140	0.144																																																																																																																																																																																																																																																																																																							
Ø P1	-	7.39	-	0.290																																																																																																																																																																																																																																																																																																							
Q	5.38	6.19	0.212	0.244																																																																																																																																																																																																																																																																																																							
S	6.14 BSC		0.242 BSC																																																																																																																																																																																																																																																																																																								
Dim.	Millimeter		Inches																																																																																																																																																																																																																																																																																																								
	min	max	min	max																																																																																																																																																																																																																																																																																																							
A	4.70	5.30	0.185	0.209																																																																																																																																																																																																																																																																																																							
A1	2.21	2.59	0.087	0.102																																																																																																																																																																																																																																																																																																							
A2	1.50	2.49	0.059	0.098																																																																																																																																																																																																																																																																																																							
b	0.99	1.40	0.039	0.055																																																																																																																																																																																																																																																																																																							
b2	1.65	2.39	0.065	0.094																																																																																																																																																																																																																																																																																																							
b4	2.59	3.43	0.102	0.135																																																																																																																																																																																																																																																																																																							
c	0.38	0.89	0.015	0.035																																																																																																																																																																																																																																																																																																							
D	20.79	21.45	0.819	0.845																																																																																																																																																																																																																																																																																																							
D1	13.07	-	0.515	-																																																																																																																																																																																																																																																																																																							
D2	0.51	1.35	0.020	0.053																																																																																																																																																																																																																																																																																																							
E	15.48	16.24	0.610	0.640																																																																																																																																																																																																																																																																																																							
E1	13.45	-	0.530	-																																																																																																																																																																																																																																																																																																							
E2	4.31	5.48	0.170	0.216																																																																																																																																																																																																																																																																																																							
e	10.90 BSC		0.430 BSC																																																																																																																																																																																																																																																																																																								
L	19.80	20.30	0.078	0.800																																																																																																																																																																																																																																																																																																							
L1	-	4.49	-	0.177																																																																																																																																																																																																																																																																																																							
Ø P	3.55	3.65	0.140	0.144																																																																																																																																																																																																																																																																																																							
Ø P1	-	7.39	-	0.290																																																																																																																																																																																																																																																																																																							
Q	5.38	6.19	0.212	0.244																																																																																																																																																																																																																																																																																																							
S	6.14 BSC		0.242 BSC																																																																																																																																																																																																																																																																																																								
Dim.	Millimeter		Inches																																																																																																																																																																																																																																																																																																								
	min	max	min	max																																																																																																																																																																																																																																																																																																							
A	4.83	5.21	0.190	0.205																																																																																																																																																																																																																																																																																																							
A1	2.29	2.54	0.090	0.100																																																																																																																																																																																																																																																																																																							
A2	1.91	2.16	0.075	0.085																																																																																																																																																																																																																																																																																																							
b	1.14	1.40	0.045	0.055																																																																																																																																																																																																																																																																																																							
b1	1.90	2.10	0.075	0.084																																																																																																																																																																																																																																																																																																							
b2	2.92	3.12	0.115	0.123																																																																																																																																																																																																																																																																																																							
C	0.60	0.80	0.024	0.031																																																																																																																																																																																																																																																																																																							
D	20.80	21.34	0.819	0.840																																																																																																																																																																																																																																																																																																							
E	15.75	16.13	0.620	0.635																																																																																																																																																																																																																																																																																																							
e	5.45 BSC		0.215 BSC																																																																																																																																																																																																																																																																																																								
L	19.80	20.30	0.078	0.800																																																																																																																																																																																																																																																																																																							
L1	3.80	4.30	0.150	0.170																																																																																																																																																																																																																																																																																																							
Q	5.60	6.20	0.220	0.244																																																																																																																																																																																																																																																																																																							
R	4.32	4.83	0.170	0.190																																																																																																																																																																																																																																																																																																							
<p><b>X016a ISOPLUS247™</b> Weight = 4.5 g</p> <table border="1"> <thead> <tr> <th rowspan="2">Dim.</th> <th colspan="2">Millimeter</th> <th colspan="2">Inches</th> </tr> <tr> <th>min</th> <th>max</th> <th>min</th> <th>max</th> </tr> </thead> <tbody> <tr><td>A</td><td>4.83</td><td>5.21</td><td>0.190</td><td>0.205</td></tr> <tr><td>A1</td><td>2.29</td><td>2.54</td><td>0.090</td><td>0.100</td></tr> <tr><td>A2</td><td>1.91</td><td>2.16</td><td>0.075</td><td>0.085</td></tr> <tr><td>b</td><td>1.14</td><td>1.40</td><td>0.045</td><td>0.055</td></tr> <tr><td>b2</td><td>1.91</td><td>2.20</td><td>0.075</td><td>0.087</td></tr> <tr><td>b4</td><td>2.92</td><td>3.24</td><td>0.115</td><td>0.128</td></tr> <tr><td>c</td><td>0.61</td><td>0.83</td><td>0.024</td><td>0.033</td></tr> <tr><td>D</td><td>20.80</td><td>21.34</td><td>0.819</td><td>0.840</td></tr> <tr><td>D1</td><td>15.75</td><td>16.26</td><td>0.620</td><td>0.640</td></tr> <tr><td>D2</td><td>1.65</td><td>2.15</td><td>0.065</td><td>0.085</td></tr> <tr><td>D3</td><td>20.30</td><td>20.70</td><td>0.799</td><td>0.815</td></tr> <tr><td>E</td><td>15.75</td><td>16.13</td><td>0.620</td><td>0.635</td></tr> <tr><td>E1</td><td>13.21</td><td>13.72</td><td>0.520</td><td>0.540</td></tr> <tr><td>e</td><td colspan="2">5.45 BSC</td><td colspan="2">0.215 BSC</td></tr> <tr><td>L</td><td>19.81</td><td>20.60</td><td>0.780</td><td>0.811</td></tr> <tr><td>L1</td><td>3.81</td><td>4.38</td><td>0.150</td><td>0.172</td></tr> <tr><td>Q</td><td>5.59</td><td>6.20</td><td>0.220</td><td>0.244</td></tr> <tr><td>R</td><td>4.25</td><td>5.50</td><td>0.167</td><td>0.217</td></tr> <tr><td>W</td><td>-</td><td>0.10</td><td>-</td><td>0.004</td></tr> </tbody> </table>	Dim.	Millimeter		Inches		min	max	min	max	A	4.83	5.21	0.190	0.205	A1	2.29	2.54	0.090	0.100	A2	1.91	2.16	0.075	0.085	b	1.14	1.40	0.045	0.055	b2	1.91	2.20	0.075	0.087	b4	2.92	3.24	0.115	0.128	c	0.61	0.83	0.024	0.033	D	20.80	21.34	0.819	0.840	D1	15.75	16.26	0.620	0.640	D2	1.65	2.15	0.065	0.085	D3	20.30	20.70	0.799	0.815	E	15.75	16.13	0.620	0.635	E1	13.21	13.72	0.520	0.540	e	5.45 BSC		0.215 BSC		L	19.81	20.60	0.780	0.811	L1	3.81	4.38	0.150	0.172	Q	5.59	6.20	0.220	0.244	R	4.25	5.50	0.167	0.217	W	-	0.10	-	0.004	<p><b>X016b ISOPLUS247™</b> Weight = 4.5 g</p> <table border="1"> <thead> <tr> <th rowspan="2">Dim.</th> <th colspan="2">Millimeter</th> <th colspan="2">Inches</th> </tr> <tr> <th>min</th> <th>max</th> <th>min</th> <th>max</th> </tr> </thead> <tbody> <tr><td>A</td><td>4.83</td><td>5.21</td><td>0.190</td><td>0.205</td></tr> <tr><td>A1</td><td>2.29</td><td>2.54</td><td>0.090</td><td>0.100</td></tr> <tr><td>A2</td><td>1.91</td><td>2.16</td><td>0.075</td><td>0.085</td></tr> <tr><td>b</td><td>1.14</td><td>1.40</td><td>0.045</td><td>0.055</td></tr> <tr><td>b2</td><td>1.91</td><td>2.20</td><td>0.075</td><td>0.087</td></tr> <tr><td>b4</td><td>2.92</td><td>3.24</td><td>0.115</td><td>0.128</td></tr> <tr><td>c</td><td>0.61</td><td>0.83</td><td>0.024</td><td>0.033</td></tr> <tr><td>D</td><td>20.80</td><td>21.34</td><td>0.819</td><td>0.840</td></tr> <tr><td>D1</td><td>15.75</td><td>16.26</td><td>0.620</td><td>0.640</td></tr> <tr><td>D2</td><td>1.65</td><td>2.15</td><td>0.065</td><td>0.085</td></tr> <tr><td>D3</td><td>20.30</td><td>20.70</td><td>0.799</td><td>0.815</td></tr> <tr><td>E</td><td>15.75</td><td>16.13</td><td>0.620</td><td>0.635</td></tr> <tr><td>E1</td><td>13.21</td><td>13.72</td><td>0.520</td><td>0.540</td></tr> <tr><td>e</td><td colspan="2">10.90 BSC</td><td colspan="2">0.430 BSC</td></tr> <tr><td>L</td><td>19.81</td><td>20.60</td><td>0.780</td><td>0.811</td></tr> <tr><td>L1</td><td>3.81</td><td>4.38</td><td>0.150</td><td>0.172</td></tr> <tr><td>Q</td><td>5.59</td><td>6.20</td><td>0.220</td><td>0.244</td></tr> <tr><td>R</td><td>4.25</td><td>5.50</td><td>0.167</td><td>0.217</td></tr> <tr><td>W</td><td>-</td><td>0.10</td><td>-</td><td>0.004</td></tr> </tbody> </table>	Dim.	Millimeter		Inches		min	max	min	max	A	4.83	5.21	0.190	0.205	A1	2.29	2.54	0.090	0.100	A2	1.91	2.16	0.075	0.085	b	1.14	1.40	0.045	0.055	b2	1.91	2.20	0.075	0.087	b4	2.92	3.24	0.115	0.128	c	0.61	0.83	0.024	0.033	D	20.80	21.34	0.819	0.840	D1	15.75	16.26	0.620	0.640	D2	1.65	2.15	0.065	0.085	D3	20.30	20.70	0.799	0.815	E	15.75	16.13	0.620	0.635	E1	13.21	13.72	0.520	0.540	e	10.90 BSC		0.430 BSC		L	19.81	20.60	0.780	0.811	L1	3.81	4.38	0.150	0.172	Q	5.59	6.20	0.220	0.244	R	4.25	5.50	0.167	0.217	W	-	0.10	-	0.004	<p><b>X016c ISO247™</b> Weight = 4.5 g</p> <table border="1"> <thead> <tr> <th rowspan="2">Dim.</th> <th colspan="2">Millimeter</th> <th colspan="2">Inches</th> </tr> <tr> <th>min</th> <th>max</th> <th>min</th> <th>max</th> </tr> </thead> <tbody> <tr><td>A</td><td>4.70</td><td>5.30</td><td>0.185</td><td>0.209</td></tr> <tr><td>A1</td><td>2.21</td><td>2.59</td><td>0.087</td><td>0.102</td></tr> <tr><td>A2</td><td>1.50</td><td>2.49</td><td>0.059</td><td>0.098</td></tr> <tr><td>b</td><td>0.99</td><td>1.40</td><td>0.039</td><td>0.055</td></tr> <tr><td>b2</td><td>1.65</td><td>2.39</td><td>0.065</td><td>0.094</td></tr> <tr><td>b4</td><td>2.59</td><td>3.43</td><td>0.102</td><td>0.135</td></tr> <tr><td>c</td><td>0.38</td><td>0.89</td><td>0.015</td><td>0.035</td></tr> <tr><td>D</td><td>20.79</td><td>21.45</td><td>0.819</td><td>0.844</td></tr> <tr><td>E</td><td>15.49</td><td>16.24</td><td>0.610</td><td>0.639</td></tr> <tr><td>E2</td><td>4.31</td><td>5.48</td><td>0.170</td><td>0.216</td></tr> <tr><td>e</td><td colspan="2">5.46 BSC</td><td colspan="2">0.215 BSC</td></tr> <tr><td>L</td><td>19.80</td><td>20.30</td><td>0.780</td><td>0.799</td></tr> <tr><td>L1</td><td>-</td><td>4.49</td><td>-</td><td>0.177</td></tr> <tr><td>Ø P</td><td>3.55</td><td>3.65</td><td>0.140</td><td>0.144</td></tr> <tr><td>Q</td><td>5.38</td><td>6.19</td><td>0.212</td><td>0.244</td></tr> </tbody> </table>	Dim.	Millimeter		Inches		min	max	min	max	A	4.70	5.30	0.185	0.209	A1	2.21	2.59	0.087	0.102	A2	1.50	2.49	0.059	0.098	b	0.99	1.40	0.039	0.055	b2	1.65	2.39	0.065	0.094	b4	2.59	3.43	0.102	0.135	c	0.38	0.89	0.015	0.035	D	20.79	21.45	0.819	0.844	E	15.49	16.24	0.610	0.639	E2	4.31	5.48	0.170	0.216	e	5.46 BSC		0.215 BSC		L	19.80	20.30	0.780	0.799	L1	-	4.49	-	0.177	Ø P	3.55	3.65	0.140	0.144	Q	5.38	6.19	0.212	0.244					
Dim.		Millimeter		Inches																																																																																																																																																																																																																																																																																																							
	min	max	min	max																																																																																																																																																																																																																																																																																																							
A	4.83	5.21	0.190	0.205																																																																																																																																																																																																																																																																																																							
A1	2.29	2.54	0.090	0.100																																																																																																																																																																																																																																																																																																							
A2	1.91	2.16	0.075	0.085																																																																																																																																																																																																																																																																																																							
b	1.14	1.40	0.045	0.055																																																																																																																																																																																																																																																																																																							
b2	1.91	2.20	0.075	0.087																																																																																																																																																																																																																																																																																																							
b4	2.92	3.24	0.115	0.128																																																																																																																																																																																																																																																																																																							
c	0.61	0.83	0.024	0.033																																																																																																																																																																																																																																																																																																							
D	20.80	21.34	0.819	0.840																																																																																																																																																																																																																																																																																																							
D1	15.75	16.26	0.620	0.640																																																																																																																																																																																																																																																																																																							
D2	1.65	2.15	0.065	0.085																																																																																																																																																																																																																																																																																																							
D3	20.30	20.70	0.799	0.815																																																																																																																																																																																																																																																																																																							
E	15.75	16.13	0.620	0.635																																																																																																																																																																																																																																																																																																							
E1	13.21	13.72	0.520	0.540																																																																																																																																																																																																																																																																																																							
e	5.45 BSC		0.215 BSC																																																																																																																																																																																																																																																																																																								
L	19.81	20.60	0.780	0.811																																																																																																																																																																																																																																																																																																							
L1	3.81	4.38	0.150	0.172																																																																																																																																																																																																																																																																																																							
Q	5.59	6.20	0.220	0.244																																																																																																																																																																																																																																																																																																							
R	4.25	5.50	0.167	0.217																																																																																																																																																																																																																																																																																																							
W	-	0.10	-	0.004																																																																																																																																																																																																																																																																																																							
Dim.	Millimeter		Inches																																																																																																																																																																																																																																																																																																								
	min	max	min	max																																																																																																																																																																																																																																																																																																							
A	4.83	5.21	0.190	0.205																																																																																																																																																																																																																																																																																																							
A1	2.29	2.54	0.090	0.100																																																																																																																																																																																																																																																																																																							
A2	1.91	2.16	0.075	0.085																																																																																																																																																																																																																																																																																																							
b	1.14	1.40	0.045	0.055																																																																																																																																																																																																																																																																																																							
b2	1.91	2.20	0.075	0.087																																																																																																																																																																																																																																																																																																							
b4	2.92	3.24	0.115	0.128																																																																																																																																																																																																																																																																																																							
c	0.61	0.83	0.024	0.033																																																																																																																																																																																																																																																																																																							
D	20.80	21.34	0.819	0.840																																																																																																																																																																																																																																																																																																							
D1	15.75	16.26	0.620	0.640																																																																																																																																																																																																																																																																																																							
D2	1.65	2.15	0.065	0.085																																																																																																																																																																																																																																																																																																							
D3	20.30	20.70	0.799	0.815																																																																																																																																																																																																																																																																																																							
E	15.75	16.13	0.620	0.635																																																																																																																																																																																																																																																																																																							
E1	13.21	13.72	0.520	0.540																																																																																																																																																																																																																																																																																																							
e	10.90 BSC		0.430 BSC																																																																																																																																																																																																																																																																																																								
L	19.81	20.60	0.780	0.811																																																																																																																																																																																																																																																																																																							
L1	3.81	4.38	0.150	0.172																																																																																																																																																																																																																																																																																																							
Q	5.59	6.20	0.220	0.244																																																																																																																																																																																																																																																																																																							
R	4.25	5.50	0.167	0.217																																																																																																																																																																																																																																																																																																							
W	-	0.10	-	0.004																																																																																																																																																																																																																																																																																																							
Dim.	Millimeter		Inches																																																																																																																																																																																																																																																																																																								
	min	max	min	max																																																																																																																																																																																																																																																																																																							
A	4.70	5.30	0.185	0.209																																																																																																																																																																																																																																																																																																							
A1	2.21	2.59	0.087	0.102																																																																																																																																																																																																																																																																																																							
A2	1.50	2.49	0.059	0.098																																																																																																																																																																																																																																																																																																							
b	0.99	1.40	0.039	0.055																																																																																																																																																																																																																																																																																																							
b2	1.65	2.39	0.065	0.094																																																																																																																																																																																																																																																																																																							
b4	2.59	3.43	0.102	0.135																																																																																																																																																																																																																																																																																																							
c	0.38	0.89	0.015	0.035																																																																																																																																																																																																																																																																																																							
D	20.79	21.45	0.819	0.844																																																																																																																																																																																																																																																																																																							
E	15.49	16.24	0.610	0.639																																																																																																																																																																																																																																																																																																							
E2	4.31	5.48	0.170	0.216																																																																																																																																																																																																																																																																																																							
e	5.46 BSC		0.215 BSC																																																																																																																																																																																																																																																																																																								
L	19.80	20.30	0.780	0.799																																																																																																																																																																																																																																																																																																							
L1	-	4.49	-	0.177																																																																																																																																																																																																																																																																																																							
Ø P	3.55	3.65	0.140	0.144																																																																																																																																																																																																																																																																																																							
Q	5.38	6.19	0.212	0.244																																																																																																																																																																																																																																																																																																							

Dimensions in mm and inches (1 mm = 0.0394")

**X016d ISO247™** Weight = 4 g

Dim.	Millimeter		Inches	
	min	max	min	max
A	19.81	20.32	0.780	0.800
B	20.80	21.46	0.819	0.845
C	15.75	16.26	0.610	0.640
D	3.55	3.65	0.140	0.144
E	4.32	5.49	0.170	0.216
F	5.40	6.20	0.212	0.244
G	1.65	2.13	0.065	0.084
H	-	4.50	-	0.177
J	1.00	1.40	0.040	0.055
K	10.80	11.00	0.426	0.433
L	4.70	5.30	0.185	0.209
M	0.40	0.80	0.016	0.031
N	1.50	2.49	0.087	0.102

**X017a TO-3P** Weight = 5.5 g

Dim.	Millimeter		Inches	
	min	max	min	max
A	4.70	4.90	0.185	0.193
A1	1.30	1.50	0.051	0.059
A2	1.45	1.65	0.057	0.065
b	0.90	1.15	0.035	0.045
b2	1.90	2.20	0.075	0.087
b4	2.90	3.20	0.114	0.126
c	0.55	0.80	0.022	0.031
D	19.80	20.10	0.780	0.791
D1	16.90	17.20	0.665	0.677
E	15.50	15.80	0.610	0.622
E1	13.50	13.70	0.531	0.539
e	5.45 BSC		0.215 BSC	
L	19.80	20.20	0.780	0.795
L1	3.40	3.60	0.134	0.142
Ø P	3.20	3.40	0.126	0.134
Ø P1	6.90	7.10	0.272	0.280
S	4.90	5.10	0.193	0.201

All metal area are tin plated.

**X017b TO-3P** Weight = 5.5 g

Dim.	Millimeter		Inches	
	min	max	min	max
A	4.70	4.90	0.185	0.193
A1	1.30	1.50	0.051	0.059
A2	1.45	1.65	0.057	0.065
b	0.90	1.15	0.035	0.045
b2	1.90	2.20	0.075	0.087
b4	2.90	3.20	0.114	0.126
c	0.55	0.80	0.022	0.031
D	19.80	20.10	0.780	0.791
D1	16.90	17.20	0.665	0.677
E	15.50	15.80	0.610	0.622
E1	13.50	13.70	0.531	0.539
e	5.45 BSC		0.215 BSC	
L	19.80	20.20	0.780	0.795
L1	3.40	3.60	0.134	0.142
L2	0.00	1.40	0.000	0.055
Ø P	3.20	3.40	0.126	0.134
Ø P1	6.90	7.10	0.272	0.280
S	4.90	5.10	0.193	0.201

All metal area are tin plated.

**X017c TO-3PFP** Weight = 5.5 g

Dim.	Millimeter		Inches	
	min	max	min	max
A	5.40	5.80	0.213	0.228
A1	3.10	3.50	0.122	0.138
A2	2.90	3.30	0.114	0.130
A3	1.90	2.30	0.075	0.091
b	0.65	0.95	0.026	0.037
b2	1.90	2.30	0.075	0.091
c	0.80	1.10	0.031	0.043
D	24.30	24.70	0.957	0.972
D1	1.30	1.70	0.051	0.067
D2	1.80	2.2	0.071	0.087
E	15.40	15.80	0.606	0.622
E1	3.90	4.30	0.154	0.169
e	5.45 BSC		0.215 BSC	
L	19.00	19.50	0.748	0.768
L1	4.30	4.70	0.169	0.185
Ø P	3.40	3.80	0.134	0.150
R	5.30	5.70	0.209	0.224
S	4.30	4.70	0.169	0.185

1 - GATE  
2 - DRAIN (COLLECTOR)  
3 - SOURCE (EMITTER)

**X018 TO-268 I<sup>3</sup>PAK** Weight = 4.5 g

Dim.	Millimeter		Inches	
	min	max	min	max
A	4.90	5.10	0.193	0.201
A1	2.70	2.90	0.106	0.114
b	1.15	1.45	0.045	0.057
b2	1.90	2.10	0.075	0.083
C	0.40	0.65	0.016	0.026
C 2	1.45	1.60	0.057	0.063
D	13.80	14.00	0.543	0.551
D1	12.40	12.70	0.488	0.500
E	15.85	16.05	0.624	0.632
E1	13.30	13.60	0.524	0.535
e	5.45 BSC		0.215 BSC	
H	34.67	35.43	1.365	1.395
L	19.81	20.32	0.780	0.800
L1	2.00	2.30	0.079	0.091
L2	1.00	1.15	0.039	0.045

**X019 TO-268 AA (D<sup>3</sup>PAK)** Weight = 4 g

Dim.	Millimeter		Inches	
	min	max	min	max
A	4.90	5.10	0.193	0.201
A1	2.70	2.90	0.106	0.114
A2	0.02	0.25	0.001	0.100
b	1.15	1.45	0.045	0.057
b2	1.90	2.10	0.075	0.083
C	0.40	0.65	0.016	0.026
C 2	1.45	1.60	0.057	0.063
D	13.80	14.00	0.543	0.551
D1	12.40	12.70	0.488	0.500
E	15.85	16.05	0.624	0.632
E1	13.30	13.60	0.524	0.535
e	5.45 BSC		0.215 BSC	
H	18.70	19.10	0.736	0.752
L	2.40	2.70	0.094	0.106
L1	1.20	1.40	0.047	0.055
L2	1.00	1.15	0.039	0.045
L3	2.54 BSC		0.100 BSC	
L4	3.80	4.10	0.150	0.161

Dimensions in mm and inches (1 mm = 0.0394")

**XO19a TO-268 AA (D<sup>3</sup>PAK) Weight = 4 g**

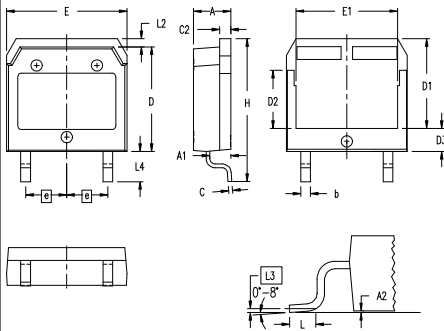

Dim.	Millimeter		Inches	
	min	max	min	max
A	4.90	5.10	0.193	0.201
A1	2.70	2.90	0.106	0.114
A2	0.02	0.25	0.001	0.100
b	1.15	1.45	0.045	0.057
C	0.40	0.65	0.016	0.026
C 2	1.45	1.60	0.057	0.063
D	13.80	14.00	0.543	0.551
D1	11.80	12.10	0.465	0.476
D2	7.50	7.80	0.295	0.307
D3	2.90	3.20	0.114	0.126
E	15.85	16.05	0.624	0.632
E1	13.30	13.60	0.524	0.535
e	5.45 BSC		0.215 BSC	
H	18.70	19.10	0.736	0.752
L	1.70	2.00	0.067	0.079
L2	1.00	1.15	0.039	0.045
L3	0.25 BSC		0.010 BSC	
L4	3.80	4.10	0.150	0.161

**XO20a TO-264 AA Weight = 10 g**

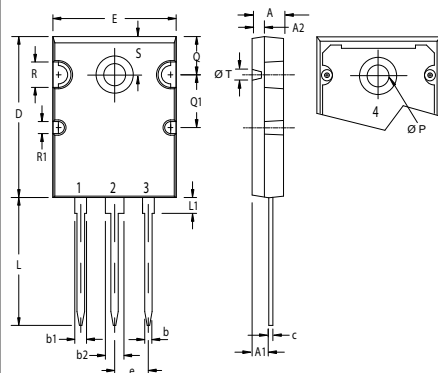

Dim.	Millimeter		Inches	
	min	max	min	max
A	4.82	5.13	0.190	0.202
A1	2.54	2.89	0.100	0.114
A2	2.00	2.10	0.079	0.083
b	1.12	1.42	0.044	0.056
b2	2.90	3.09	0.114	0.122
c	0.53	0.83	0.021	0.033
D	25.91	26.16	1.020	1.030
E	19.81	19.96	0.780	0.786
e	5.45 BSC		0.215 BSC	
J	0.00	0.25	0.000	0.010
K	0.00	0.25	0.000	0.010
L	20.32	20.83	0.800	0.820
L1	2.29	2.59	0.090	0.102
P	3.17	2.66	0.125	0.144
Q	6.07	6.27	0.239	0.247
Q1	8.38	8.69	0.330	0.342
R	3.81	4.32	0.150	0.170
R1	1.78	2.29	0.070	0.090
S	6.04	6.30	0.238	0.248
T	1.57	1.83	0.062	0.072

**XO21a PLUS264™ Weight = 10 g**

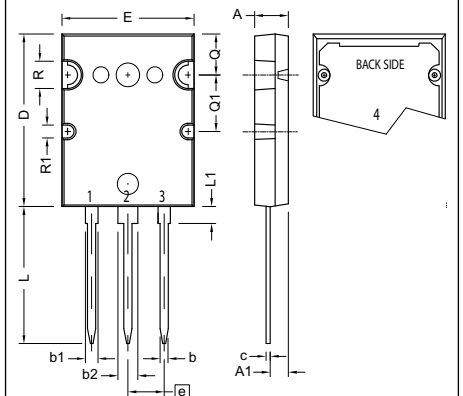

Dim.	Millimeter		Inches	
	min	max	min	max
A	4.70	5.31	0.185	0.209
A1	2.59	3.00	0.102	0.118
b	0.94	1.40	0.037	0.055
b1	2.21	2.59	0.087	0.102
b2	2.79	3.20	0.110	0.126
c	0.43	0.74	0.017	0.029
D	25.58	26.59	1.007	1.047
E	19.30	20.29	0.760	0.799
e	5.45 BSC		0.215 BSC	
L	19.79	21.39	0.779	0.842
L1	2.21	2.59	0.087	0.102
Q	6.10	6.50	0.240	0.256
Q1	8.38	8.79	0.330	0.346
Ø R	3.94	4.75	0.155	0.187
ØR1	2.16	2.36	0.085	0.093

**XO22a ISOPLUS264™ Weight = 7.5 g**

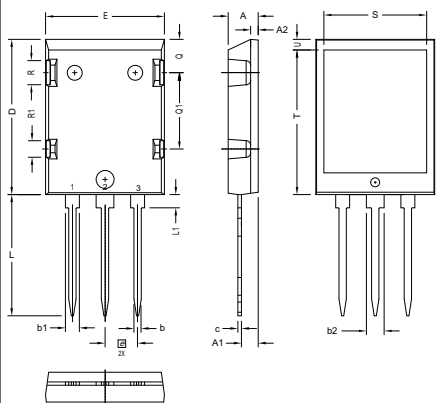

Dim.	Millimeter		Inches	
	min	max	min	max
A	4.83	5.21	0.190	0.205
A1	2.59	3.00	0.102	0.118
A2	1.17	1.40	0.046	0.055
b	1.14	1.40	0.045	0.055
b1	1.60	1.83	0.063	0.072
b2	2.54	2.79	0.100	0.110
b3	1.47	1.73	0.058	0.068
c	0.51	0.74	0.020	0.029
D	25.91	26.42	1.020	1.040
E	19.56	20.29	0.770	0.799
e	3.81 BSC		0.150 BSC	
L	19.81	21.83	0.780	0.820
L1	2.03	2.59	0.080	0.102
Q	5.33	5.97	0.210	0.235
Q1	12.45	13.03	0.490	0.513
R	3.81	4.57	0.150	0.180
R1	2.54	3.30	0.100	0.130
S	16.97	17.53	0.668	0.690
T	20.34	20.85	0.801	0.821
U	1.65	2.03	0.065	0.080

**XO22 ISOPLUS264™ Weight = 7.5 g**

- c) 5 pin
- d) 3 (sym) w/o pin 2 & 4
- e) 3 (HV) w/o pin 3 & 4

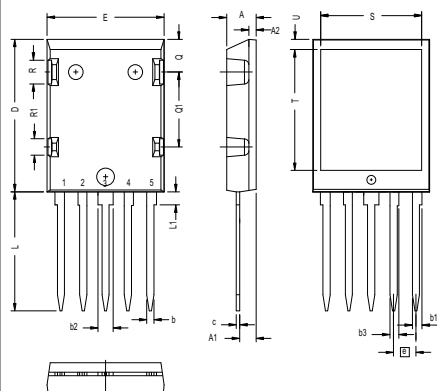

Dim.	Millimeter		Inches	
	min	max	min	max
A	4.83	5.21	0.190	0.205
A1	2.59	3.00	0.102	0.118
A2	1.17	1.40	0.046	0.055
b	1.14	1.40	0.045	0.055
b1	1.60	1.83	0.063	0.072
b2	2.54	2.79	0.100	0.110
b3	1.47	1.73	0.058	0.068
c	0.51	0.74	0.020	0.029
D	25.91	26.42	1.020	1.040
E	19.56	20.29	0.770	0.799
e	3.81 BSC		0.150 BSC	
L	19.81	21.83	0.780	0.820
L1	2.03	2.59	0.080	0.102
Q	5.33	5.97	0.210	0.235
Q1	12.45	13.03	0.490	0.513
R	3.81	4.57	0.150	0.180
R1	2.54	3.30	0.100	0.130
S	16.97	17.53	0.668	0.690
T	20.34	20.85	0.801	0.821
U	1.65	2.03	0.065	0.080

**XO23 ISO264™ Weight = 6.5 g**

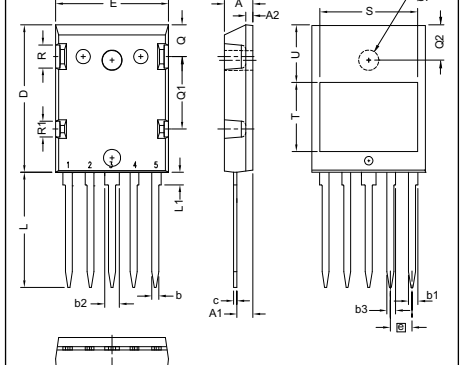

Dim.	Millimeter		Inches	
	min	max	min	max
A	4.83	5.21	0.190	0.205
A1	2.59	3.00	0.102	0.118
A2	1.17	1.40	0.046	0.055
b	1.14	1.40	0.045	0.055
b1	1.60	1.83	0.063	0.072
b2	2.54	2.79	0.100	0.110
b3	1.47	1.73	0.058	0.068
c	0.51	0.74	0.020	0.029
D	25.91	26.42	1.020	1.040
E	19.56	20.29	0.770	0.799
e	3.81 BSC		0.150 BSC	
L	19.81	21.83	0.780	0.820
L1	2.03	2.59	0.080	0.102
P	3.30	3.68	0.130	0.145
Q	5.33	5.97	0.210	0.235
Q1	12.45	13.03	0.490	0.513
Q2	5.96	6.48	0.235	0.255
R	3.81	4.57	0.150	0.180
R1	2.54	3.30	0.100	0.130
S	16.97	17.53	0.668	0.690
T	11.94	12.45	0.470	0.490
U	9.91	10.41	0.390	0.410

Dimensions in mm and inches (1 mm = 0.0394")

<b>X024a ISOPLUS i4-PAC™</b> Weight = 6 g		<b>X024b ISOPLUS i4-PAC™</b> Weight = 5.5 g		<b>X024c ISOPLUS i4-PAC™</b> Weight = 5.5 g	
<p>* middle pin cut or not existing depending on assembly line</p>					
Dim.	Millimeter		Inches		
	min	max	min	max	
A	4.83	5.21	0.190	0.205	
A1	2.59	3.00	0.102	0.118	
A2	1.17	2.16	0.046	0.085	
b	1.14	1.40	0.045	0.055	
b2	1.47	1.73	0.058	0.068	
b4	2.54	2.79	0.100	0.110	
c	0.51	0.74	0.020	0.029	
D	20.80	21.34	0.819	0.840	
D1	14.99	15.75	0.590	0.620	
D2	1.65	2.03	0.065	0.080	
D3	20.30	20.70	0.799	0.815	
E	19.56	20.29	0.770	0.799	
E1	16.76	17.53	0.660	0.690	
e	3.81 BSC		0.150 BSC		
L	19.81	21.34	0.780	0.840	
L1	2.11	2.59	0.083	0.102	
Q	5.33	6.20	0.210	0.244	
R	2.54	4.57	0.100	0.180	
W	-	0.10	-	0.004	

Dim.	Millimeter		Inches		
	min	max	min	max	
A	4.83	5.21	0.190	0.205	
A1	2.59	3.00	0.102	0.118	
A2	1.17	2.16	0.046	0.085	
b	1.14	1.40	0.045	0.055	
b2	1.47	1.73	0.058	0.068	
b4	2.54	2.79	0.100	0.110	
c	0.51	0.74	0.020	0.029	
D	20.80	21.34	0.819	0.840	
D1	14.99	15.75	0.590	0.620	
D2	1.65	2.03	0.065	0.080	
D3	20.30	20.70	0.799	0.815	
E	19.56	20.29	0.770	0.799	
E1	16.76	17.53	0.660	0.690	
e	7.62 BSC		0.300 BSC		
L	19.81	21.34	0.780	0.840	
L1	2.11	2.59	0.083	0.102	
Q	5.33	6.20	0.210	0.244	
R	2.54	4.57	0.100	0.180	
W	-	0.10	-	0.004	

Dim.	Millimeter		Inches		
	min	max	min	max	
A	4.83	5.21	0.190	0.205	
A1	2.59	3.00	0.102	0.118	
A2	1.17	2.16	0.046	0.085	
b	1.14	1.40	0.045	0.055	
b2	1.47	1.73	0.058	0.068	
b4*	2.54	2.79	0.100	0.110	
c	0.51	0.74	0.020	0.029	
D	20.80	21.34	0.819	0.840	
D1	14.99	15.75	0.590	0.620	
D2	1.65	2.03	0.065	0.080	
D3	20.30	20.70	0.799	0.815	
E	19.56	20.29	0.770	0.799	
E1	16.76	17.53	0.660	0.690	
e	3.81 BSC		0.150 BSC		
e1	11.43 BSC		0.450 BSC		
L	19.81	21.34	0.780	0.840	
L1	2.11	2.59	0.083	0.102	
Q	5.33	6.20	0.210	0.244	
R	2.54	4.57	0.100	0.180	
W	-	0.10	-	0.004	

**X024d ISOPLUS i4-PAC™** Weight = 6 g		**X024e ISOPLUS i4-PAC™** Weight = 6 g		**X025a GBFP** Weight = 7 g	
Dim.	Millimeter		Inches		
	min	max	min	max	
A	4.83	5.21	0.190	0.205	
A1	2.59	3.00	0.102	0.118	
A2	1.17	2.16	0.046	0.085	
b	1.14	1.40	0.045	0.055	
b2	1.47	1.73	0.058	0.068	
c	0.51	0.74	0.020	0.029	
D	20.80	21.34	0.819	0.840	
D1	14.99	15.75	0.590	0.620	
D2	1.65	2.03	0.065	0.080	
D3	20.30	20.70	0.799	0.815	
E	19.56	20.29	0.770	0.799	
E1	16.76	17.53	0.660	0.690	
e	3.81 BSC		0.150 BSC		
L	19.81	21.34	0.780	0.840	
L1	2.11	2.59	0.083	0.102	
Q	5.33	6.20	0.210	0.244	
R	2.54	4.57	0.100	0.180	
W	-	0.10	-	0.004	

Dim.	Millimeter		Inches		
	min	max	min	max	
A	4.83	5.21	0.190	0.205	
A1	2.59	3.00	0.102	0.118	
A2	1.17	2.16	0.046	0.085	
b	1.14	1.40	0.045	0.055	
b2	1.47	1.73	0.058	0.068	
c	0.51	0.74	0.020	0.029	
D	20.80	21.34	0.819	0.840	
D1	14.99	15.75	0.590	0.620	
D2	1.65	2.03	0.065	0.080	
D3	20.30	20.70	0.799	0.815	
E	19.56	20.29	0.770	0.799	
E1	16.76	17.53	0.660	0.690	
e	15.24 BSC		0.600 BSC		
L	19.81	21.34	0.780	0.840	
L1	2.11	2.59	0.083	0.102	
Q	5.33	6.20	0.210	0.244	
R	2.54	4.57	0.100	0.180	
W	-	0.10	-	0.004	

Dim.	Millimeter		Inches		
	min	max	min	max	
A	29.70	30.30	1.170	1.194	
B	19.70	20.30	0.776	0.800	
C	17.00	18.00	0.670	0.709	
D	4.70	4.90	0.185	0.193	
E	10.80	11.20	0.426	0.441	
F	2.30	2.70	0.091	0.106	
G	3.10	3.40	0.122	0.134	
H	3.40	3.80	0.134	0.150	
I	4.40	4.80	0.173	0.189	
J	2.50	2.90	0.099	0.114	
K	0.60	0.80	0.024	0.032	
L	2.00	2.40	0.079	0.095	
M	0.90	1.10	0.035	0.043	
N	9.80	10.20	0.386	0.402	
O	7.30	7.70	0.288	0.303	
P	3.80	4.20	0.150	0.165	
Q	(3.0) x 45°		(0.118) x 45°		
Ø R	3.1	3.4	0.122	0.134	

Dimensions in mm and inches (1 mm = 0.0394")

**X025b GUPF**

Weight = 8.5 g

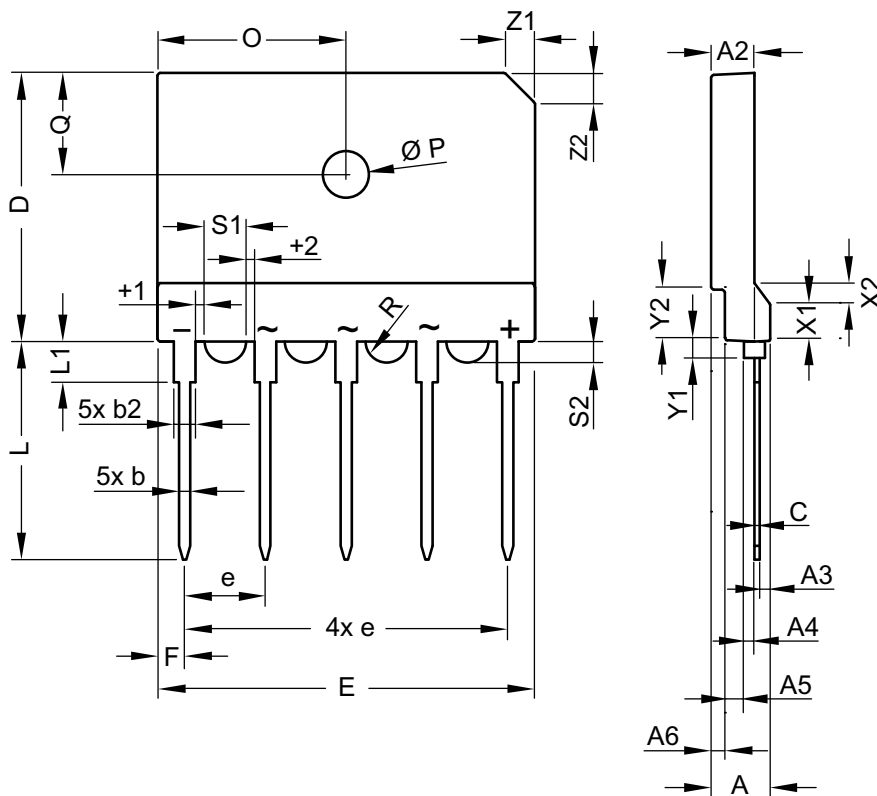

Dim.	Millimeter			Inches		
	min	typ.	max	min	typ.	max
A	5.40	5.50	5.60	0.213	0.217	0.221
A2	3.90	4.00	4.10	0.154	0.158	0.162
A3	0.95	1.00	1.10	0.037	0.039	0.043
A4	0.95	1.00	1.05	0.037	0.039	0.041
A5	1.60	1.70	1.80	0.063	0.067	0.071
A6	1.25	1.30	1.35	0.049	0.051	0.053
b	0.95	1.00	1.05	0.037	0.039	0.041
b2	1.95	2.00	2.05	0.077	0.079	0.081
C	0.45	0.50	0.55	0.018	0.020	0.022
D	24.80	25.00	25.20	0.977	0.985	0.993
E	34.70	35.00	35.30	1.367	1.379	1.391
e	BSC	7.50		BSC	0.296	
F	2.40	2.50	2.60	0.095	0.099	0.102
L	2.30	20.40	2.50	0.091	0.804	0.099
L1	3.70	3.75	3.80	0.146	0.148	0.150
O	17.40	17.50	17.60	0.686	0.690	0.693
Ø P	4.10	4.20	4.30	0.162	0.165	0.169
Q	9.20	9.30	9.40	0.362	0.366	0.370
1/2 R	-	1.77	-	-	0.070	-
s1	3.45	3.50	3.55	0.136	0.138	0.140
s2	1.45	1.50	1.55	0.057	0.059	0.061
t1	0.95	1.00	1.05	0.037	0.039	0.041
t2	0.95	1.00	1.05	0.037	0.039	0.041
x1	3.20	3.30	3.40	0.126	0.130	0.134
x2	1.90	2.00	2.10	0.075	0.079	0.083
y1	1.60	1.65	1.70	0.063	0.065	0.067
y2	4.65	4.70	4.75	0.183	0.185	0.187
z1	2.80	2.90	3.00	0.110	0.114	0.118

**X026c ISOPLUS™-DIL (SMD)**

Weight = 13 g

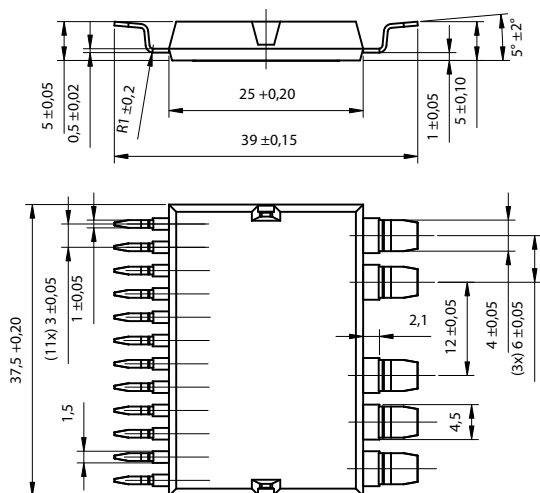

**X026d ISOPLUS™-DIL (SMD)**

Weight = 13 g

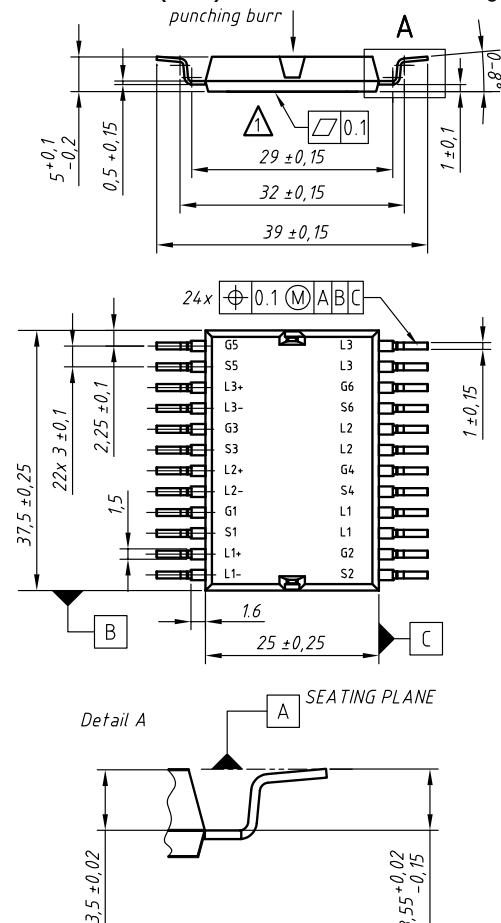

Dimensions in mm and inches (1 mm = 0.0394")

**X027a SOT-227 B miniBLOC** Weight = 29 g  
**X027b SOT-227 UI miniBLOC**

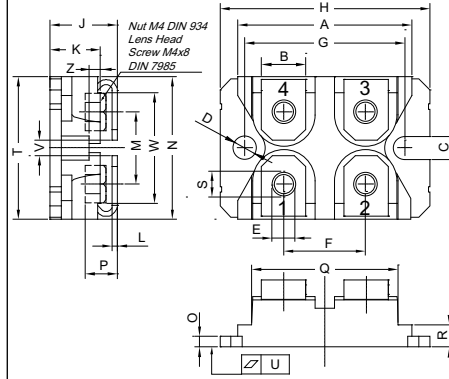

Dim.	Millimeter		Inches	
	min	max	min	max
A	31.50	31.88	1.240	1.255
B	7.80	8.20	0.307	0.323
C	4.09	4.29	0.161	0.169
D	4.09	4.29	0.161	0.169
E	4.09	4.29	0.161	0.169
F	14.91	15.11	0.587	0.595
G	30.12	30.30	1.186	1.193
H	37.80	38.23	1.488	1.505
J	11.68	12.22	0.460	0.481
K	8.92	9.60	0.351	0.378
L	0.74	0.84	0.029	0.033
M	12.50	13.10	0.492	0.516
N	25.15	25.42	0.990	1.001
O	1.95	2.13	0.077	0.084
P	4.95	6.20	0.195	0.244
Q	26.54	26.90	1.045	1.059
R	3.94	4.42	0.155	0.174
S	4.55	4.85	0.179	0.191
T	24.59	25.25	0.968	0.994
U	-0.05	0.10	-0.002	0.004
V	3.20	5.50	0.126	0.217
W	19.81	21.08	0.780	0.830
Z	2.50	2.70	0.098	0.106

**X028 ISOPLUS227™** Weight = 19 g

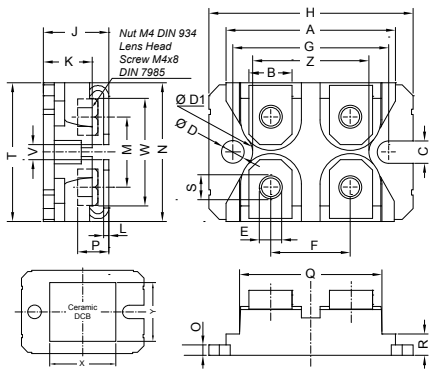

Dim.	Millimeter		Inches	
	min	max	min	max
A	31.50	32.26	1.240	1.270
B	7.87	8.38	0.310	0.330
C	3.94	4.19	0.155	0.165
D	3.94	4.19	0.155	0.165
D1	3.81	3.98	0.150	0.157
E	4.06	4.27	0.160	0.168
F	14.91	15.11	0.587	0.595
G	30.12	30.30	1.186	1.193
H	37.80	38.23	1.489	1.505
J	11.81	12.22	0.465	0.481
K	9.40	9.65	0.370	0.380
L	0.76	0.84	0.030	0.033
M	12.60	12.85	0.496	0.506
N	25.15	25.42	0.990	1.001
O	2.54	2.64	0.100	0.105
P	4.95	5.97	0.195	0.235
Q	26.54	26.90	1.045	1.059
R	4.06	4.32	0.160	0.170
S	4.72	4.85	0.186	0.191
T	24.59	25.07	0.968	0.987
U	-0.03	0.05	-0.001	0.002
V	3.30	4.06	0.130	0.160
W	19.81	21.08	0.780	0.830
X	19.56	20.57	0.770	0.810
Y	17.27	18.29	0.680	0.720
Z	22.48	22.66	0.885	0.892

**X030a SMPD-B**

Weight = 8.5 g

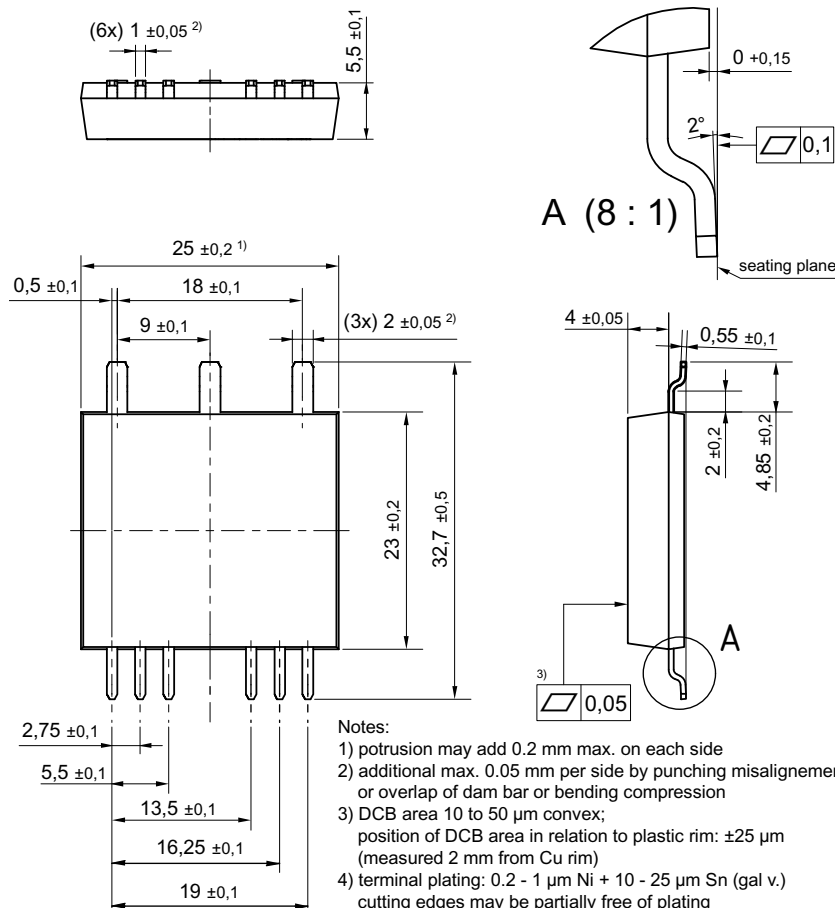

**X030b SMPD-B**

Weight = 8.5 g

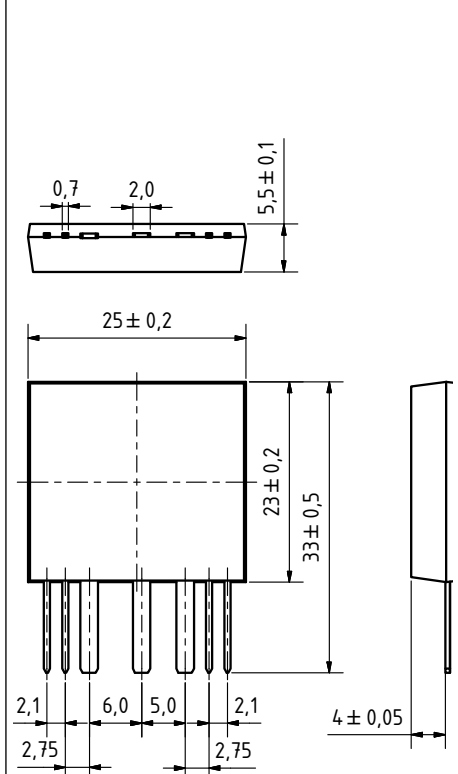



Dimensions in mm and inches (1 mm = 0.0394")

**X031a SMPD-X** See data sheet for pin arrangement Weight = 8.5 g

Dim.	Millimeter		Inches	
	min	max	min	max
A	5.30	5.70	0.209	0.224
A1	3.90	4.10	0.154	0.161
A2	1.40	1.60	0.055	0.063
b	0.90	1.15	0.035	0.045
c	0.45	0.65	0.018	0.026
D	24.80	25.25	0.976	0.994
E	22.80	23.25	0.898	0.915
E1	13.80	14.20	0.543	0.559
e	2.00	BSC	0.079	BSC
e1	8.00	BSC	0.315	BSC
H	32.30	33.30	1.272	1.311
L	4.60	5.30	0.181	0.209
L1	1.30	1.70	0.051	0.067
L2	0.00	0.15	0.000	0.006
S	18.85	20.12	0.742	0.792
S1	1.45	2.08	0.057	0.082
T	20.90	22.17	0.823	0.873
T1	1.42	2.03	0.056	0.080
a	4°	-	4°	-

Note:  
 1. Bottom heatsink meets 2.6 kV AC isolation to the other pins.  
 2. All leads are matte pure tin plated.

**X031b SMPD-X**

SYM	INCHES		MILLIMETERS	
	MIN	MAX	MIN	MAX
A	.209	.224	5.30	5.70
A1	.154	.161	3.90	4.10
A2	.055	.063	1.40	1.60
b	.035	.045	0.90	1.15
c	.018	.026	0.45	0.65
D	.976	.994	24.80	25.25
E	.898	.915	22.80	23.25
E1	.543	.559	13.80	14.20
e	.079 BSC		2.00 BSC	
e1	.394 BSC		10.00 BSC	
e2	.315 BSC		8.00 BSC	
H	1.272	1.311	32.30	33.30
L	.181	.209	4.60	5.30
L1	.051	.067	1.30	1.70
L2	.000	.006	0.00	0.15
S	.742	.792	18.85	20.12
S1	.057	.082	1.45	2.08
T	.823	.873	20.90	22.17
T1	.069	.089	1.75	2.25
α	0	4°	0	4°

NOTE:  
 1. Bottom heatsink meets 2.6KV AC isolation to the other pins.  
 2. All leads are matte pure tin plated.

Dimensions in mm and inches (1 mm = 0.0394")

**X031c SMPD-X** Weight = 8.5 g

SYM	INCHES		MILLIMETERS	
	MIN	MAX	MIN	MAX
A	.209	.224	5.30	5.70
A1	.154	.161	3.90	4.10
A2	.055	.063	1.40	1.60
b	.035	.045	0.90	1.15
c	.018	.026	0.45	0.65
D	.976	.994	24.80	25.25
E	.898	.915	22.80	23.25
E1	.543	.559	13.80	14.20
e	.157 BSC		4.00 BSC	
e1	.394 BSC		10.00 BSC	
e2	.472 BSC		12.00 BSC	
H	1.272	1.311	32.30	33.30
L	.181	.209	4.60	5.30
L1	.051	.067	1.30	1.70
L2	.000	.006	0.00	0.15
S	.748	.807	19.00	20.50
S1	.039	.079	1.00	2.00
T	.826	.886	21.00	22.50
T1	.039	.079	1.00	2.00
α	0	4°	0	4°

**NOTE:**  
 1. Bottom DCB heatsink meets 2.6KV AC, 2 Sec isolation to the other pins.  
 2. All leads are matte pure tin plated.

**X101 ECO-PAC1** Weight = 19 g

See data sheet for pin arrangement

**X102 ECO-PAC2** Weight = 23 g

See data sheet for pin arrangement

**X103 V1-A-Pack** Weight = 37 g

See data sheet for pin arrangement



Dimensions in mm and inches (1 mm = 0.0394")

## X110 MiniPack2

See data sheet for pin arrangement

Weight = 37 g

A (2:1)

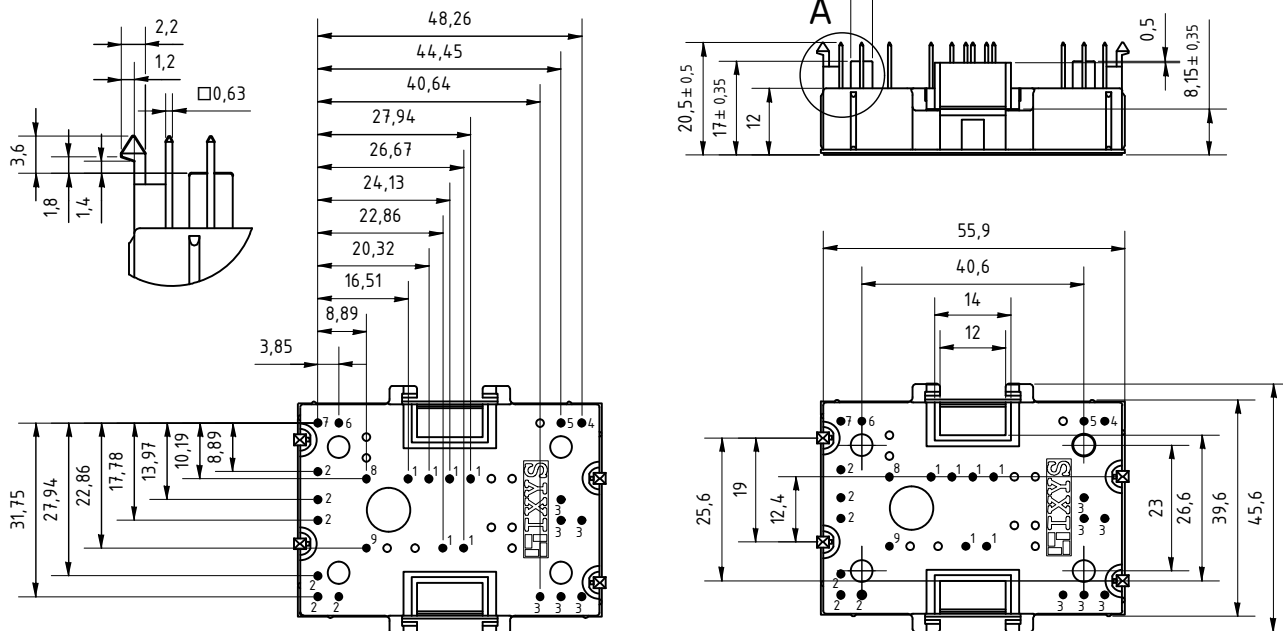

**Bemerkungen:**

- 1) Toleranz für Pin Positionen entsprechend  $\Phi \pm 0,4$
- 2) Vorgesehen für die Montage auf Leiterplatten mit einer Dicke von  $1,6 \pm 0,2$  mm

**Remarks:**

- 1) Pin positions with tolerance  $\Phi \pm 0.4$
- 2) Mounting on PCB with thickness of  $1.6 \pm 0.2$  mm

## X111 E1-Pack

See data sheet for pin arrangement

Weight = 39 g

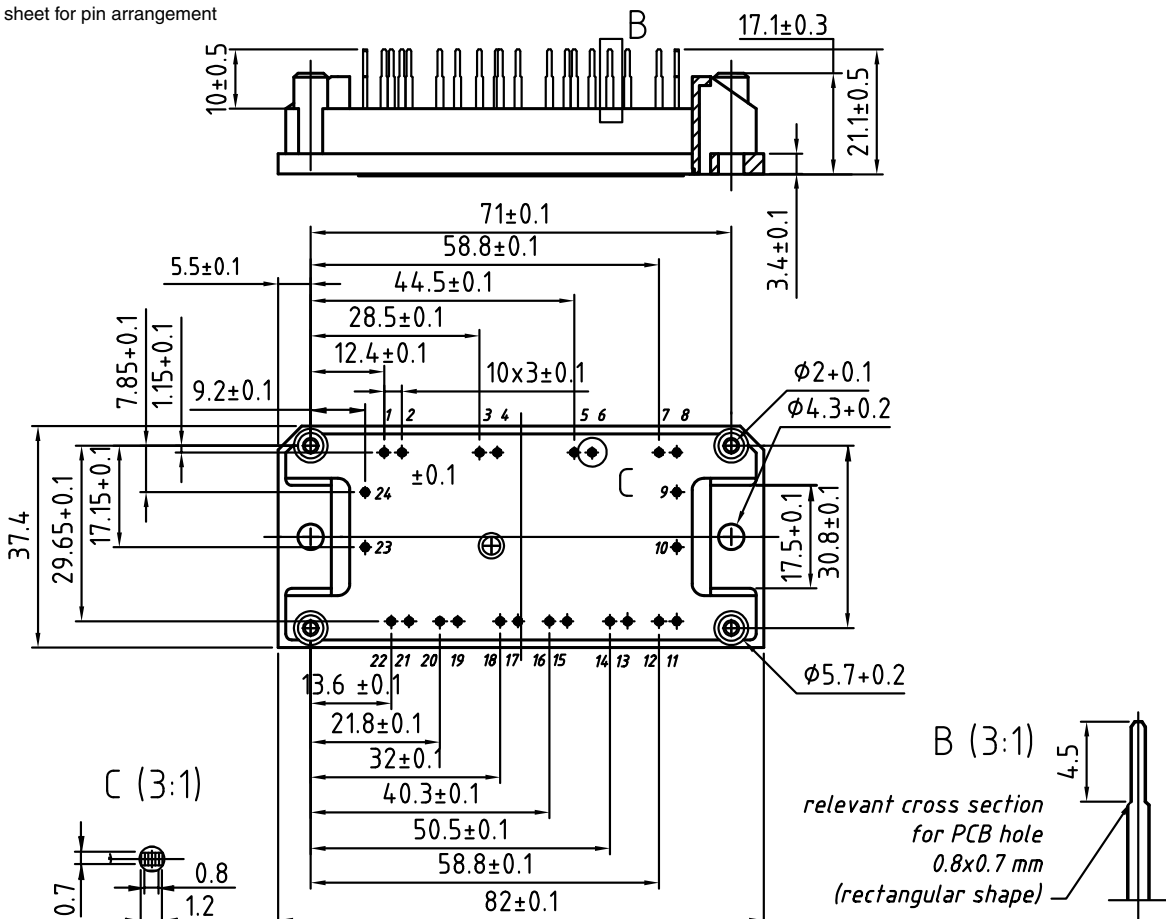

Dimensions in mm and inches (1 mm = 0.0394")

## X112 E2-Pack

Weight = 176 g

See data sheet for pin arrangement

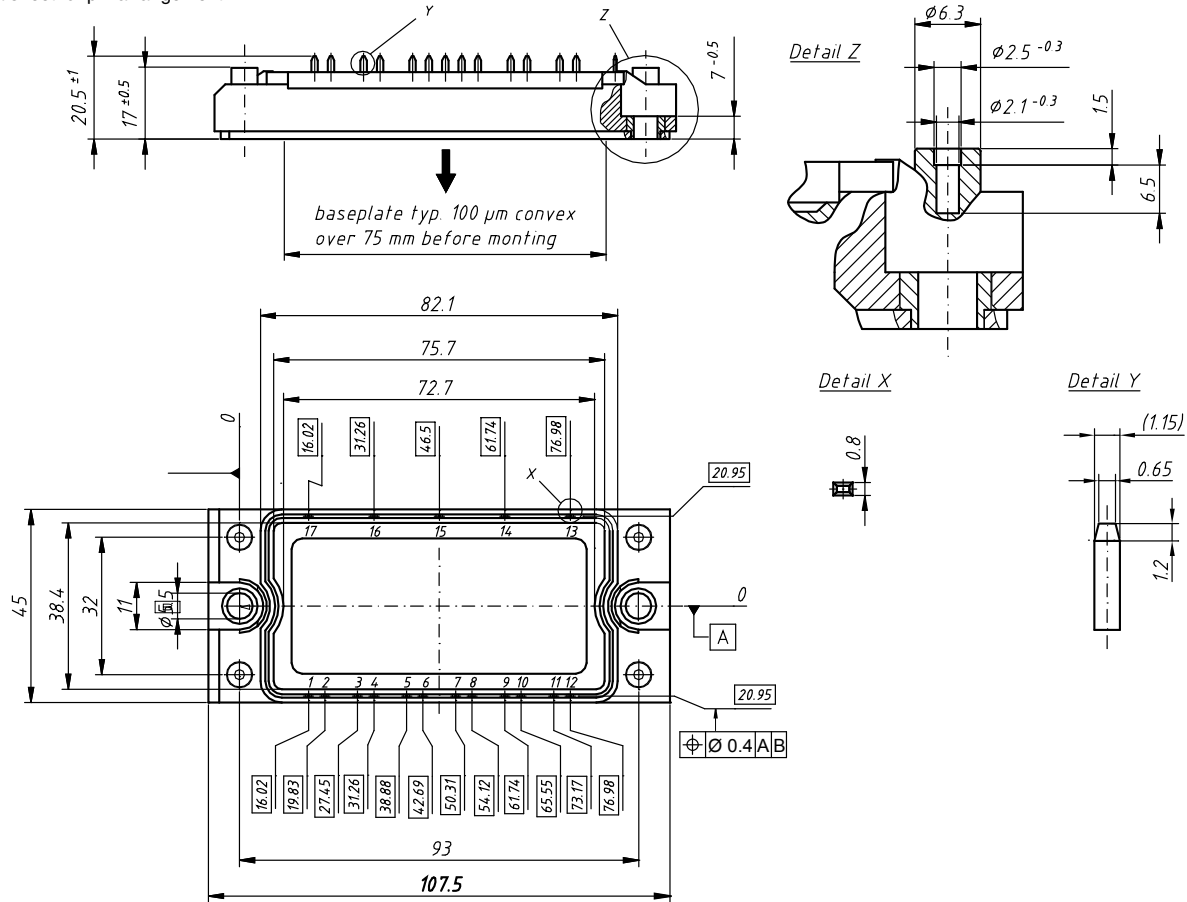

## X113 E3-Pack

Weight = 270 g

See data sheet for pin arrangement

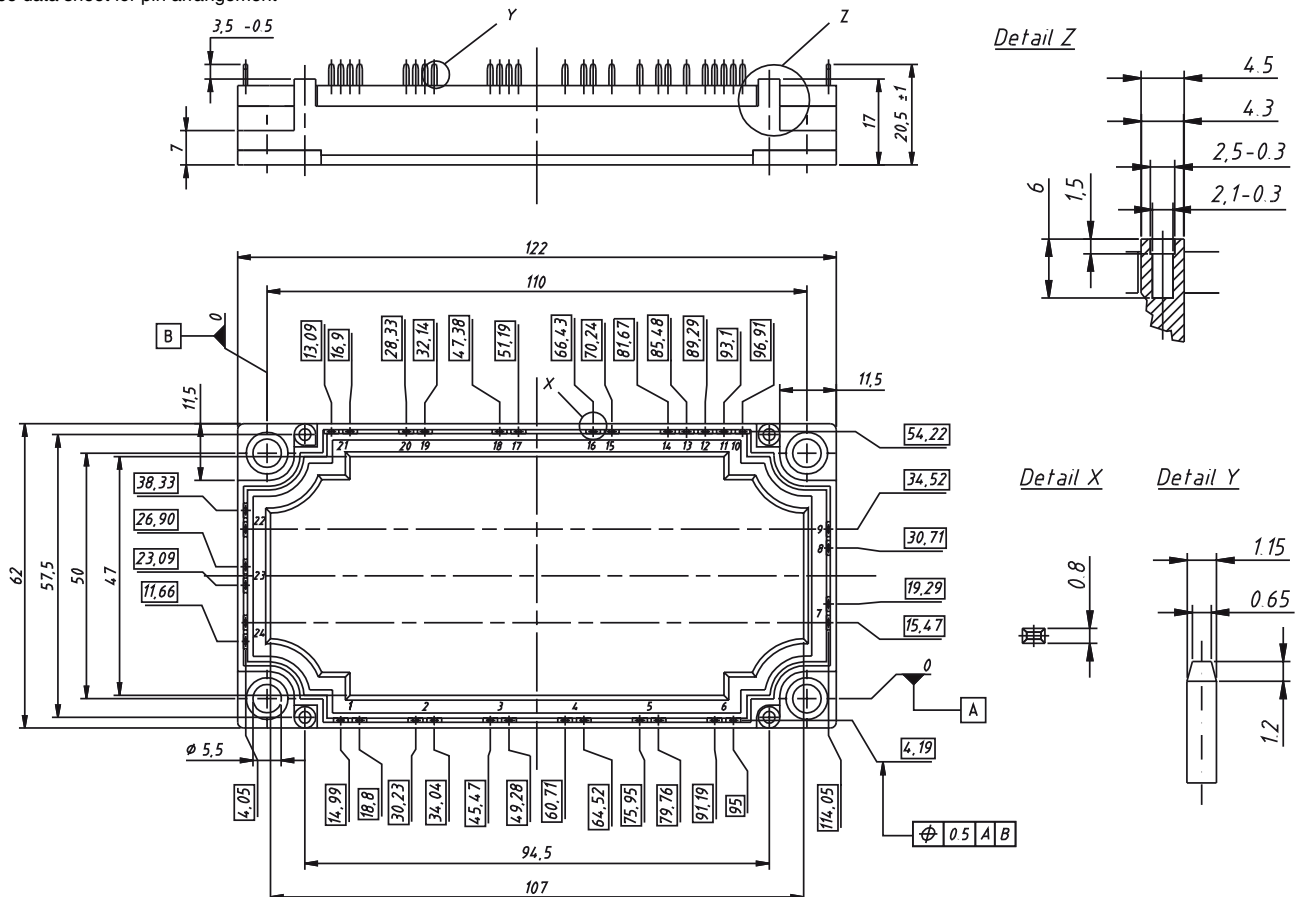

Dimensions in mm and inches (1 mm = 0.0394")

## X114 E9-Pack

See data sheet for pin arrangement

Weight = 835 g

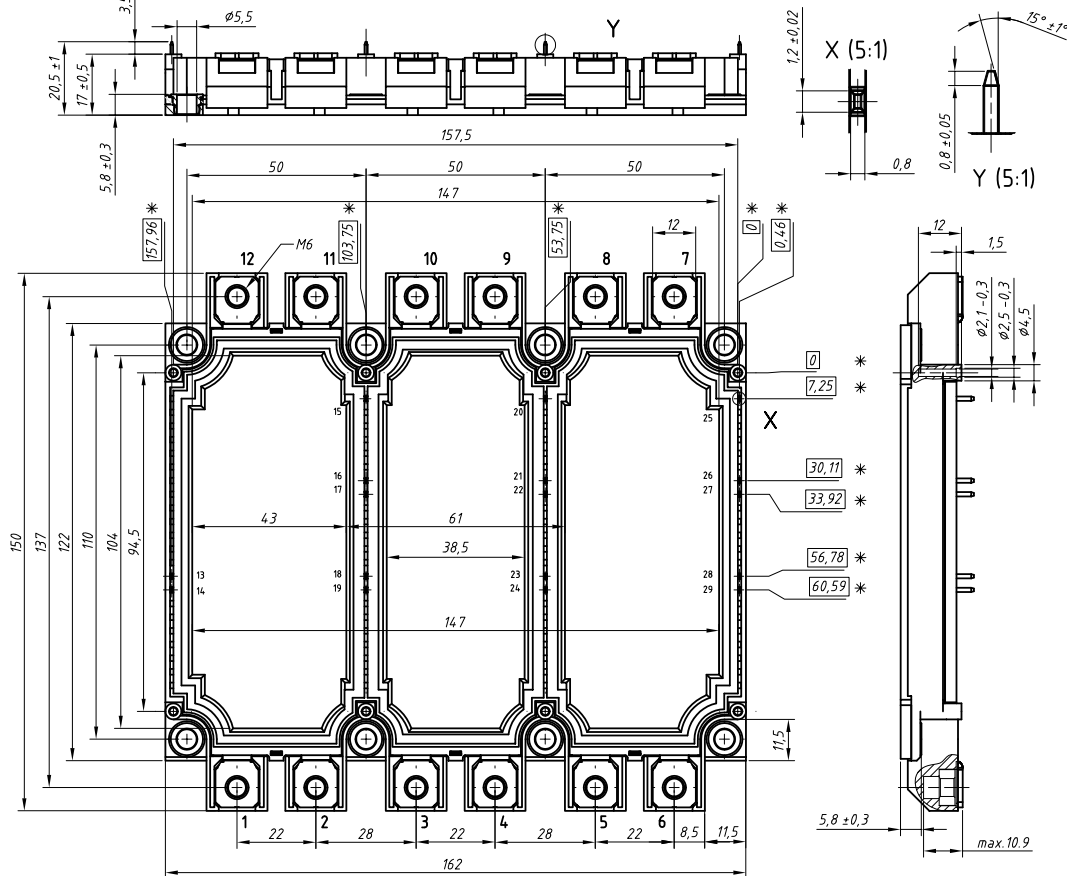

## X115 FO-A

Weight = 15 g

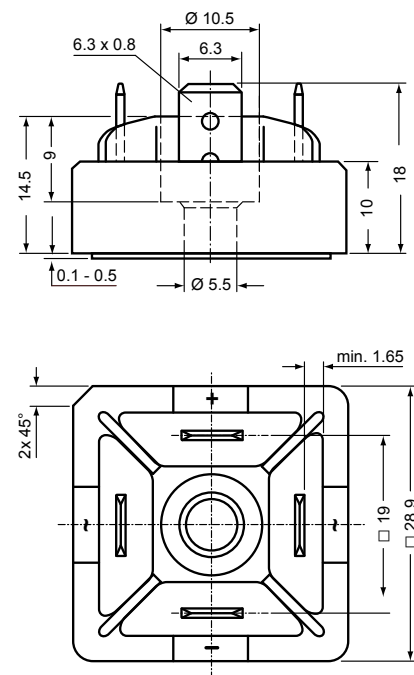

## X116 FO-B

Weight = 20 g  
a: VUO  
b: w/o terminal C (VBO)

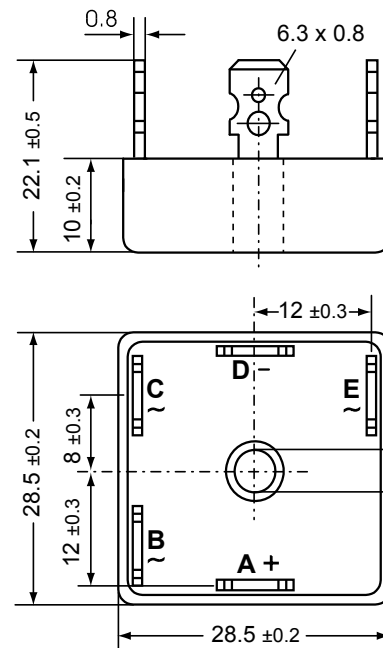

## X117a FO-F-A

Weight = 45 g

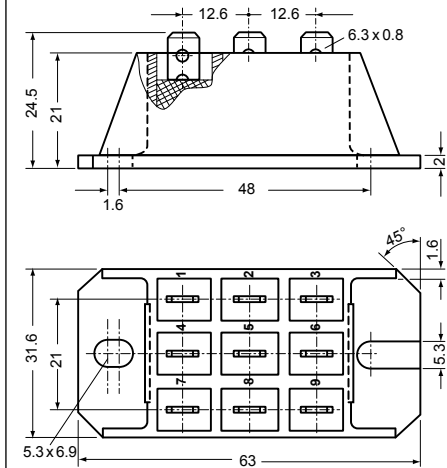

Dimensions in mm and inches (1 mm = 0.0394")

<p><b>X117b FO-F-B</b> Weight = 45 g</p>	<p><b>X118 FO-T-A</b> Weight = 104 g                      c: w/o terminal 4, 5, &amp; 6 (VVZ &amp; VVZF)                      d: w/o terminal 1, 2, 3, 4, 5, &amp; 6 (VUO)</p> <p>See data sheet for pin arrangement</p>	
<p><b>X119 PWS-A</b> Weight = 104 g                      a: VUO                      b: w/o terminal D (VBO)</p>	<p><b>X120 PWS-B</b> Weight = 203 g                      a: VUO                      b: w/o terminal D (VBO)</p>	<p><b>X121 PWS-C</b> Weight = 250 g                      a: VUO                      b: w/o terminal D (VBO)</p>

Dimensions in mm and inches (1 mm = 0.0394")

<p><b>X122 PWS-D</b> Weight =                      a: VUO 159 g                      b: w/o terminal C (VBO) 153 g</p>	<p><b>X122 PWS-D Flat</b> Weight =                      c: VUO 118 g</p> <p>Max. allowed screw-in depth: 6 mm</p>	<p><b>X123 PWS-E</b> Weight =                      a: VTO 284 g                      b: w/o terminal 4, 5 &amp; 6 (VVZ) 284 g                      c: w/o terminal 1, 2, 3, 4, 5 &amp; 6 (VUO) 284 g                      d: w/o terminal D, 3, 4, 5 &amp; 6 (VHF) 273 g                      e: w/o terminal D, 1, 2, 3, 4, 5 &amp; 6 (VBO) 273 g</p>
<p><b>X123 PWS-E Flat</b> Weight = 220 g                      h: w/o terminal 1, 2, 3, 4, 5 &amp; 6 (VUO)</p> <p>Max. allowed screw-in depth: 7.2 mm</p>	<p><b>X125 TO-240 AA</b> Weight =</p> <ul style="list-style-type: none"> <li>a: + Kelvin contact (MCC) 81 g</li> <li>b: + Kelvin contact, w/o pin 6 &amp; 7 (MCD) 81 g</li> <li>c: w/o Kelvin contact 4 &amp; 7 (MCC) 81 g</li> <li>d: w/o Kelvin contact 4, 7 &amp; pin 6 (MCD) 81 g</li> <li>e: w/o pin 4, 5, 6 &amp; 7 (MDD) 81 g</li> <li>f: w/o terminal 2 and pin 4 &amp; 7 (VMO) 74 g</li> <li>g: + Kelvin contact, w/o pin 7 (VMM) 81 g</li> </ul> <p>A 2.8 - 0.8 DIN 46244</p> <p>General tolerance: DIN ISO 2768 class „c“</p> <p>Optional accessories: Keyed gate/cathode twin plugs                      Wire length: 350 mm, gate = white, cathode = red                      UL 758, style 3751                      Type ZY 200L (L = Left for pin pair 4/5)                      Type ZY 200R (R = Right for pin pair 6/7)</p>	



Dimensions in mm and inches (1 mm = 0.0394")

**X126 Y4-M6** Weight =  
 a: + Kelvin cont., w/o pin 8 up to 11 (MCC) 131 g  
 b: + Kelvin cont., w/o pin 6 up to 11 (MCD) 131 g  
 c: w/o pin 4 up to 11 (MDD) 126 g  
 d: w/o terminal 2 & pin 4 up to 11 (MEO) 108 g

Optional accessories for modules  
 Keyed gate/cathode twin plugs with wire length = 350 mm, gate = white, cathode = red  
 Type ZY 180L (L = Left for pin pair 4/5) } UL 758, style 3751  
 Type ZY 180R (R = Right for pin pair 6/7)

**X127 Y4-M5** Weight =  
 a: w/o pin 8 up to 11 (MII) 110 g  
 b: w/o pin 6 up to 11 (MID) 108 g  
 c: w/o pin 4, 5 & 8 up to 11 (MDI) 108 g

General tolerances:  
 DIN ISO 2768-T1-m

**X128 Y3-DCB** Weight =  
 a: w/o pin 4 up to 7 (VMM, MII) 222 g  
 b: w/o pin 4 up to 9 (MID) 220 g  
 c: w/o pin 4 up to 7, 10 & 11 (MDI) 220 g  
 d: w/o terminal 3 & pin 6 up to 11 (VMO) 200 g

**X129 Y2-DCB** Weight =  
 a: + Kelvin contact (MCC) 245 g  
 b: + Kelvin contact, w/o pin 6 & 7 (MCD) 245 g  
 c: w/o pin 4, 5, 6 & 7 (MDD) 244 g

**X130 Y3-Li** Weight =  
 a: w/o pin 4-7, low inductance (VMM, MII) 226 g  
 b: w/o pin 4-9, low inductance (MID) 226 g  
 c: w/o pin 4-7, 10&11, low inductance (MDI) 226 g  
 d: w/o terminal 1&pin 6-11, low ind. (VMO) 206 g  
 e: w/o pin 4&5, low ind. (VMM, MII+NTC) 226 g  
 f: w/o pin 4, 5, 8 & 9, low ind. (MID+NTC) 226 g

**X131 Y1-CU** Weight =  
 a: + Kelvin contact (MCC) 680 g  
 b: + Kelvin contact, w/o pin 6&7 (MCD) 680 g  
 c: w/o pin 4, 5, 6 & 7 (MDD) 680 g

Optional accessories for modules  
 Keyed gate/cathode twin plugs with wire length = 350 mm, gate = white, cathode = red  
 Type ZY 180L (L = Left for pin pair 4/5) } UL 758, style 3751  
 Type ZY 180R (R = Right for pin pair 6/7)

Dimensions in mm and inches (1 mm = 0.0394")

### X132 Y1-2-CU

a: + Kelvin contact and pin 6&7 (MCO)  
b: w/o pin 4, 5, 6 & 7 (MDO)

Weight = 650 g  
650 g

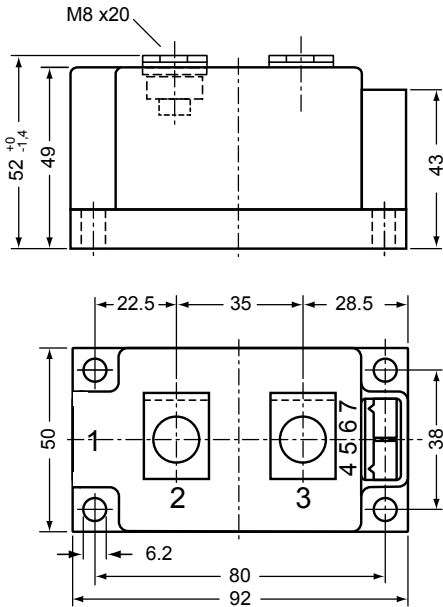

### X141 SimBus A

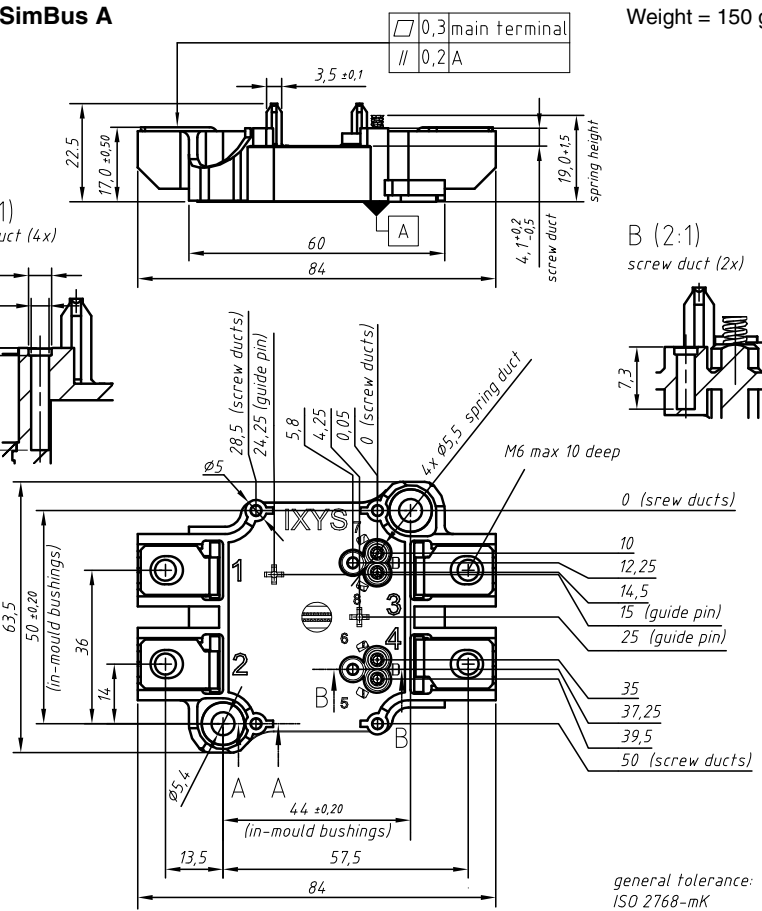
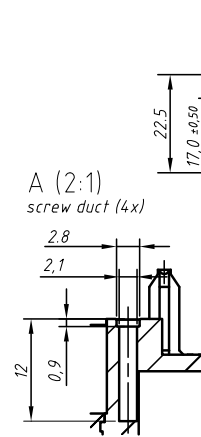

### X142a ComPack

Weight = ??? g

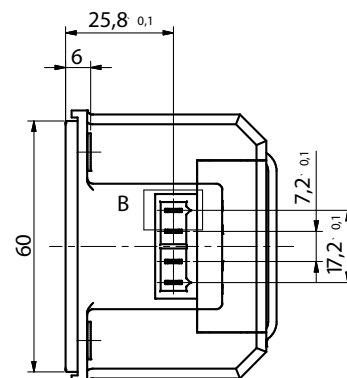
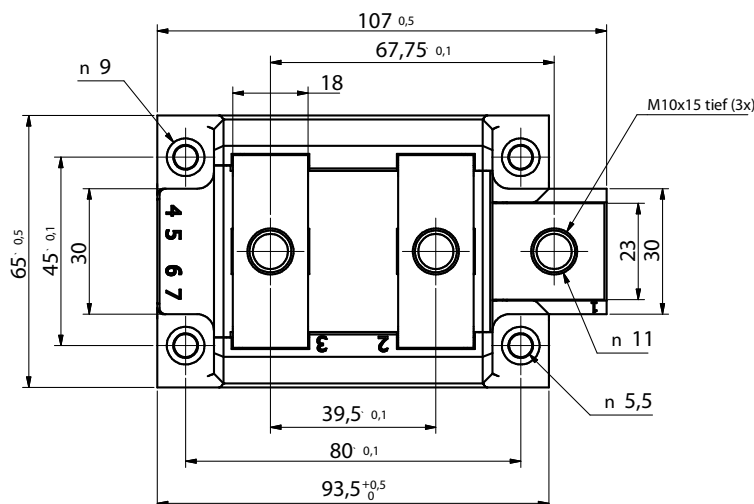
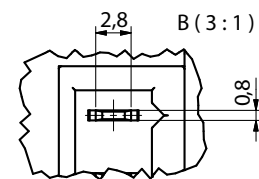
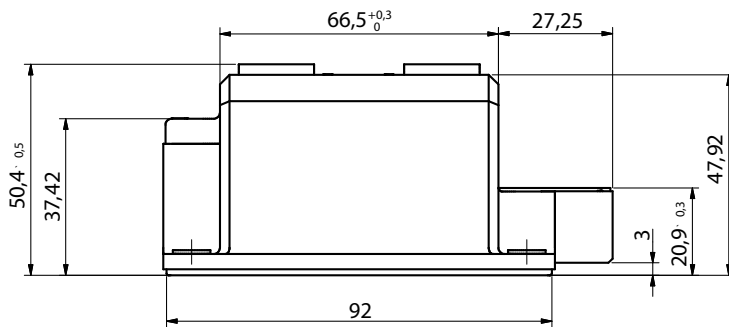

# Outline drawings

Dimensions in mm and inches (1 mm = 0.0394")

**X143a SimBus F**

Weight = 150 g

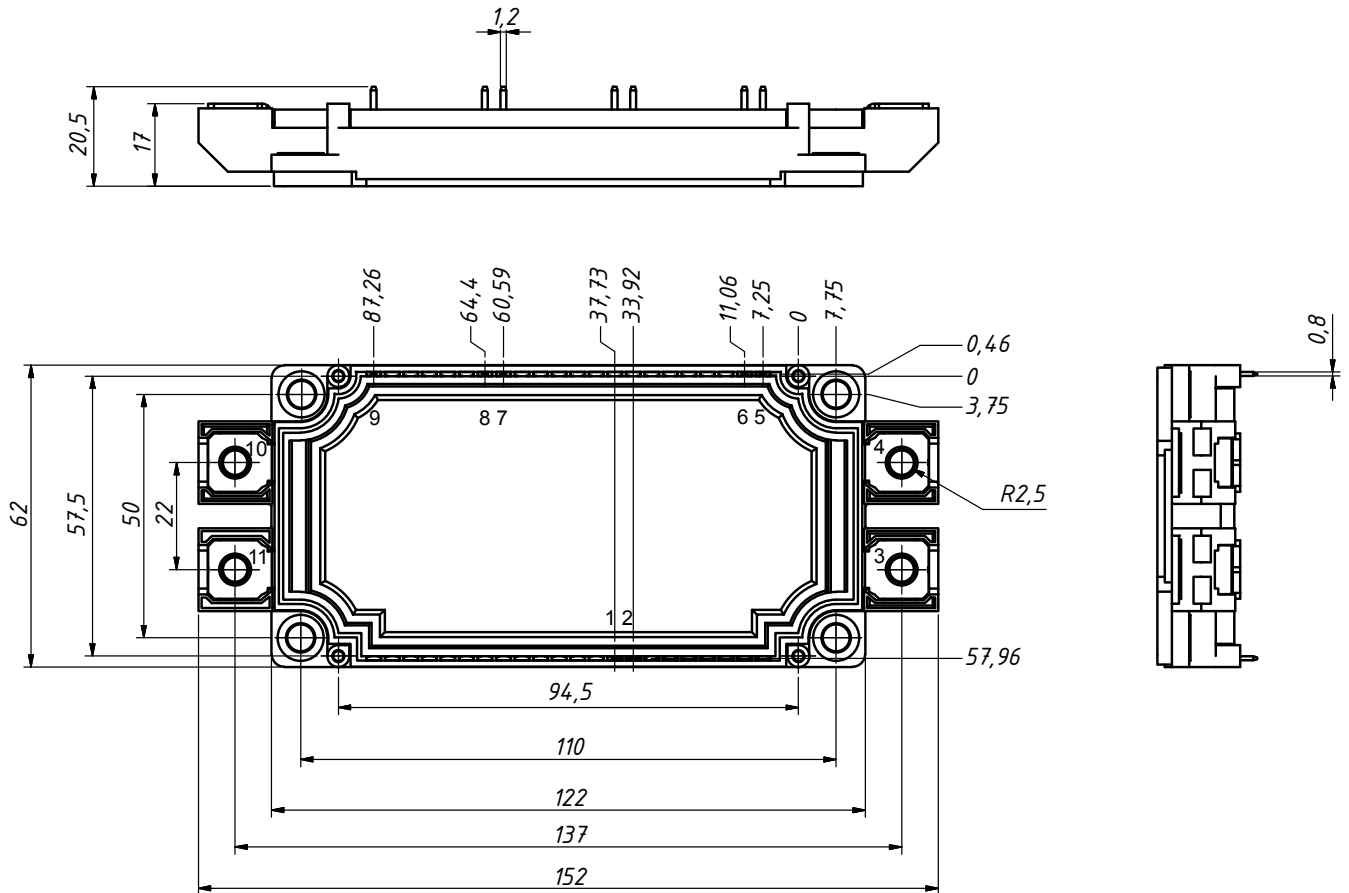

**X144 SimBus P**

Weight = 1200 g

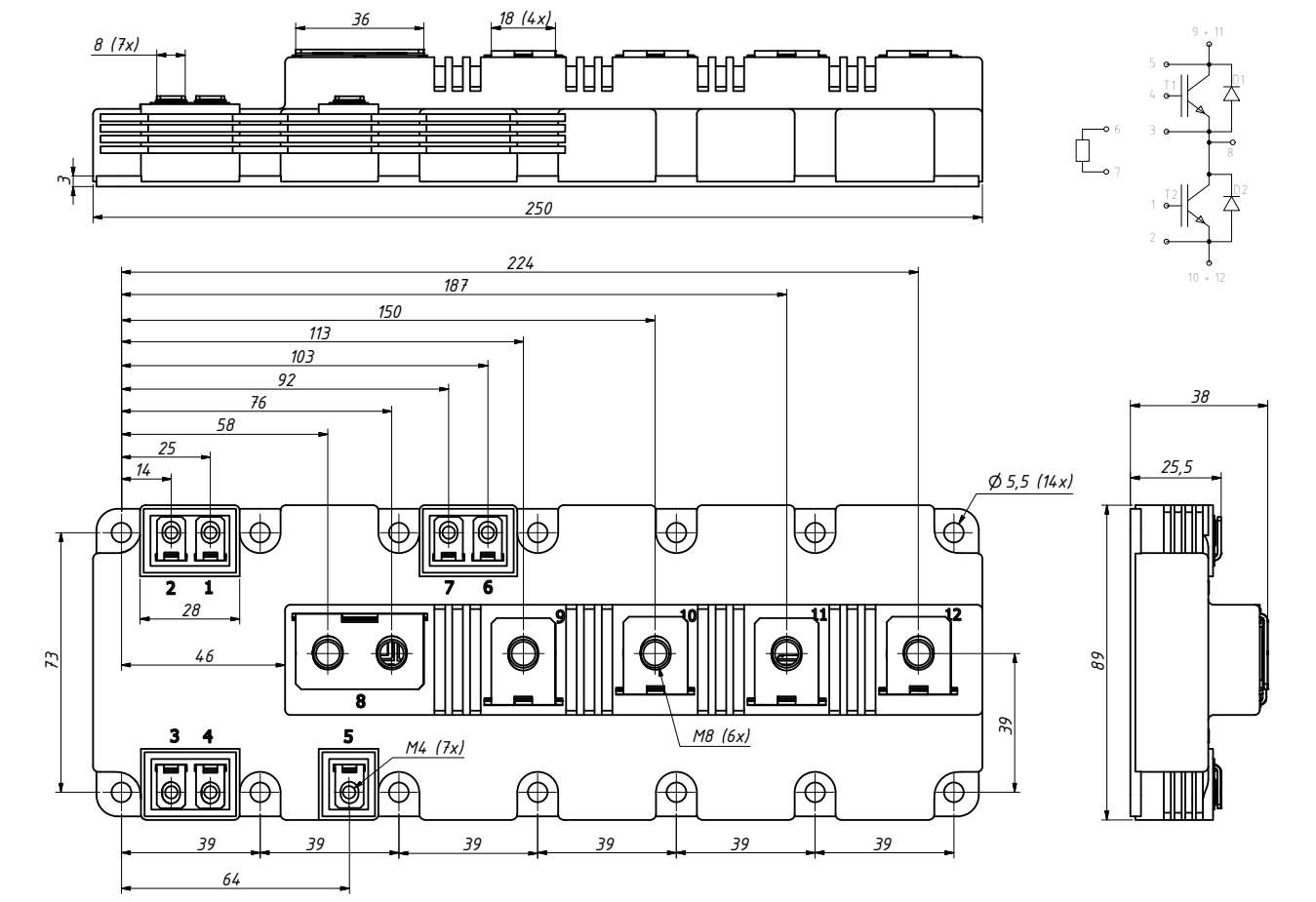

Dimensions in mm and inches (1 mm = 0.0394")

<p><b>X200 Metal-can</b> Weight = 2.5 g</p>	<p><b>X201 FP-Case (oilproof)</b> Weight = 0.9 g</p>	<p><b>X202 BOD-Package</b> Weight = 9.5 g</p>																																																																					
<p><b>X203 TO-204 AE</b> Weight = 18 g</p> <table border="1"> <thead> <tr> <th rowspan="2">Dim.</th> <th colspan="2">Millimeter</th> <th colspan="2">Inches</th> </tr> <tr> <th>Min.</th> <th>Max.</th> <th>Min.</th> <th>Max.</th> </tr> </thead> <tbody> <tr> <td>A</td> <td>38.61</td> <td>39.12</td> <td>1.520</td> <td>1.540</td> </tr> <tr> <td>B</td> <td>-</td> <td>22.22</td> <td>-</td> <td>0.875</td> </tr> <tr> <td>C</td> <td>6.40</td> <td>11.4</td> <td>0.252</td> <td>0.449</td> </tr> <tr> <td>D</td> <td>1.45</td> <td>1.60</td> <td>0.057</td> <td>0.063</td> </tr> <tr> <td>E</td> <td>1.52</td> <td>3.43</td> <td>0.060</td> <td>0.135</td> </tr> <tr> <td>F</td> <td colspan="2">30.15 BSC</td> <td colspan="2">1.187 BSC</td> </tr> <tr> <td>G</td> <td>10.67</td> <td>11.17</td> <td>0.420</td> <td>0.440</td> </tr> <tr> <td>H</td> <td>5.21</td> <td>5.71</td> <td>0.205</td> <td>0.225</td> </tr> <tr> <td>J</td> <td>16.64</td> <td>17.14</td> <td>0.655</td> <td>0.675</td> </tr> <tr> <td>K</td> <td>11.18</td> <td>12.19</td> <td>0.440</td> <td>0.480</td> </tr> <tr> <td>Q</td> <td>3.84</td> <td>4.19</td> <td>0.151</td> <td>0.165</td> </tr> <tr> <td>R</td> <td>25.16</td> <td>26.66</td> <td>0.991</td> <td>1.050</td> </tr> </tbody> </table>	Dim.	Millimeter		Inches		Min.	Max.	Min.	Max.	A	38.61	39.12	1.520	1.540	B	-	22.22	-	0.875	C	6.40	11.4	0.252	0.449	D	1.45	1.60	0.057	0.063	E	1.52	3.43	0.060	0.135	F	30.15 BSC		1.187 BSC		G	10.67	11.17	0.420	0.440	H	5.21	5.71	0.205	0.225	J	16.64	17.14	0.655	0.675	K	11.18	12.19	0.440	0.480	Q	3.84	4.19	0.151	0.165	R	25.16	26.66	0.991	1.050	<p><b>X204 DO-203 AA [M] (DO-4)</b> Weight = 6 g</p>	<p><b>X205 DO-203 AA [UNF] (DO-4)</b> Weight = 5.5 g</p>
Dim.		Millimeter		Inches																																																																			
	Min.	Max.	Min.	Max.																																																																			
A	38.61	39.12	1.520	1.540																																																																			
B	-	22.22	-	0.875																																																																			
C	6.40	11.4	0.252	0.449																																																																			
D	1.45	1.60	0.057	0.063																																																																			
E	1.52	3.43	0.060	0.135																																																																			
F	30.15 BSC		1.187 BSC																																																																				
G	10.67	11.17	0.420	0.440																																																																			
H	5.21	5.71	0.205	0.225																																																																			
J	16.64	17.14	0.655	0.675																																																																			
K	11.18	12.19	0.440	0.480																																																																			
Q	3.84	4.19	0.151	0.165																																																																			
R	25.16	26.66	0.991	1.050																																																																			

Dimensions in mm and inches (1 mm = 0.0394")

<p><b>X206a DO-203 AB [UNF] (DO-5)</b>  <b>X206b DO-203 AB [M] (DO-5)</b>                  Weight = 14 g</p>	<p><b>X207 DO-203 AB (DO-5)</b> Weight = 20 g</p>	<p><b>X209 TO-208 AA (TO-48)</b> Weight = 11.6 g</p>
<p><b>X210 TO-208 AC (TO-65)</b> Weight = 21.7 g</p>		

Dimensions in mm and inches (1 mm = 0.0394")

<p><b>X251 UGE-single</b> Weight = 125 g</p>	<p><b>X252 UG</b> Weight = 155 g</p>	<p><b>X253a UG</b> Weight = 310 g b: w/o middle terminal</p>																																																							
<table border="1"> <thead> <tr> <th>Type</th> <th>a</th> <th>b</th> <th>c</th> <th>d</th> <th>e</th> <th>f</th> <th>g</th> <th>h</th> <th>i</th> <th>k</th> </tr> </thead> <tbody> <tr> <td>UGB 3132 AD</td> <td>80</td> <td>70</td> <td>57</td> <td>58.5</td> <td>260</td> <td>6</td> <td>15</td> <td>15</td> <td>15</td> <td></td> </tr> <tr> <td>UGB 6124 AG</td> <td>135</td> <td>125</td> <td>112</td> <td>58.5</td> <td>260</td> <td>11</td> <td>32.5</td> <td>25</td> <td>32.5</td> <td></td> </tr> <tr> <td>UGD 6123 AG</td> <td>135</td> <td>125</td> <td>112</td> <td>58.5</td> <td>260</td> <td>8</td> <td>30</td> <td>18</td> <td>18</td> <td>30</td> </tr> <tr> <td>UGD 8124 AG</td> <td>135</td> <td>125</td> <td>112</td> <td>58.5</td> <td>260</td> <td>8</td> <td>30</td> <td>18</td> <td>18</td> <td>30</td> </tr> </tbody> </table>			Type	a	b	c	d	e	f	g	h	i	k	UGB 3132 AD	80	70	57	58.5	260	6	15	15	15		UGB 6124 AG	135	125	112	58.5	260	11	32.5	25	32.5		UGD 6123 AG	135	125	112	58.5	260	8	30	18	18	30	UGD 8124 AG	135	125	112	58.5	260	8	30	18	18	30
Type	a	b	c	d	e	f	g	h	i	k																																															
UGB 3132 AD	80	70	57	58.5	260	6	15	15	15																																																
UGB 6124 AG	135	125	112	58.5	260	11	32.5	25	32.5																																																
UGD 6123 AG	135	125	112	58.5	260	8	30	18	18	30																																															
UGD 8124 AG	135	125	112	58.5	260	8	30	18	18	30																																															

Dimensions in mm

<p><b>X254 VG-A</b> Weight = 61 g</p>	<p><b>X255 VG-B</b> Weight = 87 g</p>	<p><b>X256 VG-C</b> Weight = 50 g</p>
---------------------------------------	---------------------------------------	---------------------------------------

Dimensions in mm and inches (1 mm = 0.0394")

### X502 8-Pin P-DIP

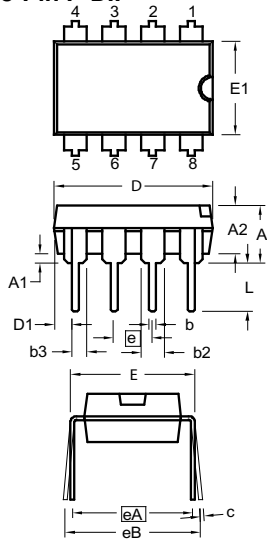

Dim.	Millimeter		Inches	
	min	max	min	max
A	3.56	4.57	0.140	0.180
A1	0.38	1.02	0.015	0.040
A2	3.18	3.68	0.125	0.145
b	0.38	0.51	0.015	0.020
b2	1.40	1.65	0.055	0.065
b3	0.89	1.14	0.035	0.045
c	0.23	0.30	0.009	0.012
D	9.02	10.16	0.355	0.400
D1	0.25	1.02	0.010	0.040
E	7.62	8.26	0.300	0.325
E1	6.10	6.86	0.240	0.270
e	2.54 BSC		0.100 BSC	
eA	7.62 BSC		0.300 BSC	
eB	7.62	10.92	0.300	0.430
L	3.05	3.56	0.120	0.140

### X512 8-pin SOIC/SOP X512a 8-pin SOIC-CT/SOP-CT

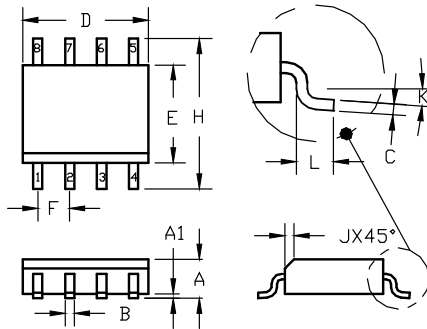

Dim.	Millimeter		Inches	
	min	max	min	max
A	1.35	1.75	0.053	0.069
A1	0.10	0.25	0.004	0.010
B	0.33	0.51	0.013	0.020
C	0.19	0.25	0.007	0.010
D*	4.80	5.00	0.189	0.197
E*	3.80	4.00	0.150	0.158
E1	6.10	6.86	0.240	0.270
F	1.27 BSC		0.050 BSC	
H	5.8	6.2	0.229	0.244
J	0.25	0.50	0.010	0.020
K	0°	8°	0°	8°
L	0.40	1.27	0.016	0.050

\* do not include Mold protrusions

### X532 8-Pin DFN 4x5

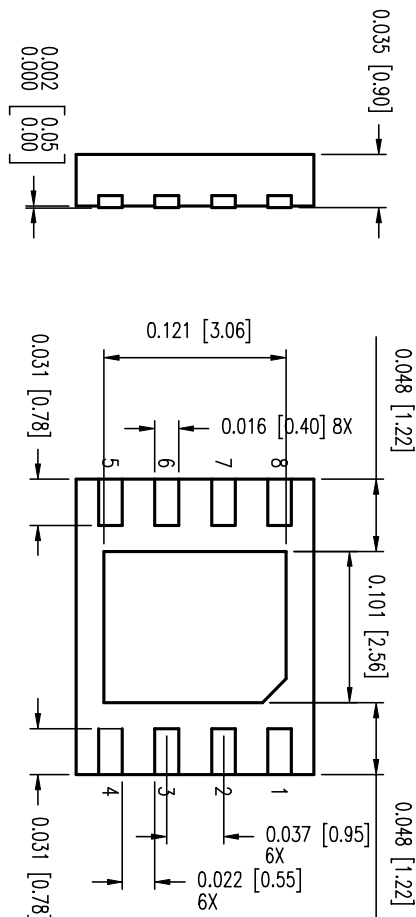

### D5 DE475

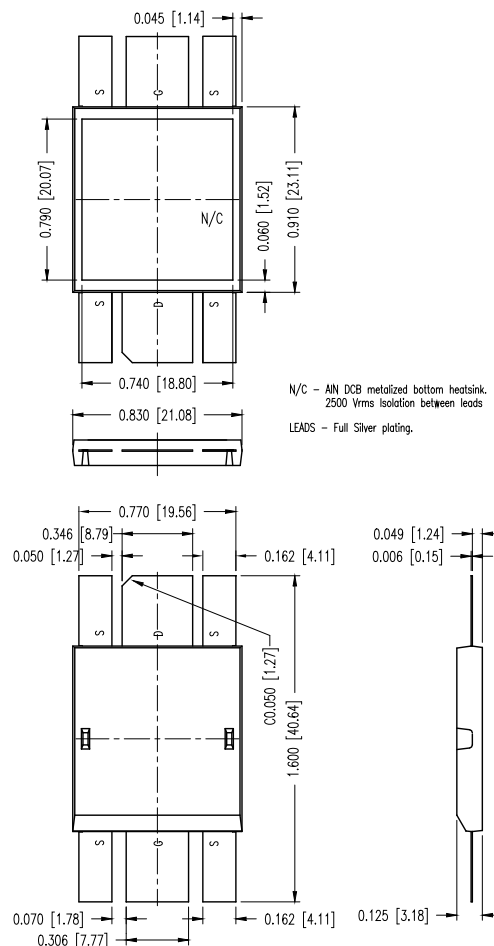

<b>Power Factor Correction</b>	
IXAN0001	3-Phase PFC using Vienna Rectifier Approach and Modular Construction for Improved Overall Performance, Efficiency and Reliability
IXAN0002	Single and Three-Phase Rectifiers with Active Power Factor Correction for Enhanced Mains Power Quality
IXAN0003	Rectifiers with Power Factor Correction
IXAN0004	Design and Experimental Investigation of a Three-Phase, High Power Density, High Efficiency, Unity Power Factor PWM (VIENNA) Rectifier Employing a Novel Integrated Power Semiconductor Module
IXAN0005	Status of the Techniques of Three-Phase Rectifier Systems with Low Effects on the Mains
<b>MOSFETs and IGBTs Drivers</b>	
IXAN0012	MOSFET/IGBT Drivers - Theory and Applications
IXAN0011	Driving Your MOSFETs Wild to Obtain Greater Efficiencies, Power Densities and Lower Overall Cost
<b>BiMOSFETs Applications</b>	
IXAN0013	Capacitor Charge/Discharge Circuits, utilizing High Voltage IGBTs and ZCS Resonant Mode Techniques
IXAN0014	Comparative Performance of BiMOSFETs in Fly-back Converter Circuits
IXAN0015	Use of BiMOSFETs in Modern Radar Transmitters
IXAN0016	IXBH40N160 BiMOSFET Developed for High Voltage and High Frequency Applications
IXAN0017	New 1600V BiMOSFET Transistors Open Up New Applications
<b>Automotive Applications</b>	
IXAN0018	A High Current Dual Inline Packaged Trench MOSFET Three Phase Full Bridge as Contribution to Automotive System Integration
IXAN0019	High Power TrenchMOSFETs Solutions in Automotive Designs
IXAN0020	Power Electronic Supply for Automotive Starter Generator
IXAN0021	New Trench Power MOSFETs in Isolated Packages
<b>Isolation Techniques, Mounting, Soldering and Cooling</b>	
IXAN0071	The SMPD Package and its Mounting Instructions
IXAN0022	Capitalizing on the Advantages of ISOPLUS Products
IXAN0023	General Mounting Instructions
IXAN0025	ISOPLUS-The Revolution in Discrete Isolation Technique
IXAN0026	Combining the Features of Modules and Discretes in a New Power Semiconductor Packages
IXAN0028	The Revolution in Discrete Isolation Technique
IXAN0030	Surface Mount Soldering Recommendations for TO-263 and TO-268 case styles
IXAN0031	New ISOPLU247 Power Package Features 2500V Internal Isolation Revolutionary Approach Improves Thermal Conductance and Reliability
<b>Power Modules</b>	
IXAN0034	Recommended Use of the Integrated NTC Thermistor Temperature Sensor in IXYS Power Modules
IXAN0035	Mounting Instructions for _A7, _E7, _A8 and _E8 Module Series
IXAN0036	Investigations on Electromagnetic Compatibility of Power Semiconductor Modules Integrated in a Module
IXAN0037	Power Cycle Capability of solder contact DCB-Modules
<b>FREDs and Schottky Diodes</b>	
IXAN0042	Is the Lowest Forward Voltage Drop Schottky Diode Always the Best Choice?
IXAN0043	Input Rectifiers with Semifast Diodes for DC link.
IXAN0044	Characteristics and Applications of Fast Recovery Epitaxial Diodes.
IXAN0060	Optimized Ultra Fast Diodes for Switching Applications
<b>Power MOSFETs</b>	
IXAN0057	Series Operation of MOSFET and IGBT Switches
IXAN0061	Power MOSFET Basics
IXAN0062	IXYS Power MOSFET Products
IXAN0063	Application note on Depletion-mode
IXAN0064	IXYS P-Channel MOSFET
IXAN0065	IXYS Power MOSFET Datasheet Parameters Definition
IXAN0068	Linear Power MOSFETS Basic and Application
IXAN0069	Synchronous DC to DC Converter Design
<b>IGBTs</b>	
IXAN0063	IGBTs
IXAN0070	Drive with the IXYS XPT IGBT
IXAN0072	Discrete 600V GenX3 XPT IGBTs